



Actros, Arocs, Antos

Operating Instructions

Mercedes-Benz



Symbols

WARNING

Warning notes make you aware of dangers which could pose a threat to your health or life, or to the health and life of others.

Environmental note

Environmental notes provide you with information on environmentally aware actions or disposal.

 Notes on material damage alert you to dangers that could lead to damage to your vehicle.

 Useful instructions or further information that could be helpful to you.

▶ This symbol designates an instruction you must follow.

▶ Several consecutive symbols indicate an instruction with several steps.

(▷ page) This symbol tells you where you can find further information on a topic.

▷ ▷ This symbol indicates a warning or an instruction that is continued on the next page.

Display This text indicates a message on the display.

Welcome to the world of Mercedes-Benz

Before you first drive off, read these Operating Instructions carefully and familiarise yourself with your vehicle. For your own safety and a longer vehicle life, follow the instructions and warning notes in these operating instructions. Disregarding them may lead to damage to the vehicle or personal injury.

The standard equipment and product description of your vehicle may vary, depending on:

- model
- order
- country variant
- availability

The illustrations in these Operating Instructions show a left-hand-drive vehicle. In right-hand-drive vehicles, the arrangement and location of vehicle parts and controls differ accordingly.

Mercedes-Benz is constantly updating its vehicles to the state of the art.

Mercedes-Benz reserves the right to introduce changes in the following areas:

- design
- equipment
- technical features

Descriptions may therefore differ from your vehicle in individual cases.

The following are integral parts of the vehicle:

- Operating Instructions
- Maintenance or Service Booklet
- Supplements relating to vehicle equipment

Keep these documents in the vehicle at all times. If you sell the vehicle, always pass the documents on to the new owner.

You can also use the smartphone App, Mercedes-Benz Guide:



Apple® iOS



Android™

Please note, the Mercedes-Benz Guide App may not yet be available in your country.

The technical documentation team at Daimler AG wishes you safe and pleasant motoring.

Index	4	Voltage supply	102
Introduction	28	Practical tips	105
Operating Instructions	28	Communications	112
Correct use	28	Climate control	116
Protection of the environment	29	Useful information	116
Operating safety and vehicle registra- tion	29	General notes	116
Genuine Mercedes-Benz parts	33	Overview of climate control system functions	116
Data stored in the vehicle	33	Switching the cooling with air dehu- midification function on/off	118
At a glance	36	Setting climate control to automatic ...	119
Cockpit	36	Setting the temperature	120
Overhead control panel	38	Adjusting the air vents	120
Instrument cluster	40	Setting the air distribution	121
Switch units	43	Setting the airflow	121
Multifunction steering wheel	47	Demisting the windscreen and win- dows	121
Combination switch and multifunc- tion lever	48	Switching air recirculation mode on/ off	122
Safety	49	Switching residual engine heat utilis- ation on/off	122
Useful information	49	Switching the auxiliary ventilation on/ off	122
Occupant safety	49	Electrical auxiliary air conditioning	123
Children in the vehicle	54	Auxiliary heating	125
Pets in the vehicle	56	On-board computer and displays	128
Opening and closing	57	Useful information	128
Useful information	57	Instrument cluster	128
Locking system	57	On-board computer	133
Getting into/out of the vehicle	66	On-board computer event window	152
Side windows	67	Indicator lamps in the status area of the display	187
Roof	68	FleetBoard	190
Roller sunblind	71	Useful information	190
Driver's workstation	73	Important safety notes	190
Useful information	73	FleetBoard vehicle computer with integrated card reader	190
Seats	73	FleetBoard vehicle computer with driver card	194
Beds in an L cab	77	FleetBoard Truck Data Center 6 (DTCO)	196
Berths in an M cab	83	FleetBoard Truck Data Center 6 (FB Card)	199
Adjusting the multifunction steering wheel	84		
Adjusting the exterior mirrors	85		
Lighting system	86		
Good visibility	101		

FleetBoard Support	202	Wind deflector	331
		Winter operation	336
DispoPilot.guide	204		
Important safety notes	204	Working mode	341
Note on the Brief Instructions	204	Useful information	341
Declaration of conformity	204	Power take-offs	341
Electromagnetic compatibility	204	Tipper operation	345
Transmitter frequencies	205		
Operation restriction	206	Maintenance and care	348
Availability	206	Useful information	348
First steps	206	Cleaning and care	348
Overview	207	Maintenance	354
Basic functions	208		
Navigation	209	Breakdown assistance	369
Practical advice	213	Useful information	369
		Telediagnosis	369
Multimedia systems	214	Where will I find...?	369
Important safety notes	214	Cab	372
General notes	214	Engine	376
Anti-theft protection	215	Flat tyre	380
Operating system	216	Electrical fuses	386
Audio mode	223	Charging the compressed-air system ..	394
Bluetooth® settings	224	Jump-starting, tow-starting and tow- ing away	395
Navigation	225		
Digital Operating Instructions	227	Wheels and tyres	402
		Useful information	402
Multimedia Radio Touch	230	Operating and road safety	402
Important safety notes	230	Tyre pressures	404
General notes	231	Tyre pressure table for single tyres	406
Screen operation	231	Tyre pressure table for twin tyres	411
Driving mode	236	Technical data	417
Useful information	236	Useful information	417
Driving	236	Vehicle identification plate/axle loads	417
Brakes	244	Engine data plate	418
Manual transmission	251	Service products	418
Automated transmission	253	Operating data	426
Automatic transmission	262	Compressed-air reservoir	428
Operation	264		
Driving systems	274		
Level control	295		
Additional axles	300		
Driving tips	302		
Refuelling	315		
Trailers/semitrailers	319		

- 1, 2, 3 ...**
- 9 gear transmission**
 General notes 252
- 9-speed transmission**
 Change shift range 252
- 16-speed transmission**
 Manual transmission 252
- A**
- ABS (Anti-lock Braking System)**
 Braking with anti-lock protection ... 245
 Deactivating/activating 246
 Display check 245
 General information 245
- Acceleration skid control**
 see ASR (Acceleration skid control)
- Access steps**
 Cleaning 350
 Important safety notes 350
- Active Brake Assist**
 Activating/deactivating 286
 Collision warning and emergency
 braking 286
 Important safety notes 284
 Particular driving situations 287
- Active Brake Assist cannot be activated**
 Grey display message 154
- Active Brake Assist not available**
 Yellow display message 167
- AdBlue almost empty**
 Yellow display message 158
- AdBlue empty**
 Yellow display message 158
- AdBlue reserve**
 Yellow display message 158
- AdBlue®**
 Additive 425
 Consumption 313
 Disposal 426
 Gauge 129
 General notes 425
 High outside temperatures 425
 Important safety notes 318
 Low outside temperatures 425
 Purity 426
- Refuelling 318
 Service product 425
 Storage 425
- AdBlue® tank** 318
- Additional axle**
 Leading axle 300
 Leading/trailing axle (steerable) 301
 Starting-off aid 300
 Steerable 301
 Trailing axle 300
- Additional axle raised**
 Yellow display message 166
- Address (navigation)**
 Entering 226
- Adjustable backrest**
 Setting 79
- Adjusting the volume**
 Audio equipment 142
 Radio 142
- Air conditioning**
 General notes 116
- Air distribution**
 Setting (automatic climate control) 121
 Setting (heating/air conditioning) 121
- Air drier**
 Checking 241
- Air filter maintenance due**
 Grey display message 157
- Air filter maintenance due date**
 Grey display message 157
- Air pressure**
 see Tyre pressure
- Air regulation system**
 Opening and locking 379
- Air-recirculation mode**
 Activating/deactivating 122
- Airbag**
 Introduction 52
- Airbags**
 Driver's 53
 Important safety guidelines 52
 Triggering 53
- Airflow**
 Setting (automatic climate control) 121

- Setting (heating/air conditioning) 121
- Alarm**
- Operating (on-board computer) 140
- Ambient lighting**
- Switching on/off 90
- Anti-lock braking system**
- see ABS (Anti-lock Braking System)
- Anti-skid chains**
- see Snow chains
- Articulation angle** 320
- Ashtray** 105
- ASR (Acceleration skid control)**
- Deactivating/activating 266
- Function/Notes 266
- Assembly lever** 370
- ATA (Anti-Theft Alarm system)**
- Activating/deactivating 63
- Alarm 63
- Before priming ATA 63
- Cancelling the alarm 64
- General notes 62
- Priming / deactivating the panic alarm 64
- Priming with interior motion sensor 63
- Priming without interior motion sensor 64
- Problems (malfunction) 66
- Vehicles for transporting hazardous goods 62
- Attachments**
- see Vehicle bodies
- Attachments/add-on equipment** 32
- ATTENTION ASSIST**
- Activating/deactivating (on-board computer) 151
- Cleaning the camera 352
- Function/notes 291
- ATTENTION ASSIST: take a break?**
- Yellow display message 167
- Audio equipment**
- Adjusting the volume (steering wheel buttons) 142
- General information 113
- Operating (berth switch unit) 113
- Operating (on-board computer) 142
- Audio system**
- Bluetooth® settings 224
- General notes 214
- Important safety notes 214
- Operating system (overview) 216
- Selecting an audio source 223
- Automatic car wash** 353
- Automatic transmission**
- Accelerator pedal position 263
- Checking the oil level 360
- Drive programs 263
- Driving tips 263
- Gear indicator 262
- Important safety notes 262
- Kickdown 263
- Manoeuvring 264
- Mercedes PowerShift 253
- Pulling away 263
- Rocking free 264
- Shift ranges 262
- Stopping 263
- Touch-key gearshift 262
- Auxiliary air conditioning**
- General notes 123
- Immediate cooling mode 124
- Setting the air distribution 123
- Setting the switch-on time 124
- Switch 124
- Auxiliary heating**
- Engine preheating 125
- Immediate heating mode 126
- Important safety notes 125
- Mandatory switch-off 125
- Setting the switch-on time 126
- Switch 126
- Auxiliary ventilation**
- Activating/deactivating 122
- Axle load**
- Notes on axle and wheel loads 266
- Axle loads**
- Adjusting the display (on-board computer) 144
- Checking (on-board computer) 143
- Permissible axle loads 417
- Axle reduction ratio** 417

- B**
- BAS (Brake Assist)** 246
- Battery**
- Charging 206
 - Inserting 206
 - Replacing 213
- Battery (vehicle)**
- Battery case 363
 - Battery isolator switch 102
 - Care 368
 - Charging 367
 - Checking the fluid level 367
 - Disconnecting and connecting 364
 - Important safety notes 362
 - Jump starting 395
 - Notes/maintenance 366
 - Removing/fitting 365
- Battery charge level low**
- Yellow display message 173
- Battery charge level not available**
- Yellow display message 173
- Battery charge level too low Start engine**
- Yellow display message 173
- Battery isolator switch** 102
- Beacon** 43
- Beds in the L cab**
- Climbing aids 77
 - Lower 78
 - Seat/berth combination 79
 - SoloStar Concept 82
 - Upper, narrow 77
- Before pulling away**
- Checking the supply pressure in the compressed-air brake system .. 241
 - Important safety notes 239
- Belt tensioner**
- Activation 53
- Belt warning** 52
- Berth**
- Switch units 46
- Berths in an M cab**
- Lower 83
 - Overview 83
 - Padded stowage space 83
- Berths in the L cab**
- see L cab beds
- Berths in the M cab**
- see Berths in an M cab
- Bi-xenon headlamps**
- Notes on replacing bulbs 91
- Bleeding the fuel system**
- Bleeding with the hand pump (with fuel prefilter) 378
 - Bleeding with the hand pump (without fuel prefilter OM 460) 376
 - Bleeding with the hand pump (without fuel prefilter OM 470/471/473) 377
 - Bleeding with the starter motor (without fuel prefilter OM 963) 378
 - Draining the fuel prefilter 378
- BlueTec® exhaust gas aftertreatment**
- AdBlue® service product 425
 - Notes 31
 - Status indicator 133
- Bluetooth®**
- Activating/deactivating 224, 233
 - Authorising (registering) a device .. 233
 - Connecting devices 224
 - Connection requirements 224, 232
 - De-authorising (de-registering) a device 233
 - Notes 224
 - Searching for devices 233
 - Settings 224
- Bonnet**
- see Maintenance flap
- Brake lamp**
- Replacing bulbs 97
- Brake pads completely worn**
- Yellow display message 167
- Brake supply pressure in circuit 1 too low**
- Red display message 177
- Brake system**
- Checking for leaks 244
 - Service brake 244
 - Technical data 426
- Brakes**
- Checking for leaks in the compressed-air brake system 244
 - Frequent-stop brake 248

- Hill holder 249
 Independent trailer brake 247
 Releasing the spring-loaded parking brake 400
- Brakes, axle 1 Maintenance due immediately**
 Yellow display message 167
- Braking**
 ABS 245
 ABS display check 245
 Anti-lock protection 245
 BAS 246
 Brake system 244
 Continuous brake 250
 Engine brake 251
 Parking brake 247
 Retarder 251
- Braking effect limited**
 Yellow display message 167
- Breakdown assistance**
 Assembly lever 370
 Bleeding the fuel system 376
 Bulb 370
 Cab tilting pump wrench 371
 Cable lamp 370
 Chock 372
 Fire extinguisher 370
 First-aid kit 370
 Flat tyre 380
 Important safety notes 369
 Jack 370
 Pump lever 371
 Reflective safety jacket 370
 Releasing the spring-loaded parking brake 400
 Spare bulbs 370
 Starting and stopping the engine with the cab tilted 376
 Telediagnosis 369
 Tilting the cab 372
 Tyre inflator hose 370
 Tyre pressure gauge 370
 Warning lamp 370
 Warning triangle 370
 Wheel wrench 371
- Bulb**
 Roof position marker lamps 97
- Bulbs**
 Spare bulbs 370
- Buttons**
 see On-board computer
- C**
- Cab**
 Electrohydraulic cab tilting system 374
 Mechanical-hydraulic cab tilting system 373
 Notes on tilting 372
 Problems in tilting the cab 375
- Cable lamp** 370
- Cables and compressed-air lines**
 Connecting 324
 Disconnecting 324
- Camera's optical field of vision dirty**
 Yellow display message 167
- Care**
 Exterior lighting 352
 see Cleaning and care
- Care products** 348
- CD radio**
 Anti-theft protection 215
 Bluetooth® settings 224
 Display (overview) 220
 Function overview 220
 Operating system (overview) 219
 Symbols (overview) 221
- Central locking**
 Enhanced central locking system 62
 Problems with the locking system ... 66
- Central locking system**
 Exterior door lock 61
 Internal door lock 61
 Problems (malfunction) 66
- Changing a bulb**
 Foglamp (variant 1) 96
 Foglamp (variant 2) 97
 Overview of bulbs 92
 Reading lamp (bed/berth) 98
 Side marker lamp (rear lamp cluster) 97
 Side marker lamp (side turn signal lamp) 96

- Turn signal lamp (headlamp) 96
- Turn signals (rear lamp cluster) 97
- Changing a wheel**
 - Fitting a wheel 385
 - Important safety notes 380
 - Notes on the spacer 382
 - Notes on wheels with a tyre pressure sensor 404
 - Positioning a jack 383
 - Removing a wheel 384
 - Removing the spare wheel 382
 - Retightening wheel nuts 386
 - Wheel nuts for light-alloy disc wheels 385
 - Wheel nuts for pressed-steel wheels 385
- Changing bulbs**
 - General notes 91
- Changing direction**
 - Announcement phase 227
 - Change of direction phase 227
- Changing the battery (key)** 65
- Chassis frame**
 - Raising/lowering (level control) 297
 - Storing/calling (level control) 297
- Check semitrailer coupling**
 - Red display message 180
- Check tyre pressure**
 - Yellow display message 166
- Checking the anti-corrosion protection** 362
- Checking the vehicle height** 242
- Checklist**
 - After driving off-road 308
 - Before driving off-road 306
- Child**
 - Restraint system 55
- Children in the vehicle**
 - Important safety notes 54
- Cigarette lighter** 106
- Cleaning and care**
 - Access steps 350
 - After driving off-road or on construction sites 309
 - Automatic car wash 353
 - cleaning seat covers 349
 - Cleaning the camera (Lane Keeping Assist and ATTENTION ASSIST) 352
 - Cleaning the exterior 349
 - Cleaning the interior 348
 - Distance sensor 352
 - Engine cleaning 354
 - High-pressure cleaning 353
 - Light-alloy wheels 354
 - Notes on care 348
 - Rain and light sensor 352
 - Seat belts 349
 - Semi-trailer hydraulic system 329
 - Sideguard Assist sensors 353
- Cleaning the camera**
 - Lane Keeping Assist and ATTENTION ASSIST 352
- Climate control**
 - Activating/deactivating auxiliary ventilation 122
 - Auxiliary air-conditioning 123
 - Auxiliary heating 125
 - Cleaning the coarse filter for heating and climate control 358
 - Controlling automatically 119
 - Demisting the windows 121
 - Overview functions 116
 - Refrigerant 421
 - Refrigerant filling capacity 421
 - Setting the air distribution 121
 - Setting the air vents 120
 - Setting the airflow 121
 - Setting the temperature 120
 - Switching air-recirculation mode on/off 122
 - Switching cooling with air dehumidification on/off 118
 - Switching residual engine heat utilisation on/off 122
- Clutch (hydraulic)** 357
- Clutch actuation system** 357
- Clutch faulty**
 - Red display message 179
 - Yellow display message 164
- Clutch plate oil temperature 180 °C**
 - Yellow display message 164

- Clutch under heavy strain**
 - Grey display message 153
 - Yellow display message 164
- Clutch/transmission circuit**
 - Checking the supply pressure 241
- Coarse filter, heating and climate control** 358
- Cockpit**
 - Overview 36
- Cold start** 337
- Cold-climate package** 337
- Collision warning (Active Brake Assist)**
 - Red display message 182
- Combination switch** 88
 - Overview 48
- Compressed-air brake system**
 - Checking the reservoir pressure 241
- Compressed-air connection**
 - Cab 111
- Compressed-air drier**
 - Checking 241
- Compressed-air lines and cables**
 - Connecting 324
 - Disconnecting 324
- Compressed-air reservoir**
 - General information 428
 - Type plates 429
- Compressed-air system**
 - Charging from an outside source ... 394
 - Minimum pressure 426
 - Reservoir pressure 426
 - Supply connection 394
 - Technical data 426
- Compressed-air system supply connection** 394
- Condensation in compressed-air reservoir**
 - Yellow display message 162
- Connection status** 207
- Constant headlamp mode**
 - see Daytime driving lights
- Consumer shutoff active**
 - Grey display message 155
- Consumption**
 - AdBlue® 313
 - Engine oil 313
- Fuel** 313
- Continuous brake**
 - Activating/deactivating 250
 - Important safety notes 250
- Control unit**
 - Level control 295
- Controller** 221
- Conversions and equipment**
 - see Vehicle bodies
- Conversions/equipment** 32
- Coolant**
 - Additive with antifreeze protection 420
 - Additive without antifreeze protection 420
 - Checking coolant level and topping up 356
- Coolant level too low**
 - Red display message 178
 - Yellow display message 162
- Coolant regulation faulty**
 - Yellow display message 162
- Coolant temperature**
 - Checking (on-board computer) 148
- Coolant temperature too high**
 - Red display message 178
 - Yellow display message 162
- Coolbox** 109
- Cooling**
 - Activating/deactivating with dehumidification 118
- Corner seating**
 - see SoloStar Concept
- Cornering lamps** 88
- Coupling jaw** 398
- Coupling level reached**
 - Grey display message 156
- Crawler mode**
 - Activating/deactivating (button) ... 257
 - Activating/deactivating (on-board computer) 151
 - Drive functions 257
- Cross-axle lock** 268
- Cruise control**
 - Activating 277
 - Activating while driving 277
 - Adjusting the speed tolerance 283

- Deactivating 278
 - Driving 277
 - Driving tips 277
 - Functions and conditions for activation 277
 - Important safety notes 276
 - Overtaking 278
 - Overview 276
 - Selecting 277
 - Setting a speed 277
 - Setting the speed and the speed tolerance 277
 - Cup holders** 111
 - Cyclone dust prefilter** 358
- D**
- Daytime driving lights**
 - Automatic headlamp mode 87
 - Replacing bulbs 95
 - Switching on 87
 - Deactivate shunting level.**
 - Yellow display message 167
 - Declarations of conformity** 30
 - Demisting the windows** 121
 - Destination (navigation)**
 - Entering a destination by address .. 226
 - Diagnostic data**
 - Calling up (on-board computer) 149
 - Diagnostics connection**
 - Operating safety and vehicle approval 30
 - Diagnostics data**
 - Sending 369
 - Dial number** 234
 - Diesel**
 - Refuelling 315
 - Diesel fuels**
 - Fuel additives 424
 - Important safety notes 422
 - Low outside temperatures 423
 - Diesel particle filter**
 - Automatic regeneration 311
 - Blocking regeneration 312
 - Filter replacement 313
 - Important safety notes 311
 - Starting manual regeneration 312
 - Diesel particle filter full**
 - Red display message 176
 - Yellow display message 158
 - Diesel particle filter: fluid level increased**
 - Yellow display message 158
 - Differential lock**
 - see Differential locks
 - Differential locks**
 - Important safety notes 268
 - Digital Operating Instructions** 28
 - Calling up 228
 - Calling up the help function 229
 - Operating 229
 - Overview 228
 - Digital tachograph**
 - Reading out the driver card and sending data 192
 - Dipped-beam headlamp**
 - Switching on/off 86
 - Dipped-beam headlamps**
 - Replacing bulbs 94
 - Display**
 - On-board computer 133
 - Outside temperature 130
 - Radio/navigation 218
 - Setting the language (on-board computer) 150
 - Time 130
 - Total distance recorder 130
 - Trip meter 130
 - DispoPilot.guide**
 - Inserting and removing 206
 - Restarting 213
 - Distance control**
 - see Distance control assistant
 - Distance control assistant**
 - Activating when the vehicle is stationary 280
 - Activating while driving 280
 - Deactivating 282
 - Decreasing/increasing the specified distance 282
 - Distance display (on-board computer) 139
 - Driving 282
 - Functions and conditions for activation 279

- Important safety notes 278
- Increasing/reducing speed 281
- Overview 279
- Particular driving situations 287
- Pulling away and stopping the vehicle 281
- Selecting distance control assistant 280
- Setting speed/speed tolerance/specified minimum distance 281
- Setting the speed tolerance in overrun mode 283
- Distance sensor**
 - Cleaning 352
- Distance sensor dirty**
 - Yellow display message 167
- Do not turn the steering wheel to the stop**
 - Yellow display message 167
- Door lock** 61
- Doors**
 - Access steps (entering and exiting) 66
 - Entering and exiting 66
 - Grab handles (entering and exiting) 66
- Drive control faulty**
 - Yellow display message 162
- Drive functions**
 - Crawler mode 257
 - EcoRoll mode 256
 - Hydromove 265
 - Manoeuvring mode 265
 - Rocking free 258
- Drive program selection**
 - Automatic transmission 263
- Drive programs**
 - Automatic transmission 263
 - Mercedes PowerShift 255
- Driving**
 - ASR (Acceleration skid control) 266
- Driving and braking characteristics changed**
 - Yellow display message 167
- Driving level**
 - Activating (level control) 298
- Driving level below coupling level**
 - Red display message 180
- Driving mode**
 - Differential locks 268
 - Idling speed 274
 - Notes on axle and wheel loads 266
 - Stability Control Assist 267
- Driving off-road**
 - Adjusting underride guard 303
 - Checklist after driving off-road 308
 - Cleaning after driving off-road or on construction sites 309
 - Driving on inclines 307
 - Driving on sand 308
 - Driving through water 307
 - Fording 307
 - Important safety notes 305
 - Rules for off-road driving 306
 - see Off-road driving
- Driving on the left/right**
 - Partially masking headlamps 100
- Driving on the right/left**
 - Partially masking headlamps 100
- Driving style**
 - see Fuel consumption
- Driving systems**
 - Active Brake Assist 284
 - Cruise control 276
 - Distance control assistant 278
 - Introduction 274
 - Lane Keeping Assist 290
 - Sideguard Assist 292
 - Speed limiter 275
- Driving the vehicle**
 - Important safety notes 266
- Driving time**
 - Checking (on-board computer) 137
- Driving tips**
 - Diesel particle filter 311
 - Economical and environmentally-aware driving 309
 - Engine oil consumption 313
 - Semitrailer 320
 - Trailer 320

E

EcoRoll mode

- Activating/deactivating (on-board computer) 151

- Drive functions 256
- Electrical fuses**
 - see Fuses
- Electromagnetic compatibility**
 - Declaration of conformity 30
- Emergency braking finished**
 - Grey display message 154
- Emergency call 999 or 112** 234
- Emergency equipment** 369
- Engage parking brake**
 - Red display message 182
- Engaging the front axle** 271
- Engine**
 - Changing the power output 31
 - Checking the operating hours (on-board computer) 148
 - Cleaning 354
 - Cold start 337
 - Diagnostics indicator lamp 130
 - Oil consumption 313
 - Operating safety 31
 - Rectifying faults 380
 - Setting the oil grade (on-board computer) 150
 - Setting the oil viscosity (on-board computer) 150
 - Starting 240
 - Starting and stopping with the cab tilted 376
 - Stopping 243
 - Technical data 426
- Engine air cleaner**
 - Important safety notes 355
- Engine brake** 251
- Engine cooling faulty**
 - Yellow display message 162
- Engine data plate** 418
- Engine faulty**
 - Yellow display message 162
- Engine idling speed** 274
- Engine maintenance due immediately**
 - Yellow display message 161
- Engine oil**
 - Adjusting the oil quality 420
 - Checking the oil level 360
 - Checking the oil level (on-board computer) 148
 - Consumption 313
 - Filler neck 356
 - Miscibility 420
 - Multi-grade engine oils 419
 - Oil change 419
 - Quality 419
 - Refilling 360
 - SAE classification 419
 - Scope of use 419
 - Setting viscosity (on-board computer) 150
 - Single-grade engine oil 419
- Engine oil filler neck** 356
- Engine oil pressure too low**
 - Red display message 178
- Engine output reduced**
 - Yellow display message 158
- Engine preheating**
 - see Auxiliary heating
- Engine protection: engine power reduced**
 - Yellow display message 162
- Engine run-on** 239
- Engine speed** 128
- Enhanced central locking system** 62
- Equipment** 199
- Equipment and conversions**
 - see Vehicle bodies
- ESP® deactivated Set normal level**
 - Yellow display message 167
- ESP® not available**
 - Yellow display message 167
- Events**
 - Display (on-board computer) 148
- Exhaust filter**
 - see Diesel particle filter
- Exterior lighting**
 - Cleaning 352
 - Light switch 86
 - Notes on replacing bulbs 91
 - Rotating beacon 91
 - Setting delayed switch-off (on-board computer) 149
- Exterior mirror heating** 86

- Exterior mirrors**
 Adjusting 85
 Heating 86
 Important safety notes 85
- F**
- Filling the tank**
 Fuel/AdBlue® tank 315
- Filter replacement**
 Diesel particle filter 313
- Fire extinguisher** 370
- First completely fill the main tank**
 Grey display message 157
- First steps** 206
- First-aid kit** 370
- Flat tyre**
 Red display message 186
 see Changing a wheel
- FleetBoard**
 Data on the driver card 192
 Functions 191
 Important safety notes 190
 Inserting/removing the driver card 191
 Overview 190
 Reading the tachograph driver card and sending data 192, 198
 Sending messages 191
 Troubleshooting 193
- FleetBoard Support** 202
- Flue gas coefficient** 417
- Fluid level**
 Coolant 356
 Hydraulic clutch actuation system 357
- Foglamp**
 Replacing bulbs (variant 1) 96
 Replacing bulbs (variant 2) 97
- Foglamps**
 Switching on/off 87
- Folding ladder** 318
- Folding table** 110
- Fording**
 Off-road 307
- Fording depth** 307
- Frequent-stop brake** 248
- Front bonnet**
 see Maintenance flap
- Fuel**
 Additives 424
 Diesel 422
 FAME fatty acid methyl ester fuel .. 424
 Gauge 129
 Important safety notes 315
 Refuelling 315
- Fuel consumption**
 Automatic fuel consumption optimisation (PPC) 282
 Driving style 313
 Economical driving 309
 General notes 313
 Operating conditions 313
 Vehicle version 313
- Fuel grades**
 Diesel 421
- Fuses**
 Allocation chart 387
 Checking and replacing a safety fuse 394
 Checking and switching on an automatic circuit-breaker 394
 Important safety notes 386
 Removing the main fuse carrier cover 387
- G**
- Gauge**
 AdBlue® 129
 Fuel 129
- Gear indicator**
 Automatic transmission 262
 Mercedes PowerShift 254
- Generator is not charging battery**
 Yellow display message 173
- Genuine Mercedes-Benz parts** 33
- Green light**
 see Nightlight
- Grey display message**
 BlueTec®5 exhaust gas aftertreatment 153
 BlueTec®6 exhaust gas aftertreatment 153
 Driving systems 154

Electrical system and key	155
Engine and cooling	157
Semitrailer	156
Service products and maintenance	157
Transmission and clutch	153
Tyres	156
Grey event window	
Notes	152

H

Hands-free system	
see Mobile phone	
Hazard warning lamps	
Full brake application	244
Headlamp cleaning system	
Operation	102
Topping up fluid	357
Headlamp flasher	88
Headlamp range	149
Headlamps	
Basic setting	417
Changing a bulb	93
Masking partially	100
Notes on winter driving	102
Overview of bulbs	92
Swinging away the protective grid ...	94
Swinging out (variant 1)	93
Swinging out (variant 2)	94
Headlamps (automatic)	87
Heated windscreen	102
High-pressure cleaning	353
Hill holder	249
Home screen	207
Hydraulic additional drive system	
Activating/deactivating	272
Checking the engine oil level	273
Cleaning the radiator and fan	274
Important safety notes	271
Hydraulic clutch actuation system ..	357
Hydraulic fluid	
Checking the fluid level	329
Quality	330
Topping up	329
Hydraulic system	
see Semi-trailer hydraulic system	

Hydrodynamic clutch	
General notes	264
Hydromove	265
Manoeuvring mode	265
Pulling away	264
Hydromove	
Activating/deactivating	151
Drive functions	265

I

Idling speed	
Engine	274
Power take-off	345
Ignition key	
see Key	
Ignition key not correctly inserted	
Yellow display message	173
Ignition lock	237
Ignition run-on	239
Implied warranty	28
Incorrect key	
Yellow display message	173
Increased brake force and pedal travel	
Red display message	182
Independent trailer brake	247
Insect protection on the radiator	32
Insect screen	
Sliding sunroof	69
Instrument cluster	
AdBlue®	129
Displays	40
Fuel gauge	129
Important safety notes	128
Indicator lamps	41
Odometer	130
Rev counter	128
Time and outside temperature	130
Instrument cluster display and controls faulty	
Yellow display message	173
Instrument lighting	
Setting (on-board computer)	149
Inter-axle lock	268
Interior lighting	
Ambient lighting	90
Automatic control (button)	90

- Automatic control system (on-board computer) 149
 - Dimming 89
 - Nightlight (button) 90
 - Nightlight (on-board computer) 149
 - Notes on replacing bulbs 91
 - Reading lamp 90
 - Replacing bulbs 98
 - Switch 89
- J**
- Jack**
 - Declaration of conformity 30
 - Vehicle tool kit 370
 - Jump-start connection**
 - see Jump-starting
 - Jump-starting** 395
- K**
- Key**
 - Changing the battery 65
 - Changing the rechargeable battery 65
 - Multifunction key 57
 - Replacement key 57
 - With remote control 57
 - Key invalid**
 - Yellow display message 173
 - Kickdown** 260
- L**
- L cab beds**
 - Overview 77
 - Upper, car transporter 78
 - Upper, wide 77
 - Lamp check** 58
 - Lane Keeping Assist**
 - Cleaning the camera 352
 - Function/notes 290
 - Lane markings display (on-board computer) 139
 - Lane Keeping Assist faulty**
 - Yellow display message 167
 - Lane Keeping Assist not available**
 - Yellow display message 167
- Language**
 - Setting (on-board computer) 150
 - Laptop holder** 114
 - Leading axle** 300
 - Leading/trailing axle (steerable)** 301
 - Leading/trailing axle centred**
 - Yellow display message 167
 - Level control**
 - Activating (on-board computer) 146
 - Activating driving level 298
 - Control unit 295
 - Forced lowering 298
 - Important safety notes 295
 - Loading/unloading the vehicle when the ignition is switched off ... 298
 - Manoeuvring level 299
 - Operating with the multifunction key 58
 - Operation (on-board computer) 145
 - Raised (vehicles for large-capacity transport, level control) 299
 - Raised vehicle level (vehicles for large-capacity transport) 299
 - Raising/lowering the chassis frame 297
 - Road paver operation 298
 - Storing/calling up chassis frame height 297
 - Technical data 295
 - Licence plate lamp**
 - Replacing bulbs 97
 - Light switch**
 - Overview 86
 - Light-alloy wheels**
 - Cleaning 354
 - Lighting system**
 - Exterior lighting 86
 - Interior lighting 89
 - Light switch 86
 - Masking headlamps partially 100
 - Notes on changing bulbs 91
 - Lights**
 - Automatic headlamp mode 87
 - Cornering light function 88
 - Daytime driving lights 87
 - Dipped-beam headlamps 86
 - Foglamps and rear foglamps 87
 - Headlamp flasher 88

Headlamp range control	149
Main-beam headlamps	88
Limit speed	
Yellow display message	158
Limiter	
Deactivating	276
Loading platform approach aid	331
Loading tailgate	43
Locking system	
ATA (anti-theft alarm system)	62
Central locking system	60
Enhanced central locking system	62
Key	57
Problems with the locking system ...	66
Locking/unlocking the doors	
Inside	61
Outside	61
Lounge seat	
see SoloStar Concept	

M

M cab berths	
Lower, split	84
Main-beam headlamps	
Replacing bulbs	95
Switching on/off	88
Maintenance	
Cleaning the air filter	355
Coolant level	356
Displaying maintenance due date (on-board computer)	147
Hydraulic fluid level	329
Maintenance flap	355
Maintenance system (WS)	354
Notes	354
Semi-trailer hydraulic system	329
Maintenance flap	355
Maintenance points under the maintenance flap	
Coolant	356
Engine oil	356
Windscreen washer system/ headlamp cleaning system washer fluid	356
Maintenance system (WS)	
Due date (on-board computer)	355
Introduction	354

Malfunction	
Display (on-board computer)	148
Malfunction message	
Display (on-board computer)	148
Manoeuvring	
Automatic transmission	264
Manoeuvring level	
Level control	299
Manoeuvring/tow-starting and towing away	
Coupling jaw	398
Notes	397
Manual regeneration not possible	
Grey display message	153
Manual transmission	
9-speed transmission	252
16-speed transmission	252
Changing splitter group (16-speed transmission)	253
Engaging gears	252
Important safety notes	251
Maximum permissible axle loads	
Vehicle identification plate	417
Maximum permissible gross vehicle weight	
Vehicle identification plate	417
Maximum speed	
see Speed limitation	
Mercedes PowerShift	
Activating/deactivating crawler mode (button)	257
Automatic control	259
Automatically shifting into neu- tral	259
Drive functions	255
Drive programs	255
Gear indicator	254
Important safety notes	253
Manual drive program	260
Neutral position	259
Pulling away	258
Reverse gears	261
Stopping	259
Transmission mode selection	256
Mercedes star	
Switching the illumination on/off	91
Mercedes-Benz Service Centre	
see Qualified specialist workshop	

Minimum tyre tread depth	402
Mirrors	
see Exterior mirrors	
Mobile device	
Truck-App	112
Mobile devices	
Authorising (registering)	142
Connecting/disconnecting (on-board computer)	142
Remote Online function	112
Mobile phone	
Connecting to the hands-free system	114
Important safety notes	113
Operating (on-board computer)	141
Multifunction lever	
Overview	48
Multifunction lever and gear indicator	
General notes	254
Multifunction lever	254
Multifunction steering wheel	
Adjusting	84
Overview	47
Multimedia system	
Important safety notes	230

N

Navigation	
Announcement phase (change of direction)	227
Calling up the menu	210
Change-of-direction phase (change of direction)	227
Changing direction	227
Description (lane recommendation)	227
Display (lane recommendation)	227
Displaying route guidance (On-board computer)	139
Entering a destination	226
Entering a destination by address ..	226
Important safety notes	225
Overview	225
Preparation phase (change of direction)	227
Route guidance	226

Switching on	225
Navigation lights	
Replacing bulbs	94
Nightlight	
Switching on/off (button)	90
Switching on/off (on-board computer)	149
Note trailer height	
Yellow display message	166

O

Occupant safety	
Belt warning	52
Children in the vehicle	54
Important safety notes	49
Pets in the vehicle	56
Restraint system introduction	49
Restraint system warning lamp	49
Odometer	
Trip meter	130
Off-road driving	
Checklist before off-road driving	306
Off-road gear	270
Oil	
see Engine oil	
Oil change	419
Oil level	
Checking (automatic transmission)	360
Checking (engine)	360
On-board computer	
Activating backup drive mode (transmission shift system)	140
Activating/deactivating ATTENTION ASSIST	151
Activating/deactivating crawler mode	151
Activating/deactivating EcoRoll mode	151
Activating/deactivating Hydro-move	151
Activating/deactivating PPC	151
Activating/deactivating rocking free	151
Activating/deactivating the automatic interior lighting control	149
Adjusting the axle load indicator ...	144

- Adjusting the headlamp range 149
- Alarm 140
- Areas in the display 134
- Audio and communications menu .. 140
- Blocking diesel particle filter regeneration 151
- Calling up the diagnostic data 149
- Calling up/resetting trip computer 137
- Calling up/resetting trip data 137
- Checking driving time 137
- Checking the axle load 143
- Checking the coolant temperature 148
- Checking the engine operating hours 148
- Checking the oil level 148
- Checking the range 138
- Checking the reservoir pressure 148
- Checking the rest period 137
- Checking tyre pressure 144
- Connecting/disconnecting mobile devices 142
- Controls 133
- Displaying camera image 140
- Displaying economic driving style (FleetBoard EcoSupport) 138
- Displaying events 148
- Displaying maintenance due date .. 147
- Displaying route guidance (navigation) 139
- Displaying trailer/semitrailer data 147
- Displaying vehicle speed 138
- Distance display (distance control assistant) 139
- Driving mode menu 138
- Event window (display messages) .. 152
- Lane markings display (Lane Keeping Assist) 139
- Layout 133
- Menus at a glance 135
- Monitoring info 148
- Notes on messages 152
- Operating level control 145
- Operating the audio equipment 142
- Operating the telephone 141
- Operation and maintenance menu 143
- Overview of warning and indicator lamps 187
- Setting delayed switch-off, exterior lighting 149
- Setting instrument lighting 149
- Setting the display language 150
- Setting the engine oil grade 150
- Setting the engine oil viscosity 150
- Setting the rear axle oil grade 151
- Setting the transmission oil grade .. 151
- Setting the unit of measurement ... 149
- Setting the units 149
- Setting the video popup function ... 151
- Settings menu 149
- Starting diesel particle filter regeneration 151
- Switching the nightlight on/off 149
- Time 137
- Total distance recorder 137
- Trip data menu 137
- Trip meter 137
- Tyre pressure loss warning 145
- Opening/closing the roof hatch** 71
- Operating and road safety** 402
- Operating hours**
 - Checking (on-board computer) 148
- Operating Instructions**
 - Before the first journey 28
 - Digital and printed operating instructions 28
 - General notes 28
 - Implied warranty 28
 - Vehicle equipment 28
- Operating safety**
 - Implied warranty 28
- Operating safety and registration**
 - Attachments/add-on equipment 32
 - BlueTec[®] exhaust gas aftertreatment 31
 - Changes in engine performance 31
 - Installations and conversions 32
 - Notes on body/equipment mounting directives 32
- Operating safety and vehicle approval**
 - Correct use 28

- Declaration of conformity 30
 - Notes on operating the vehicle 29
 - Qualified specialist workshops 31
 - Registering your vehicle 31
 - Operating system**
 - see On-board computer
 - Operating temperature (coolant temperature)** 427
 - Operating the touchscreen**
 - Confirming the selection 231
 - Outside temperature display** 130
 - Overview** 207
- P**
- Panic alarm** 64
 - Parking brake**
 - see Spring-loaded parking brake
 - Parking up the vehicle**
 - Notes on the battery 366
 - Notes on the hydraulic system 330
 - Special measures 368
 - Perimeter/side marker lamps**
 - Replacing bulbs 97
 - Pets in the vehicle** 56
 - PIN**
 - Entering 232
 - Please insert key again**
 - Grey display message 155
 - Please replace ignition key battery**
 - Yellow display message 173
 - Pop-up roof**
 - Closing manually 70
 - Opening/closing 68
 - Roller blinds 69
 - Power steering: function not assured**
 - Red display message 182
 - Power take-off**
 - Constant engine speed 345
 - Disengaging 343
 - Emergency mode 343
 - Engaging 342
 - Engine idling speed 345
 - Engine speed setting 345
 - Gearshift indicator 342
 - General notes 341
 - On the engine 341
 - Preselecting working speed 342
 - Transmission-driven 341
 - Transmission-independent 341
 - Power windows**
 - see Side windows
 - Power-steering assistance overheated**
 - Red display message 182
 - PowerShift**
 - see Mercedes PowerShift
 - PPC (Predictive Powertrain Control)**
 - Activating/deactivating (on-board computer) 151
 - Function 282
 - Setting the speed tolerance 283
 - Preparing for a journey**
 - Vision and function check in vehicle 237
 - Visual and function check on the vehicle exterior 236
 - Press and hold EMERGENCY OFF button for 3 s**
 - Grey display message 155
 - Press shunting switch faster**
 - Grey display message 153
 - Press shunting switch for longer**
 - Grey display message 153
 - Protection of the environment**
 - General notes 29
 - Protective grid**
 - Headlamps 94
 - Sliding sunroof 69
 - Protective grille**
 - Rear lamp cluster 97
 - Pulling away**
 - Notes 242
 - Pump lever** 371
- Q**
- Qualified specialist workshop** 31
- R**
- Radiator cover** 32
 - Radiator shutters inoperative**
 - Grey display message 157

- Radio**
 - Adjusting the volume 142
 - Anti-theft protection 215
 - Changing the audio source or title/station 142
 - Function overview 223
 - General notes 113
 - Operating system (overview) 222
 - Setting the waveband 234
- Radio controls overview**
 - Radio/navigation 216
- Radio display** 234
- Radio-based vehicle components**
 - Declaration of conformity 30
- Radio/navigation**
 - Anti-theft protection 215
 - Bluetooth® settings 224
 - Display (overview) 218
 - Function overview 217
 - Operating system (overview) 216
 - Symbols (overview) 218
- Rain and light sensor**
 - Cleaning 352
- Range**
 - Checking (on-board computer) 138
- Reading lamp**
 - Dimming (driver's/co-driver's) 90
 - Replacing bulbs (bed/berth) 98
 - Replacing bulbs (driver's/co-driver's) 98
 - Switching on/off (berth) 90
 - Switching on/off (driver's/co-driver's) 90
 - Switching on/off (front passenger) 90
- Reading out the driver card**
 - see FleetBoard
- Rear axle**
 - Setting the oil grade (on-board computer) 151
- Rear axle ratio** 417
- Rear foglamp**
 - Switching on/off 87
- Rear foglamps**
 - Replacing bulbs 97
- Rear lamp**
 - Protective grid 97
- Rear lamp cluster**
 - Changing a bulb 97
- Rear lamps**
 - Replacing bulbs 97
- Rechargeable battery**
 - Replacing (multifunction key) 65
- Red display message**
 - BlueTec® exhaust gas aftertreatment 176
 - Brakes and driving systems 182
 - Compressed-air system 177
 - Engine and cooling 178
 - Semitrailer 180
 - Transmission and clutch 179
 - Tyres 186
- Red event window**
 - Notes 176
- Reducing agent**
 - see AdBlue®
- Reflective safety vest** 370
- Refrigerant (air-conditioning system)**
 - Important safety notes 421
- Refuelling**
 - Filling order 317
 - Fuels 315
- Regeneration**
 - see Diesel particle filter
- Regeneration disabled**
 - Grey display message 153
- Remote control**
 - Unlocking/locking doors 61
- Remote Online**
 - Connecting/disconnecting mobile device (on-board computer) 142
 - Function 112
 - Truck-App 112
- Replace key**
 - Yellow display message 173
- Replacement key** 57
- Replacing bulbs**
 - Brake lamps 97
 - Daytime driving lights 95
 - Dipped-beam headlamps (halo-gen headlamps) 94
 - Headlamps 93

- Interior lighting 98
 - Licence plate lamp 97
 - Main-beam headlights 95
 - Navigation lights 94
 - Perimeter/side marker lamps 97
 - Rear foglamps 97
 - Rear lamps 97
 - Reversing lamp 97
 - Side marker lamp 99
 - Working-area lamp (lower) 99
 - Working-area lamp (upper) 99
 - Replacing the tyres** 404
 - Replacing wiper blades with pipe jets** 359
 - Reserve level**
 - AdBlue® 129
 - Fuel 129
 - Reservoir pressure**
 - Checking (on-board computer) 148
 - Residual engine heat utilisation**
 - Switching on/off 122
 - Rest period**
 - Checking (on-board computer) 137
 - Restraint system**
 - Introduction 49
 - Warning lamp (function) 49
 - Retarder: oil temperature too high**
 - Yellow display message 164
 - Rev counter** 128
 - Reverse gear lock** 314
 - Reverse warning device** 314
 - Reversing camera**
 - Displaying camera image (on-board computer) 140
 - Setting the video popup function ... 151
 - Reversing lamp**
 - Replacing bulbs 97
 - Road and operating safety** 402
 - Road paver operation**
 - Level control 298
 - Rocking free**
 - Activating/deactivating (on-board computer) 151
 - Automatic transmission 264
 - Drive functions 258
 - Rocking-free**
 - Activating/deactivating (button) 258
 - Roller sunblind** 71
 - Roof position marker lamps**
 - Switching on/off 91
 - Rotating beacon** 91
 - Route**
 - Creating 211
 - Route guidance**
 - Cancel 227
 - Displaying 227
 - Displaying (on-board computer) 139
 - General information 226
 - Starting 227
- S**
- SAE classification (engine oils)** 419
 - Safety**
 - Children in the vehicle 54
 - Operating safety 29
 - Safety inspection**
 - Compressed-air drier 241
 - Supply pressure in the compressed-air brake system 241
 - Supply pressure in the transmission/clutch circuit 241
 - Vehicle height 242
 - Safety net** 79
 - Screen**
 - Gesture control 208, 231
 - Using the screen 208, 231
 - Seat**
 - Air-conditioned suspension seat 74
 - In SoloStar Concept 81
 - Standard suspension seat 74
 - Static seat 74
 - Seat belt**
 - Correct usage 51
 - Seat belts**
 - Cleaning 349
 - Fastening 51
 - Important safety guidelines 50
 - Introduction 50
 - Releasing 52
 - Warning lamp (function) 52
 - Seat/berth combination**
 - In the L cab 79
 - Seats**
 - Centre seat 74

- Cleaning the cover 349
- Correct driver's seat position 73
- Function seat 76
- Important safety notes 73
- Luxury suspension seat 74
- Selecting a menu item**
 - Operating the touchscreen 231
- Selecting an audio source** 223
- Selecting stations**
 - Entering the frequency manually ... 234
 - Using station search 234
- Semi-trailer hydraulic system**
 - Care 329
 - Changing the operating pressure ... 327
 - Controls 327
 - General notes 327
 - Hydraulic connections 328
 - Hydraulic fluid level 329
 - Important safety notes 326
 - Maintenance 329
 - Operating data 330
 - Tipping 328
- Semitrailer**
 - Articulation angle 320
 - Connecting/disconnecting
compressed-air lines 324
 - Coupling 321
 - Detaching 324
 - Displaying data (on-board com-
puter) 147
 - Driving tips 320
 - Information on semitrailer cou-
pling 322
 - Information on tractor/trailer syn-
chronisation 321
 - Notes 322
 - Swivel angle 321
- Semitrailer coupling**
 - separate operating instructions 319
- Semitrailer coupling is open**
 - Red display message 180
- Semitrailer coupling sensor faulty**
 - Red display message 180
- Sensor-monitored semitrailer cou-
pling**
 - Operation/notes 322
- Service**
 - see Maintenance system (WS)
- Service brake** 244
- Service products**
 - AdBlue® 425
 - Coolant 420
 - Diesel fuel 422
 - Engine oil 419
 - FAME fatty acid methyl ester fuel .. 424
 - For drive axles and transmissions .. 420
 - Fuel additives 424
 - General notes 418
 - Hydraulic fluid 330
 - Refrigerant (air-conditioning sys-
tem) 421
 - Settings (on-board computer) 150
 - Transmission oil 420
- Setting a speed limit**
 - see Limiter
- Setting the speed**
 - see Cruise control
- Setting the volume**
 - Telephone calls 141
- Setting vehicle height**
 - Level control 295
- Side marker lamp**
 - Changing a bulb (rear lamp clus-
ter) 97
 - Replacing bulbs (side turn signal
lamp) 96
- Side marker light**
 - Replacing bulbs (side marker
lamps) 99
- Side panelling** 336
- Side windows**
 - Important safety notes 67
 - Opening/closing 67
 - Resetting 68
- Sideguard Assist** 292
- Sideguard Assist sensors**
 - Cleaning 353
- Single tyres (tyre pressure)** 406
- Sliding sunroof**
 - Closing manually 69
 - Opening/closing 68
 - Protective grid 69
 - Resetting 70
 - Roller blinds 69

- Smoke detector**
 - Function test 106
 - General information 106
 - Replacing the battery 107
 - Temporarily deactivating 106
- Snow chains**
 - Checking the tyre clearance 337
 - General notes 337
- Sockets** 104
- SoloStar Concept** 81
- Spare bulbs** 370
- Spare key** 57
- Spare wheel tyre pressure sensor battery low**
 - Grey display message 156
- Specialist workshop** 31
- Speed**
 - Display (on-board computer) 138
- Speed limitation**
 - Maximum speed 313
- Speed limiter**
 - Activating 275
 - Activating while driving 275
 - Driving 276
 - Functions and conditions for activation 275
 - Important safety notes 275
 - Overtaking 276
 - Overview 275
 - Selecting 275
 - Setting limit speed 275
- Speed setting**
 - Power take-off 345
- Spring-loaded parking brake**
 - Applying and releasing 247
 - Arrangement of the brake cylinders 400
 - Checking 247
 - Lever positions 247
 - Moving the brake cylinder to the driving position 401
 - Releasing the brake cylinder 400
 - Technical data 428
- Stability Control Assist**
 - Deactivating/activating 267
 - Function and notes 267
- Start/Stop button** 237
- Starting**
 - see Starting (engine)
- Starting (engine)** 240
- Starting-off aid**
 - Operation 300
- Starting-off aid active**
 - Yellow display message 166
- Stations**
 - Setting manually 234
 - Storing manually 235
- Steering characteristics changed**
 - Yellow display message 167
- Steering characteristics of additional axle changed**
 - Red display message 182
- Steering wheel adjustment** 84
- Steering wheel buttons**
 - see On-board computer
- Stickers**
 - General safety notes 28
- Stopping and switching off the engine** 243
- Stowage compartments**
 - see Stowage spaces and compartments
- Stowage compartments or trays**
 - Above the windscreen 107
 - At the driver's workstation 108
- Stowage spaces and compartments**
 - Coolbox 109
 - Important safety notes 107
 - Under the berth 108
 - Waste container 108
 - With exterior flaps 109
- Sun screen**
 - Sliding sunroof 69
- Supply pressure**
 - Checking in the compressed-air brake system 241
 - Checking in the transmission/clutch circuit 241
- Surround lighting (on-board computer)** 149
- Switch units**
 - Berth 46
 - Co-driver's door 46
 - Combination switch 48
 - Driver's door 45

- Driver's workstation 43
 - Multifunction lever 48
 - Multifunction steering wheel 47
 - Switch units above the wind-screen 45
 - Swivel angle** 321
 - Symbols**
 - Radio/navigation 218
- T**
- Technical data**
 - Brake system 426
 - Compressed-air reservoir 428
 - Compressed-air system 426
 - Engine 426
 - Engine data plate 418
 - Level control 428
 - Maximum permissible tyre pressure 427
 - Operating temperature (coolant temperature) 427
 - Permissible difference in tyre pressure 427
 - Spring-loaded parking brake 428
 - Tightening torques for wheel nuts .. 428
 - Tyre pressure table (single tyres) ... 406
 - Tyre pressure table (twin tyres) 411
 - Vehicle identification plate/axle loads 417
 - Telediagnosis** 369
 - Telephone**
 - Adjusting the volume for calls 141
 - Emergency call 112 234
 - Operating (on-board computer) 141
 - Overview 234
 - Telephone menu overview 234
 - Telephone menu**
 - Dialling a number 234
 - Temperature**
 - Outside temperature display 130
 - Setting (automatic climate control) 120
 - Setting (heating/air conditioning) 120
 - Tightening torques**
 - Spring-loaded parking brake cylinder release screw 428
 - Wheel nuts 428
 - Tilting system**
 - Electrohydraulic cab tilting system 374
 - Mechanical-hydraulic cab tilting system 373
 - Notes on tilting 372
 - Problems in tilting the cab 375
 - Time**
 - In the display 130
 - Tipper operation**
 - After tipping 346
 - Before tipping 345
 - Controls 346
 - On-board computer 347
 - Rear wall claw-type lock 347
 - Switching 347
 - Tipper control 347
 - Tipping 346
 - Tool kit compartment**
 - Vehicle tool kit and emergency equipment 369
 - Topping up**
 - AdBlue® 318
 - Topping up washer fluid** 357
 - Total distance recorder** 130
 - Tow-starting and towing away**
 - Coupling jaw 398
 - Towing away**
 - see Tow-starting and towing away
 - Towing eye** 399
 - Towing/tow-starting**
 - Front towing eyes 399
 - Important safety notes 397
 - Rear towing coupling 399
 - Tractor/trailer combination**
 - Notes 323
 - Trailer**
 - Articulation angle 320
 - Connecting/disconnecting compressed-air lines 324
 - Coupling up 321
 - Decoupling 324
 - Displaying data (on-board computer) 147
 - Driving tips 320

- Information on tractor/trailer synchronisation 321
- Swivel angle 321
- Trailer tow hitch**
 - see Separate operating instructions
- Trailer/semitrailer**
 - Notes about trailer/semitrailer coupling 319
- Trailers/semi-trailers**
 - Semi-trailer hydraulic system 326
- Trailing axle** 300
- Transfer case** 270
- Transmission**
 - Setting the oil grade (on-board computer) 151
- Transmission faulty**
 - Red display message 179
 - Yellow display message 164
- Transmission mode selection**
 - Mercedes PowerShift 256
- Transmission oil**
 - Checking oil level (automatic transmission) 360
 - General notes 420
 - Quality 420
- Transmission shift system**
 - Activating backup drive mode (on-board computer) 140
 - Activating/deactivating crawler mode (button) 257
 - Activating/deactivating crawler mode (on-board computer) 151
 - Activating/deactivating EcoRoll mode (on-board computer) 151
 - Activating/deactivating Hydro-move 151
 - Activating/deactivating PPC (on-board computer) 151
 - Automatic transmission 262
 - Manual transmission 251
 - Mercedes PowerShift 253
- Transmission: oil temperature too high**
 - Yellow display message 164
- Transmission/clutch circuit**
 - Checking the supply pressure 241
- Transmission/clutch reserve pressure too low**
 - Yellow display message 162
- Trip computer**
 - Calling up/resetting (on-board computer) 137
- Trip data (on-board computer)** 137
- Trip meter** 130
- Truck-App**
 - Connecting/disconnecting mobile devices (on-board computer) 142
 - General notes 112
- Turbo retarder clutch**
 - see Hydrodynamic clutch
- Turn signal**
 - Replacing bulbs (side turn signal lamp) 96
- Turn signal faulty**
 - Yellow display message 166
- Turn signal lamp**
 - Replacing bulbs (headlamp) 96
- Turn signals**
 - Changing a bulb (rear lamp cluster) 97
 - Replacing bulbs 96
 - Switching on/off 88
- Twin tyres (tyre pressure)** 411
- Type identification plate**
 - see Vehicle identification plate
- Tyre inflator hose** 370
- Tyre pressure**
 - Determining 405
 - Displaying 145
 - Important safety notes 404
 - Maximum permissible air pressure 427
 - Monitoring (on-board computer) 144
 - Permissible difference in pressure 427
 - Pressure loss warning 145
 - Table (single tyres) 406
 - Table (twin tyres) 411
- Tyre pressure checker** 370
- Tyre pressure in spare wheel too low**
 - Grey display message 156

- Tyre pressure monitor faulty**
 Yellow display message 175
- Tyre pressure monitor in spare wheel faulty**
 Grey display message 156
- Tyre pressure monitor inoperative**
 Yellow display message 175
- Tyre pressure sensor battery low**
 Yellow display message 175
- Tyre pressure sensor faulty**
 Yellow display message 175
- Tyre pressure too high**
 Yellow display message 175
- Tyre pressure too low**
 Red display message 186
 Yellow display message 175
- Tyre temperature too high**
 Yellow display message 175
- Tyres**
 Changing tyres 404
 Condition 403
 Damage 403
 Load-bearing capacity 403
 Minimum tyre tread depth 402
 Notes on wheels with a tyre pressure sensor 404
 Operating and road safety 402
 Regular checking 402
 Retreaded 404
 Service life 403
 Types 403
 Tyre speed rating 403
- U**
- Underride guard (collapsible)** 303
- Unit of measurement**
 Setting (on-board computer) 149
- Units**
 Setting (on-board computer) 149
- V**
- Vehicle**
 Cleaning 348
 Data acquisition 33
 Equipment 28
 Forced lowering 298
 Implied warranty 28
 Loading/unloading when the ignition is switched off (level control) .. 298
 Locking/unlocking the doors 60
 Operating safety 29
 Parking up 368
 Pulling away 242
 Registration 31
 Stopping and parking 243
 Tow-starting and towing away 397
 Vehicle identification plate 417
- Vehicle assemblies**
 Checking for leaks 362
- Vehicle bodies** 32
- Vehicle identification number**
 see VIN
- Vehicle identification plate** 417
- Vehicle tool kit and emergency equipment**
 Important safety notes 369
- VIN** 417
- Voltage transformer** 105
- Volume**
 Adjusting 207
- W**
- Warning and indicator lamps**
 On-board computer 187
- Warning beacon** 370
- Warning tone** 314
- Warning triangle** 370
- Warning/indicator lamps**
 Engine diagnostics 130
 Engine diagnostics (BlueTec®5 vehicles) 131
 Engine diagnostics (BlueTec®6 vehicles) 131
 Instrument cluster 41
- Warnings**
 Stickers 28
- Washer fluid level**
 Grey display message 157
- Waste container** 108
- Weight**
 Maximum permissible gross vehicle weight 266
 Weight distribution 266

Wheel brake overloaded	
Yellow display message	166
Wheel chock	372
Wheel loads	266
Wheel nuts	
For light-alloy disc wheels	385
For pressed-steel wheels	385
Retightening	386
Tightening torques	428
Wind deflector	
Adjusting	331
Diagrams	332
Windows	
see Side windows	
Windscreen heating	102
Windscreen washer system	
Notes on winter driving	102
Operation	102
Topping up fluid	357
Windscreen wipers	
Replacing the wiper blades	359
Switching on/off	101
Winter diesel	423
Winter driving	
General notes	336
Winter tyres	336
see Winter operation	
Winter operation	
Checking tyre clearance	337
Notes on snow chains	337
Radiator cover	32
Snow chains	337
Winter tyres	336
Working speed	
Preselecting	342
Working-area lamp (lower)	
Replacing bulbs	99
Working-area lamp (upper)	
Replacing bulbs	99
Wrench for cab tilting pump	371

X

Xenon headlamps	
Notes on replacing bulbs	91

Y

Yellow display message

BlueTec®5 exhaust gas aftertreatment	158
BlueTec®6 exhaust gas aftertreatment	158
Brakes and driving systems	167
Compressed-air system, engine and cooling	162
Diesel particle filter	158
Lighting system, electrical system and key	173
Service products and maintenance	161
Trailer/semitrailer	166
Transmission and clutch	164
Tyres	175
Yellow event window	
Notes	158

Operating Instructions

Before the first journey

These Operating Instructions, the Maintenance or Service booklet and the equipment-dependent Supplements are integral parts of the vehicle. Keep these documents in the vehicle at all times. If you sell the vehicle, always pass all documents on to the new owner.

Before your first journey, read these documents carefully and familiarise yourself with your vehicle.

For your own safety and a longer vehicle life, always follow the instructions and warning notes in these Operating Instructions. Disregarding them may lead to damage to the vehicle or personal injury.

Implied warranty

! Observe the notes in this Owner's Manual regarding the correct operation of your vehicle and possible damage to the vehicle. Damage to the vehicle which is caused by violation of these notes is not covered by the Mercedes-Benz implied warranty or the new or used-vehicle warranty.

Vehicle equipment

These Operating Instructions describe all the models and standard and optional equipment of your vehicle that were available at the time of going to print. Country-specific deviations are possible. Bear in mind that your vehicle may not be equipped with all the functions described. This also applies to safety-relevant systems and functions. The equipment in your vehicle may therefore differ from that shown in the descriptions and illustrations.

All systems found in your vehicle are listed in your vehicle's original purchase agreement. Contact a Mercedes-Benz Service Centre if you have any questions about equipment or operation.

Digital and printed Operating Instructions

If your vehicle is equipped with the radio/navigation system, the radio/navigation system provides you with the Digital Operating Instructions (▷ page 228).

There is no electronic update of the Digital Operating Instructions. Amendments are only made to the printed Operating Instructions.

The printed Operating Instructions (including any Supplements) must be observed.

Correct use

Observe the following information when operating the vehicle:

- the safety notes in these Operating Instructions
- the technical data in these Operating Instructions
- traffic regulation and laws
- laws pertaining to motor vehicles and safety standards

There are various warning stickers affixed to the vehicle. If you remove warning stickers, you and others may fail to recognise the dangers. Leave the warning stickers in their original position.

WARNING

Modifications to electronic components, their software as well as wiring could affect their function and/or the operation of other networked components. This could in particular also be the case for systems relevant to safety. They might not function properly anymore and/or jeopardise the operational safety of the vehicle. There is an increased risk of an accident and injury.

Do not attempt to modify the wiring as well as electronic components or their software.

Always have work on electrical and electronic components carried out at a qualified specialist workshop.

The general operating permit for your vehicle could be rendered invalid if you carry out changes to electronic components, their software as well as wiring.

WARNING

Gases and liquids from substances that constitute a health hazard or react aggressively can escape, even from securely closed containers. If you transport these substances inside the vehicle, this may affect your health and impair your concentration while you are driving. It may also cause malfunctions or electrical component system failures. There is a risk of fire and accident.

Do not store or transport any substances in the vehicle that are hazardous to health or react aggressively.

Examples of substances that are hazardous to health and/or react aggressively:

- solvents
- fuel
- oil and grease
- cleaning agents
- acids

Protection of the environment

Economical and environmentally aware driving

Environmental note

Daimler AG has a declared policy of comprehensive environmental protection.

The objective is to use natural resources sparingly and in a manner that takes the requirements of both nature and humanity into account.

You too can help to protect the environment by operating your vehicle in an environmentally responsible manner.

Fuel consumption and the rate of engine, transmission, brake and tyre wear depend on the following factors:

- the operating conditions of your vehicle
- your personal driving style

You can influence both factors. For this reason, observe the following notes:

Operating conditions

- avoid short trips as these increase fuel consumption.
- make sure that the tyre pressures are always correct.
- do not carry any unnecessary weight.
- a regularly serviced vehicle will contribute to environmental protection. You should therefore adhere to the service intervals.
- all maintenance work should be carried out at a qualified specialist workshop.

Personal driving style

- do not depress the accelerator pedal when starting the engine.
- do not warm up the engine with the vehicle stationary.
- drive carefully and maintain a safe distance from the vehicle in front.
- avoid frequent and heavy acceleration and braking.
- change gear in good time and use each gear only up to $\frac{2}{3}$ of its maximum engine speed.
- switch off the engine when waiting in stationary traffic.
- keep an eye on the vehicle's fuel consumption.

Operating safety and vehicle registration

Notes on driving

There is a risk of damage to the vehicle if:

- the vehicle becomes stuck, e.g. on a high kerb or an unpaved road
- you drive too fast over an obstacle, e.g. a kerb, a speed bump or a pothole in the road
- a heavy object strikes the underbody or parts of the chassis

In such situations, the body, frame, underbody, chassis parts, wheels or tyres could be damaged without the damage being visible. Components damaged in this way can unexpectedly fail or, in the case of an accident, no longer withstand the strain they are designed for. If the underbody panelling is damaged, combustible materials

such as leaves, grass or twigs can gather between the underbody and the underbody panneling. If these materials come in contact with hot parts of the exhaust system for an extended period, they can catch fire.

WARNING

Flammable material such as leaves, grass or twigs may ignite if they come into contact with hot parts of the exhaust system. There is a risk of fire.

When driving off road or on unpaved roads, check the vehicle's underside regularly. In particular, remove parts of plants or other flammable materials which have become trapped. In the case of damage, contact a qualified specialist workshop.

Have the vehicle checked and repaired immediately at a qualified specialist workshop. If, on continuing your journey, you notice that driving safety is impaired, pull over and stop the vehicle immediately, paying attention to road and traffic conditions. In such cases, consult a qualified specialist workshop.

Declarations of conformity

Vehicle components which receive and/or transmit radio waves

The following note refers to all components of the vehicle which receive and/or transmit radio waves and the integrated information systems and communications equipment in the vehicle:

The components of the vehicle that receive and/or transmit radio waves are compliant with the basic requirements and all other relevant regulations stipulated by Directive 2014/53/EU.

Electromagnetic compatibility

The electromagnetic compatibility of the vehicle components has been checked and certified according to the currently valid version of Directive ECE-R 10.

Jack

Transcript and translation of the original declaration of conformity:

EC Declaration of conformity 2006/42/EC
WEBER-HYDRAULIK GMBH, Heilbronner Str. 30, 74363 Güglingen, Germany, declares that the product "Weber hydraulic jack" models:
A AD ADX AH AHX AL AT ATD ATDX ATG ATN ATGX ATPX ATQ AX

Load: 2,000 to 100,000 kg

Serial no.: from construction year 01/2010
comply with the relevant fundamental regulations of the EC machinery directive for safety and health.

This EC declaration of conformity shall become void:

- if modifications are made or repairs are carried out by unqualified persons
- if the products are not employed in accordance with the application specified in the Operating Instructions
- if the mandatory regular inspections are not carried out

Relevant EC Directives: Machinery guideline mark 2006/42/EC

Applicable norms: ISO 11530

Quality assurance: DIN EN ISO 9001:2000

Güglingen, 1 July 2013

Signed by:

Managing Director, WEBER-HYDRAULIK GmbH
Authorised technical documentation representative, WEBER-HYDRAULIK GmbH
Heilbronner Straße 30, 74363 Güglingen, Germany

Diagnostics connection

The diagnostics connection is used for connecting diagnostic equipment at a qualified specialist workshop.

WARNING

If you connect equipment to a diagnostics connection in the vehicle, it may affect the operation of vehicle systems. As a result, the operating safety of the vehicle could be affected. There is a risk of an accident.

Only connect equipment to a diagnostics connection in the vehicle, which is approved for your vehicle by Mercedes-Benz.

Modifying the engine output

! Increased power could:

- change emission levels
- cause malfunctions
- lead to consequential damage

The operating safety of the engine cannot be guaranteed in all situations.

Any tampering with the engine management system in order to increase the engine power output will lead to the loss of warranty entitlements.

If the vehicle's engine power output is increased:

- tyres, suspension, brake and engine cooling systems must be adapted to the increased engine power output
- have the vehicle recertified
- report changes in power output to the vehicle insurers

This will otherwise lead to the invalidation of the vehicle's general operating permit and its insurance cover.

If you sell the vehicle, inform the buyer of any alterations to the vehicle's engine power output. If you do not inform the buyer, this may constitute a punishable offence under national legislation.

Qualified specialist workshop

A qualified specialist workshop has the necessary specialist knowledge, tools and qualifications to carry out the work required on the vehicle correctly.

This is particularly applicable to work relevant to safety. Observe the notes in the Maintenance or Service booklet.

You should always have the following work on your vehicle carried out at a qualified specialist workshop:

- safety-relevant work
- service and maintenance work
- repair work

- modifications as well as installations and conversions
- work on electronic components

Mercedes-Benz recommends that you use a Mercedes-Benz Service Centre.

! Only have work carried out on the engine electronics and its associated parts, such as control units, sensors, actuating components and connector leads, at a qualified specialist workshop. Vehicle components may otherwise wear more quickly and the vehicle's operating permit may be invalidated.

Vehicle registration

Mercedes-Benz may ask its Service Centres to carry out technical inspections on certain vehicles. This is always the case if it is possible to improve quality or safety levels. Mercedes-Benz can only inform you about vehicle checks if it has your registration data.

Your registration data are not available if:

- your vehicle was not purchased at an authorised specialist dealer
- your vehicle has not yet been inspected at a Mercedes-Benz Service Centre

It is advisable to register your vehicle with a Mercedes-Benz Service Centre. Inform Mercedes-Benz as soon as possible about any change in address or vehicle ownership.

BlueTec® exhaust gas aftertreatment

The BlueTec® exhaust gas aftertreatment system must be operated in conjunction with the reducing agent AdBlue® if it is to function correctly.

Information about AdBlue® can be found in the Service products section (> page 425).

Topping up and operating the vehicle with AdBlue® is required for compliance with emissions requirements and is, therefore, a condition of the operating permit for the vehicle. The operating permit is invalidated if the vehicle is operated without AdBlue®. The legal consequence of this is that the vehicle may no longer be operated on public roads.

This may be an offence or a breach of road traffic regulations in certain countries. Special concessions granted either at the time of purchase



or to reduce operating costs, e.g. reduced taxes or tolls, may also be rendered invalid retroactively. This may be the case in the country of registration as well as the country of operation.

Engine management monitors the BlueTec® exhaust gas aftertreatment systems for compliance with emissions laws and regulations.

Among other topics, the on-board computer informs you of:

- the status of the BlueTec® exhaust gas aftertreatment (▷ page 130)
- the level of AdBlue® (▷ page 129)
- the degree of saturation of the diesel particle filter (▷ page 311)

If you attempt to operate the vehicle without AdBlue®, with diluted AdBlue® or with a different reducing agent, this will be detected by the engine management system. Other emissions-relevant malfunctions, e.g. dosage malfunctions or sensor errors, are also detected and logged.

The  indicator lamp displays emissions-relevant faults after the engine is started. On BlueTec®6 vehicles, the  indicator lamp also signals the status of the BlueTec® exhaust gas aftertreatment for a quick on-site check by the authorities.

The  indicator lamp warns you if the diesel particle filter reaches a critical degree of loading and indicates a malfunction.

The on-board computer warns you in good time about emissions-relevant malfunctions or faulty operation and displays, according to priority:

- grey event windows (▷ page 153)
- yellow event windows (▷ page 158)
- red event windows (▷ page 176)

On BlueTec®6 vehicles, the on-board computer also shows the  indicator lamp in the status area of the display for the duration of the malfunction detected.

If you do not observe these event windows and their instructions, it is possible that:

- engine power output will be reduced
- speed is limited to approximately 20 km/h on BlueTec®6 vehicles
- the diesel particle filter will have to be replaced earlier than intended

If there is a malfunction with the BlueTec® exhaust gas aftertreatment system, have it checked and repaired at a qualified specialist workshop.

Attachments, bodies, equipment and conversions

Notes on body/equipment mounting directives

I For safety reasons, have bodies manufactured and fitted in accordance with the applicable Mercedes-Benz body/equipment mounting directives. These body/equipment mounting directives ensure that the chassis and the body form one unit and that maximum operating and road safety is achieved.

For safety reasons, Mercedes-Benz recommends that:

- no other modifications should be made to the vehicle.
- approval should be obtained from Mercedes-Benz in the event of deviations from approved body/equipment mounting directives.

Approval from certified inspection agencies or official approvals cannot rule out risks to your safety.

Technical changes to the vehicle can affect the functionality of stability control. Observe the notes in the body/equipment mounting directives.

Observe the information on genuine Mercedes-Benz parts (▷ page 33).

The Mercedes-Benz body/equipment mounting directives can be found on the Internet at <http://bb-portal.mercedes-benz.com>.

There you can also find information on pin assignment and fuse replacement.

You can obtain further information from any Mercedes-Benz Service Centre.

Notes on the engine radiator

Even seemingly small changes to the vehicle, such as attaching a radiator trim for winter driving or as protection against insects, are not permitted. Do not cover the radiator. Do not use thermal mats, insect protection covers or anything similar.

Doing so can cause the diagnostics system to display inaccurate values. In some countries, the recording of engine diagnostics data is a legal requirement, and must always be verifiable and accurate.

Genuine Mercedes-Benz parts

Environmental note

Daimler AG also supplies reconditioned assemblies and parts which are of the same quality as new parts. For these, the same warranty applies as for new parts.

The operating safety of the vehicle could be jeopardised if you use parts, tyres and wheels that have not been approved by Mercedes-Benz. This could lead to malfunctions in safety-relevant systems, e.g. the brake system. Only use genuine Mercedes-Benz parts or parts of equal quality. Only use tyres and wheels approved for your type of vehicle.

Mercedes-Benz checks genuine Mercedes-Benz parts for:

- reliability
- safety
- suitability

Despite ongoing market research, Mercedes-Benz is unable to assess other parts. Mercedes-Benz therefore accepts no responsibility for the use of such parts in Mercedes-Benz vehicles, even if they have been independently or officially approved by a technical testing centre.

In the Federal Republic of Germany, certain parts are officially approved for installation or modification only if they comply with legal requirements. This is also valid in several other countries. All genuine Mercedes-Benz parts meet the approval requirements. The use of unapproved parts may result in the general operating permit being invalidated.

This is the case if:

- they cause a change to the vehicle type from that for which the vehicle's general operating permit was granted.
- other road users could be endangered.
- the emissions or noise levels are adversely affected.

Always specify the vehicle identification number (VIN) when ordering genuine Mercedes-Benz parts (▷ page 417).

Data stored in the vehicle

Information from electronic control units

There are electronic control units installed in your vehicle. Some of these are required for the safe functioning of your vehicle, some support you while driving (driver assistance systems). Your vehicle also offers a range of comfort or entertainment functions, which are also controlled by the electronic control units.

Electronic control units contain data memories that can temporarily or permanently store technical information about the vehicle's operating state, component loading, maintenance requirements as well as technical events and faults.

This information generally documents the condition of a component, a module, a system or the surroundings, for example:

- Operating states of system components (e.g. fill levels, battery status, tyre pressure)
- Status messages concerning the vehicle or its individual components (e.g. number of wheel revolutions/speed, deceleration in movement, lateral acceleration, display of fastened seat belts)
- Malfunctions and defects in important system components (e.g. lights, brakes)
- information concerning events that may damage the vehicle
- System responses in special driving situations (e.g. airbag deployment, intervention of stability control systems)
- Ambient conditions (e.g. temperature, rain sensor)

In addition to performing the actual control unit function, this data is used by manufacturers to detect and rectify faults and to optimise vehicle functions. Most of this data is stored in volatile memory and processed only in the vehicle itself. Only a small part of the data is stored in event or fault memories.

When you use services, the technical data from the vehicle can be read out by service network employees or third parties. Services can include repair services, maintenance processes, warranty cases and quality assurance measures. The data is read out via the connection for OBD (European on-board diagnostics) in the vehicle, which is required by law. The relevant offices in the service network or third parties collect, process and use the data. This data documents

the vehicle's technical states, is used to help in finding faults and improving quality and is sent to the manufacturer where necessary. In addition, the manufacturer is subject to product liability. The manufacturer needs technical data from vehicles for this purpose.

Fault memories in the vehicle can be reset by a service outlet during repair or service work.

Depending on the selected equipment, you can import your own data into vehicle convenience and infotainment functions.

These include, for example:

- multimedia data such as music, films or photos for playback in an integrated multimedia system
- address book data for use in conjunction with an integrated hands-free system or an integrated navigation system
- navigation destinations that have been entered
- data about using Internet services

This data can be saved locally in the vehicle or is located on a device that you have connected to the vehicle. If this data is saved in the vehicle, you can delete it at any time. This data is sent to third parties only at your request, particularly when you use online services in accordance with the settings that you have selected.

You can save convenience settings/personalised settings in the vehicle and modify them at any time.

Depending on the piece of equipment in question, these can include:

- settings for the seat and steering wheel positions
- suspension and climate control settings
- customisations such as interior lighting

If your vehicle is equipped appropriately, you can connect your smartphone or another mobile terminal to the vehicle. You can control this by means of the control elements integrated in the vehicle. The smartphone's picture and sound can be output via the multimedia system. Specific items of information are also sent to your smartphone.

Depending on the type of integration, this can include:

- general vehicle status
- position data

This allows the use of selected smartphone apps, such as navigation or music player apps.

There is no additional interaction between the smartphone and the vehicle, particularly active access to vehicle data. The type of additional data processing is determined by the provider of the app being used. Whether you can configure settings for it and, if so, which ones, depends on the app and your smartphone's operating system.

Service provider

Wireless network connection

If your vehicle has a wireless network connection, data can be exchanged between your vehicle and other systems. The wireless network connection is made possible by the vehicle's own transmitter and receiver or by mobile end devices that you have brought into the vehicle (e.g. smartphones). This wireless network connection enables online functions to be used. These include online services and applications/ Apps provided by the manufacturer or other providers.

Services provided by the manufacturer

In the case of online services provided by the manufacturer, the manufacturer describes the respective functions in an appropriate place together with the associated legal data protection information. Personal data can be used in order to provide online services. The data exchange for this takes place via a secure connection, e.g. with the manufacturer's IT systems intended for the purpose. The collection, processing and use of personal data that goes beyond the provision of services will only take place on the basis of a legal permit or consent.

You can usually activate and deactivate the services and functions (some of which are subject to a fee). In some cases, this also applies to the vehicle's entire data connection. This does not include legally prescribed functions and services such as the "E-Call" emergency call system.

Services from third parties

If it is possible to use online services from other providers, these services are the responsibility of the provider in question and subject to that provider's data protection conditions and terms of use. The manufacturer has no influence over the data exchanged in such cases.

For this reason, please ask the service provider for information about the type, extent and purpose of the collection and use of personal data when services are provided by third parties.

Cockpit

Overview, left-hand-drive vehicle

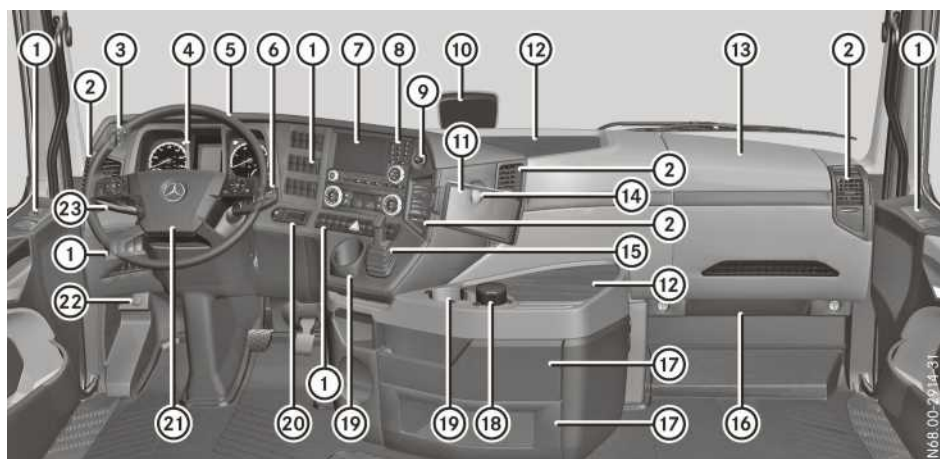

	Function	Page
①	Switch units	43
②	Air vents	120
③	Light switch	86
④	Instrument cluster	40
⑤	Multifunction steering wheel	84
⑥	Multifunction lever	48
⑦	Climate control panel	116
⑧	Radio and/or navigation device	216
⑨	Cigarette lighter 24 V socket	106 104
⑩	Lane Keeping/ATTENTION ASSIST camera and rain/light sensor	352
⑪	DispoPilot	206
⑫	Stowage spaces Climbing aids	107 77

	Function	Page
⑬	Folding table	
⑭	24 V socket	104
⑮	Parking brake	247
⑯	Main fuse carrier covering	387
⑰	Trays	108
⑱	Ashtray	105
⑲	Cup holder	111
⑳	Ignition lock on the dashboard (example)	237
㉑	Horn (air horn)	
㉒	Adjusts the multifunction steering wheel	84
㉓	Combination switch	48

Overview, right-hand-drive vehicle

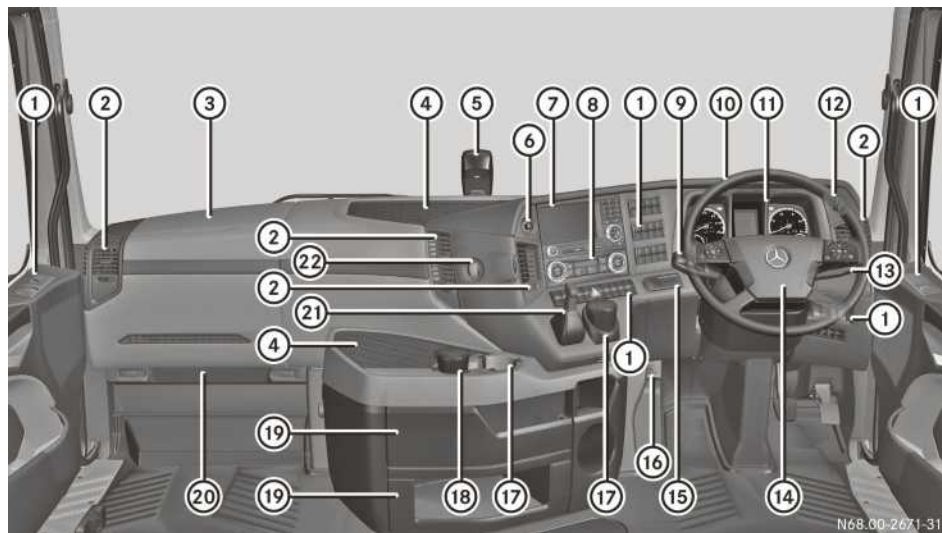

N68.00-2671-31

	Function	Page		Function	Page
①	Switch units	43	⑪	Instrument cluster	41
②	Air vents	120	⑫	Light switch	86
③	Folding table		⑬	Multifunction lever	48
④	Stowage spaces Climbing aids	107 77	⑭	Horn (air horn)	
⑤	Lane Keeping/ATTENTION ASSIST camera and rain/ light sensor	352	⑮	Ignition lock on the dash- board (example)	237
⑥	Cigarette lighter 24 V socket	106 104	⑯	Adjusts the multifunction steering wheel	84
⑦	Radio and/or navigation; see separate operating instruc- tions		⑰	Cup holder	111
⑧	Climate control panel	116	⑱	Ashtray	105
⑨	Combination switch	40	⑲	Trays	108
⑩	Multifunction steering wheel	84	⑳	Main fuse carrier covering	387
			㉑	Parking brake	247
			㉒	24 V socket	104

Overhead control panel

Overview, left-hand-drive vehicle

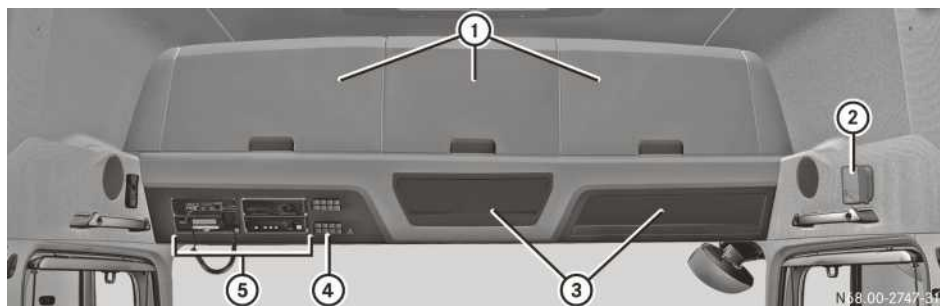

	Function	Page
①	Stowage compartments	107
②	Smoke detector	106
③	Stowage spaces	107
④	Switch units	45
⑤	DIN slot for:	

	Function	Page
	Two-way radio, see the separate operating instructions	
	Digital tachograph, see the separate operating instructions	
	FleetBoard®	190

Overview, right-hand-drive vehicle

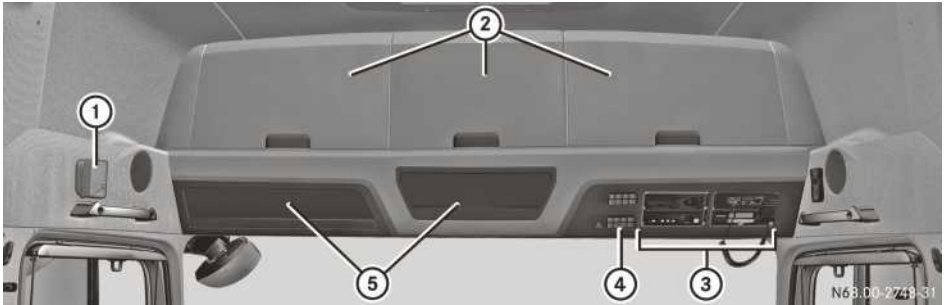

	Function	Page
①	Smoke detector	106
②	Stowage compartments	107
③	DIN slot for: Radio, see the separate operating instructions Two-way radio, see the separate operating instructions	

	Function	Page
	Digital tachograph, see the separate operating instructions FleetBoard®	190
④	Switch units	45
⑤	Stowage spaces	107

Instrument cluster

Displays

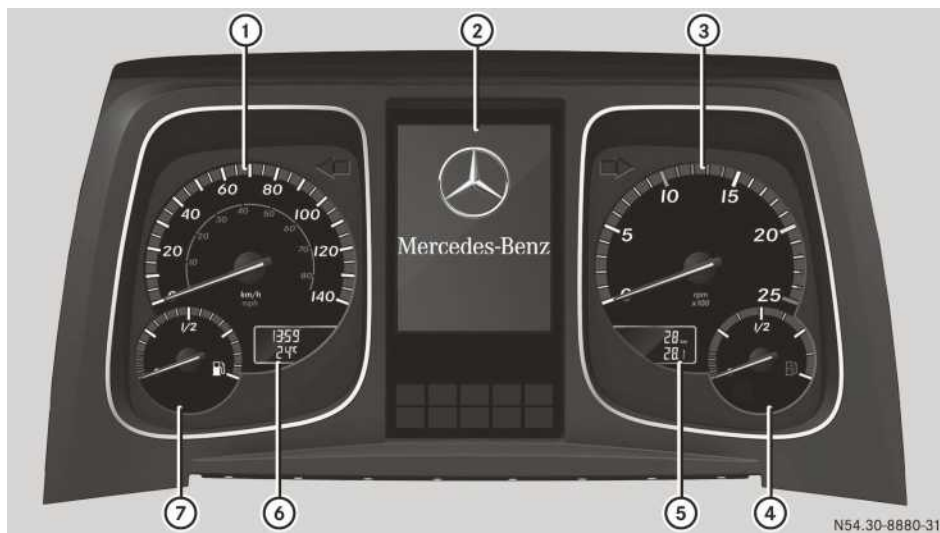

N54.30-8880-31

Example: instrument cluster

	Function	Page
①	Speedometer	
②	On-board computer	133
③	Rev counter	128
④	AdBlue® level (Vehicles with BlueTec® exhaust gas after treatment) Reservoir pressure of brake circuits (vehicles without BlueTec® exhaust gas after treatment)	129

	Function	Page
⑤	Total distance and trip distance	130
⑥	Clock and outside temperature display	130
⑦	Fuel level	129

i On vehicles without display ⑤ and ⑥, scroll in the on-board computer to the **Truck info** menu window in the four data menu

(▷ page 137). The menu window displays the total distance recorder, trip meter, time and outside temperature.

Indicator lamps



N54.30-8891-31

Example: instrument cluster

	Function	Page		Function	Page
①	Warning and indicator lamps in the speedometer			ASR (acceleration skid control system)	266
	Engine diagnostics	130		ABS (Anti-lock Braking System)	245
	Cab tilt lock	372		Brake malfunction	241
	Level control outside driving level	295	④	Warning and indicator lamps in the AdBlue® display	
	Electric power steering	167		Diesel particle filter, automatic regeneration	311
	Differential lock	268		Diesel particle filter malfunction	311
	Instruction to brake at high engine speeds	128	⑤	Warning and indicator lamps below the on-board computer	
②	Turn signals	88		Main-beam headlamps	88
③	Warning and indicator lamps in the rev counter			Continuous brake	250
	Hill holder	249		(red) Parking brake	247
	Frequent-stop brake	248		(yellow) Trailing axle	300
	Active Brake Assist	284			
	Stability Control Assist deactivated	267			
	Stability Control Assist	267			

	Function	Page
	Side lamps	86

i An overview of the warning and indicator lamps in the status area of the on-board com-

	Function	Page
	Hydrodynamic clutch	264

puter can be found under "On-board computer and displays" (▷ page 187).







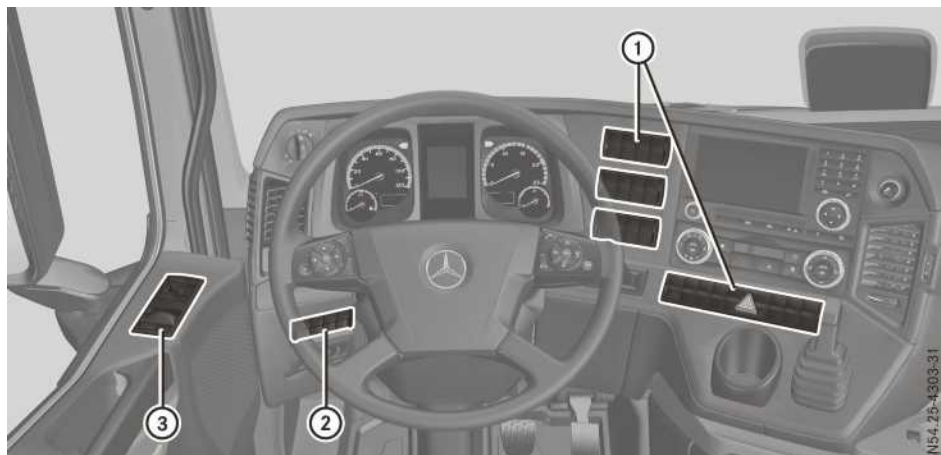



Switch units







Cockpit

Driver's workstation



	Function	Page		Function	Page
①	Switch panel			Coolbox	
	FleetBoard with driver card: Service Call			Battery isolator switch	102
	Active Brake Assist	284		Anti-lock braking system	245
	Lane Keeping Assist	290		Rotation chains (see the separate Operating Instructions)	
	Level control: driving level	298		Diesel particle filter: starts regeneration	312
	Level control: raised driving level	299		Diesel particle filter: blocks regeneration	312
	Level control: STOP	297		Hill holder	249
	Level control: shunting level	299		Frequent-stop brake	248
	Level control: road paver operation	298		Off-road gear transfer case	270
	Constant engine speed	345		Rocking-free	258
	Power take-off	341		Crawler mode	257
	12 V voltage transformer	105		Manoeuvring mode	265
	Electrohydraulic cab tilting unit	374		ASR (acceleration skid control system)	266
	ATA	62		Stability Control Assist	267
	Panic alarm	64		Hazard warning lamps	

	Function	Page
	Differential locks	268
	Leading/trailing axle	300
	Starting-off aid	300
	Steerable additional axle	301
	Reverse warning device	314
	Rotating beacon	91
	Perimeter lamp	91
	Hydraulic additional drive system	271
	Windscreen heating	102
	Switch panel	

	Function	Page
	Loading tailgate (see the separate Operating Instructions)	
	Working-area lamp (switches off automatically after pulling away)	
	Level control: raises the chassis frame	297
	Level control: lowers the chassis frame	297
	Auxiliary headlamps	
	12 V voltage transformer	105
	Driver's door switch panel	45

Above the windscreen



	Function	Page
	Switch panels	
	Opens the left-hand roller sunblind	71
	Closes the left-hand roller sunblind	71
	Opens the right-hand roller sunblind	71
	Closes the right-hand roller sunblind	71
	Illuminated Mercedes star	91
	Driver's reading lamp	89
	Nightlight (green)	89
	Interior lamps	89
	Automatic control of the interior lighting	89
	Ambient lighting (blue)	89
	Opens the sliding sunroof/pop-up roof	68
	Closes the sliding sunroof/pop-up roof	68

Driver's door



	Function	Page
	Switch panel	
	Exterior mirror, left	85
	Exterior mirror, right	85
	Adjusts the exterior mirrors	85
	Exterior mirror heating	86
	Manoeuvring position for the co-driver's exterior mirror	85
	Opens/closes the side windows	67
	Locks the doors	61
	Unlocks the doors	61

Co-driver's door

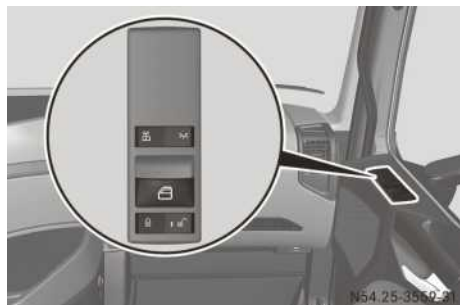

	Function	Page
	Switch panel	
	Co-driver's reading lamp	89
	Interior lamps	89
	Opens/closes co-driver's side window	67
	Locks the doors	61
	Unlocks the doors	61

Berth



	Function	Page
①	Reading lamp: bed/berth	90
②	Switch panel: bed/berth	
	Auxiliary heating	125
	Auxiliary air conditioning	123
	Audio equipment (radio)	113
	Sliding sunroof/pop-up roof	
		68
	Interior lighting	
		89

Multifunction steering wheel



Left group of buttons on the multifunction steering wheel

	Function	Page
	Operating the on-board computer:	133
	To select the next main menu/next entry in the input window, to increase or reset value	
	To select the previous main menu/previous entry in the input window or to decrease value	
	Next menu window/next menu bar down in the input window	
	Previous menu window/next menu bar up in the input window	
	To open and close input window/to acknowledge event window	
	To store/display favourite menu window	
	To increase/ decrease the volume:	
	Audio	142
	Telephone	141



Right-hand button group on the multifunction steering wheel

	Function	Page
	Operating the driving systems:	
	Selects cruise control	276
	Selecting the distance control assistant	278
	Activates and adjusts current speed/limit speed; increases the speed/limit speed	
	Activates and calls up stored speed/limit speed; reduces set speed/limit speed	
	Selects the speed limiter	275
	Deactivates speed limiter/ cruise control/distance control assistant	
	Driving systems menu window	
	Sets the speed tolerance (cruise control/distance control assistant)	277
	Sets the specified distance (distance control assist)	282
	Operating the telephone:	141
	Makes or accepts a call/displays Telephone menu window	
	Ends or rejects a call/ activates voice control	216

Combination switch and multifunction lever

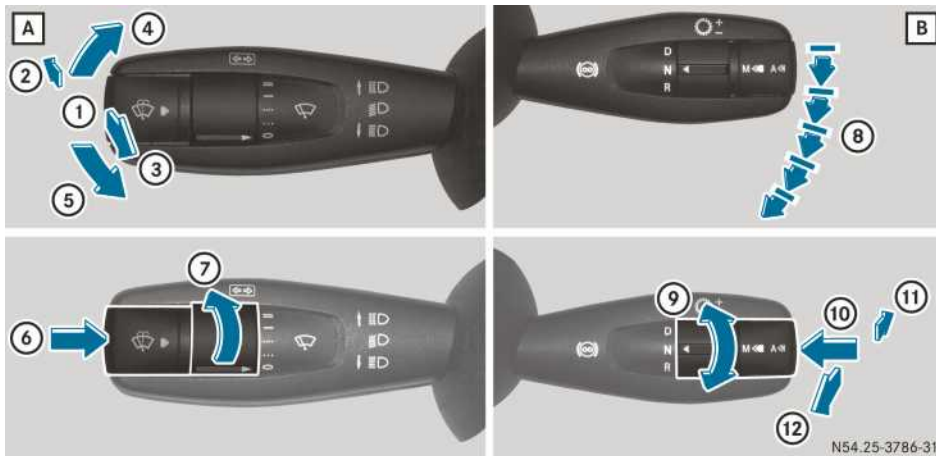

	Function	Page
A	Combination switch	
①	Main-beam headlamps off (when dipped-beam headlamps are switched on)	88
②	Main-beam headlamps on (when dipped-beam headlamps are switched on)	88
③	Headlamp flasher	88
④	Turn signal, right	88
⑤	Turn signal, left	88
⑥	Wipes with washer fluid/ single wipe	101
⑦	Windscreen wipers	101
B	Multifunction lever	
⑧	Continuous brake	250
⑨	Automatic gearshift – direction selection	
	D Drive	258
	N Neutral	259
	R Reverse	261

	Function	Page
⑩	Automatic gearshift – transmission mode selection A/M Automatic drive program A with the economy, power, fleet, offroad, heavy, municip or fire-sv or Manual drive program M	255
⑪	Automatic gearshift – shifts down manually Automatic drive program Manual drive program	259 260
⑫	Automatic gearshift – shifts up manually Automatic drive program Manual drive program	259 260

Useful information

These Operating Instructions describe all the models and standard and optional equipment of your vehicle that were available at the time of going to print. Country-specific differences are possible. Bear in mind that your vehicle may not be equipped with all the functions described. This also applies to safety-relevant systems and functions.

Read the information on qualified specialist workshops (▷ page 31).

Occupant safety

Introduction to the restraint system

The restraint system can reduce the risk of vehicle occupants coming into contact with parts of the vehicle's interior in the event of an accident. The restraint system can also reduce the forces to which vehicle occupants are subjected during an accident.

The restraint system includes the:

- seat belt system
- driver's airbag

The components of the restraint system work in conjunction with each other. They can only offer protection if all vehicle occupants always:

- have the seat belt correctly fastened (▷ page 51)
- have the seat adjusted properly (▷ page 73)

Depending on the vehicle's equipment, the head restraints must also be adjusted properly.

As the driver, you must also make sure that the steering wheel is also adjusted properly. Observe the information on the correct driver's seat position (▷ page 73).

In addition, you must make sure that the airbags can inflate properly if they are deployed (▷ page 52).

The driver's airbag supplements a correctly worn seat belt. As an additional safety device, the driver's airbag increases the level of protection for the driver in the event of an accident. The driver's airbag is not deployed, for example, in the event of an accident in which sufficient protection is offered by the seat belt. However, the seat belt and driver's airbag generally do not

protect against objects penetrating the vehicle from the outside.

Information on how the restraint system operates can be found under "Deployment of the belt tensioner and driver's airbag" (▷ page 53).

See "Children in the vehicle" for information on children travelling with you in the vehicle as well as on child restraint systems (▷ page 54).

Important safety notes

WARNING

If the restraint system is modified, it may no longer work as intended. The restraint system may then not perform its intended protective function by failing in an accident or triggering unexpectedly, for example. There is an increased risk of injury, possibly even fatal.

Never modify parts of the restraint system. Do not attempt to modify the wiring as well as electronic components or their software.

If the vehicle is adapted to a person with a physical disability, contact a qualified specialist workshop. Mercedes-Benz recommends that you use a Mercedes-Benz Service Centre.

Restraint system warning lamp

The functions of the restraint system are checked after the ignition is switched on and at regular intervals while the engine is running. Therefore, malfunctions can be detected in good time.

If the  restraint system warning lamp lights up in the status area of the on-board computer, the restraint system is malfunctioning.

WARNING

If the restraint system is malfunctioning, restraint system components may be triggered unintentionally or may not deploy as intended during an accident. This may affect the seat belt tensioner or airbag, for example. This poses an increased risk of injury or even fatal injury.

Have the restraint system checked and repaired immediately at a qualified specialist workshop.

Seat belts

Introduction

A correctly worn seat belt is the most effective means of restraining the movement of vehicle occupants in the event of a collision. This reduces the risk of vehicle occupants coming into contact with parts of the vehicle interior or being ejected from it. The seat belt also helps to keep the vehicle occupants in the best position in relation to the airbag being deployed.

The seat belt system consists of:

- seat belts
- belt tensioners for the seat belt of the driver's seat

If the seat belt is pulled quickly or sharply from the belt outlet, the inertia reel locks. The belt strap cannot be pulled out any further.

The belt tensioner tightens the seat belt in the event of a collision so that it fits tightly across your body. However, it does not pull the driver back in the direction of the seat backrest.

The belt tensioner does not, however, correct an incorrect seat position or correct the routing of a seat belt that is worn incorrectly.

Important safety notes

WARNING

If the seat belt is worn incorrectly, it cannot perform its intended protective function. Furthermore, an incorrectly worn seat belt can cause additional injuries, e.g. in the event of an accident, heavy braking or sudden changes of direction. There is an increased risk of injury, possibly even fatal.

Always ensure that all vehicle occupants have their seat belts fastened correctly and are sitting properly.

The components of the restraint system work in conjunction with each other. They can only offer protection if all vehicle occupants always:

- have the seat belt correctly fastened (▷ page 51)
- have the seat adjusted properly (▷ page 73)

Depending on the vehicle's equipment, the head restraints must also be adjusted properly.

WARNING

The seat belt does not offer the intended level of protection if you have not moved the backrest to an almost vertical position. When braking or in the event of an accident, you could slide underneath the seat belt and sustain abdomen or neck injuries, for example. This poses an increased risk of injury or even fatal injury.

Adjust the seat properly before beginning your journey. Always ensure that the backrest is in an almost vertical position and that the shoulder section of your seatbelt is routed across the centre of your shoulder.

WARNING

Persons under 1.50 m tall cannot wear the seat belts correctly without an additional suitable restraint system. If the seat belt is worn incorrectly, it cannot perform its intended protective function. Furthermore, an incorrectly worn seat belt can cause additional injuries, e.g. in the event of an accident, heavy braking or sudden changes of direction. There is an increased risk of injury, possibly even fatal.

Always secure persons less than 1.50 m tall in additional suitable restraint systems.

If a child younger than twelve years old and under 1.50 m in height is travelling in the vehicle:

- Always secure the child in a child restraint system suitable for this Mercedes-Benz vehicle. The child restraint system must be appropriate to the age, weight and size of the child
- Be sure to observe the instructions and safety notes on "Children in the vehicle" (▷ page 54) in addition to the manufacturer's operating and installation instructions for the child restraint system

⚠ WARNING

Seat belts cannot protect as intended, if:

- they are damaged, have been modified, are extremely dirty, bleached or dyed
- the seat belt buckle is damaged or extremely dirty
- modifications have been made to the belt tensioners, belt anchorages or inertia reels

Seat belts may sustain non-visible damage in an accident, e.g. due to glass splinters. Modified or damaged seat belts can tear or fail, for example in the event of an accident. Modified seat belt tensioners may be deployed unintentionally or not function as intended. There is an increased risk of injury, possibly even fatal.

Never modify seat belts, seat belt tensioners, seat belt anchorages and inertia reels. Ensure that seat belts are not damaged or worn and are clean. After an accident, have the seat belts checked immediately at a qualified specialist workshop.

Mercedes-Benz recommends that you use seat belts that have been specifically approved for the relevant vehicle type by Mercedes-Benz. Otherwise, your vehicle's general operating permit could be invalidated.

Correct seat belt use

Observe the safety notes on the seat belt (▷ page 50).

All vehicle occupants must be wearing the seat belt correctly before beginning the journey. Also make sure that all vehicle occupants are always wearing the seat belt correctly while the vehicle is in motion.

When fastening the seat belt, always make sure that:

- the seat belt buckle tongue is inserted only into the belt buckle belonging to that seat
- the seat belt is pulled tight across the body
Avoid wearing bulky clothing, e.g. a winter coat.
- the seat belt is not twisted
Only then can any forces that occur be distributed across the surface of the seat belt.

- the shoulder section of the belt is routed across the centre of the shoulder

The shoulder section of the seat belt should not touch your neck or be routed under your arm or behind your back. If possible, adjust the seat belt to the appropriate height.

- the lap belt is taut and passes across the lap as low down as possible

The lap belt must always be routed across your hip joints and never across your abdomen. This applies particularly to pregnant women. If necessary, press the lap belt down into your hip joints and pull tight with the shoulder section of the belt.

- the seat belt is not routed across sharp, pointed or fragile objects

If you have such items located on or in your clothing, e.g. pens, keys or spectacles, store these in a suitable place.

- only one person is using a seat belt

Infants and children must never travel sitting on the lap of a vehicle occupant. In the event of an accident, they could be crushed between the vehicle occupant and seat belt.

- objects are never secured with a seat belt if the seat belt is also being used by one of the vehicle's occupants

Also ensure that no objects are placed between a person and the seat. e.g. a cushion.

Seat belts are intended only to secure and restrain vehicle occupants. Always observe the instructions and safety notes on "Stowage compartments" for securing objects, luggage or loads (▷ page 107).

Fastening the seat belt

Observe the safety notes on the seat belt (▷ page 50) and the information on the correct use of the seat belt (▷ page 51).



Basic illustration

- ▶ Adjust the seat (▷ page 73). The seat backrest must be in an almost upright position.
- ▶ Pull the seat belt smoothly from belt outlet (3) and engage belt tongue (2) into belt buckle (1). The shoulder section of the seat belt must always be routed across the centre of the shoulder. Adjust the belt outlet if necessary (▷ page 74).
- ▶ If necessary, pull upwards on the seat belt in front of your chest so that the belt sits tightly across your body.

Releasing the seat belt

- ❗ Make sure that the seat belt is fully rolled up. Otherwise, the seat belt or belt tongue will be trapped in the door or in the seat mechanism. This could damage the door, the door trim panel and the seat belt. Damaged seat belts can no longer fulfil their protective function and must be replaced. Visit a qualified specialist workshop.
- ▶ Press release button in belt buckle, hold belt tongue firmly and guide the seat belt back.

Belt warning for the driver

The  seat belt warning lamp in the status area of the on-board computer is a reminder that all vehicle occupants must wear their seat belts. It may light up continuously or flash. In addition, a warning tone may sound.

The  seat belt warning lamp goes out and the warning tone ceases as soon as the driver has fastened the seat belt.

Airbag

Introduction

The driver's airbag installation location is identified by the label AIRBAG.

An airbag supplements a correctly fastened seat belt. It is not a substitute for seat belts. The airbag provides additional protection in the corresponding accident situations.

However, no system available today can completely eliminate injuries and fatalities.

Due to the required speed of the airbag after deployment, it is also not possible to entirely rule out the risk of injuries caused by the airbag.

Important safety notes

WARNING

If you deviate from the correct seat position, the airbag cannot perform its intended protective function and can even cause additional injuries when deployed. There is an increased risk of serious or even fatal injuries.

In order to avoid such risks, always ensure that all vehicle occupants:

- fasten their seatbelts correctly, including pregnant women
- observe the following notes

Always ensure that there are no objects located between the airbag and the vehicle occupant.

- Adjust the seats properly before beginning your journey. Always make sure that the seat is in an almost upright position.
- Move the driver's seat as far back as possible. The seat position must allow the vehicle to be driven safely.
- Hold the steering wheel only by the rim. This allows the airbag to be fully deployed.

- Always lean against the backrest while driving. Do not lean forwards. You may otherwise be in the deployment area of the airbag.
- Always secure persons less than 1.50 m tall in suitable restraint systems. Up to this height, the seat belt cannot be worn correctly.

If a child is travelling in your vehicle, also observe the following notes:

- Always secure children under twelve years of age and less than 1.50 m tall in suitable child restraint systems.
- Be sure to observe the instructions and safety notes on "Children in the vehicle" (> page 54) in addition to the manufacturer's operating and installation instructions for the child restraint system.

Objects in the vehicle interior may prevent the airbag from functioning correctly. Before starting your journey and to avoid risks resulting from the speed of the airbag as it deploys, make sure that:

- there are no people, animals or objects between the driver and the driver's airbag
- no accessories are attached to the vehicle within the deployment area of an airbag, e.g. to the steering wheel or doors
- no heavy, sharp-edged or fragile objects are in the pockets of your clothing. Store such objects in a suitable place.

WARNING

If you modify an airbag cover or affix objects such as stickers to it, the airbag can no longer function correctly. There is an increased risk of injury.

Never modify an airbag cover or affix objects to it.

Driver's airbag

The driver's airbag deploys in front of the steering wheel. When deployed, it offers additional head and thorax protection for the occupant in the driver's seat.

Deployment of the belt tensioner and the driver's airbag

Important safety notes

WARNING

After the airbag deploys, the airbag parts are hot. There is a risk of injury.

Do not touch the airbag parts. Have a deployed airbag replaced at a qualified specialist workshop as soon as possible.

WARNING

Pyrotechnical belt tensioners which have been triggered are no longer operational and therefore cannot protect as intended. There is an increased risk of injury, possibly even fatal. Have pyrotechnic belt tensioners which have been triggered replaced at a qualified specialist workshop immediately.

Mercedes-Benz recommends that you have the vehicle towed to a qualified specialist workshop after an accident. This is particularly important if a belt tensioner or an airbag has been triggered.

If the belt tensioners or airbags are deployed, you will hear a bang, and a small amount of powder may also be released. The  restraint system warning lamp lights up.

Only in rare cases will the bang affect your hearing. The powder that is released generally does not constitute a health hazard, however it may cause short-term breathing difficulties to persons suffering from asthma or other pulmonary conditions. If it is safe to do so, you should leave the vehicle immediately or open a window in order to prevent breathing difficulties.

Mode of operation

During the first stage of a collision, the restraint system control unit evaluates important physical data relating to vehicle deceleration, such as:

- duration
- direction
- intensity

Based on the evaluation of this data, the restraint system control unit triggers the belt tensioner for the seat belt on the driver's seat

and the driver's airbag in the event of a frontal collision.

The belt tensioner can only be triggered if:

- the ignition is switched on
- the components of the restraint system are operational. You can find further information under "Restraint system warning lamp" (> page 49)

The activation threshold for the belt tensioner and driver's airbag is determined by evaluating the cab deceleration. This process is pre-emptive in nature. The triggering process must take place in good time at the start of the collision.

The cab's rate of deceleration and the direction of the force are essentially determined by:

- the distribution of the force during the impact
- the collision angle
- the deformation characteristics of the cab
- the characteristics of the object with which the vehicle has collided

Factors which can only be seen and measured after the collision has occurred do not play a decisive role in the deployment of an airbag. Nor do they provide an indication of airbag deployment.

The vehicle may be deformed significantly without the airbag being deployed. This is the case if only parts which are relatively easily deformed are affected and the rate of deceleration is not high. Conversely, an airbag may be deployed even though the vehicle suffers only minor deformation. This is the case if, for example, very rigid vehicle parts such as longitudinal body members are hit, and sufficient deceleration occurs as a result.

Children in the vehicle

Important safety notes

If a child younger than twelve years old and under 1.50 m in height is travelling in the vehicle:

- always secure the child in a child restraint system suitable for Mercedes-Benz vehicles. The child restraint system must be appropriate to the age, weight and size of the child.
- be sure to observe the instructions and safety notes in this section in addition to the child restraint system manufacturer's installation instructions.

WARNING

If you leave children unattended in the vehicle, they could set the vehicle in motion by, for example:

- releasing the parking brake
- shifting the transmission into neutral
- starting the engine

They could also operate the vehicle's equipment and become trapped. There is a risk of an accident and injury.

When leaving the vehicle, always take the key with you and lock the vehicle. Never leave children unattended in the vehicle.

WARNING

If persons (particularly children) are exposed to heat or cold for a prolonged period, there is a risk of serious or even fatal injuries. Never leave persons (particularly children) unattended in the vehicle.

WARNING

If the child restraint system is placed in direct sunlight, the parts could become very hot. Children could suffer burns by touching these parts, in particular on the metallic parts of the child restraint system. There is a risk of injury.

If you and your child leave the vehicle, always make sure that the child restraint system is not in direct sunlight. Cover it with a blanket, for example. If the child restraint system has been exposed to direct sunlight, leave it to cool down before securing the child in it. Never leave children unattended in the vehicle.

Always ensure that all vehicle occupants have their seat belts fastened correctly and are sitting properly. Particular attention must be paid to children.

Observe the safety notes on the seat belt (> page 50) and the information on the correct use of the seat belt (> page 51).

Child restraint system

WARNING

If the child restraint system is incorrectly fitted on the seat position suitable for this purpose, it cannot perform its intended protective function. In the event of an accident, sharp braking or a sudden change in direction, the child may not be held securely. There is an increased risk of serious or even fatal injuries. Observe the manufacturer's installation instructions and the correct use for the child restraint system. Make sure that the entire surface of the child restraint system is resting on the seat surface. Never place objects under or behind the child restraint system, e.g. cushions. Only use child restraint systems with the original cover designed for them. Only replace damaged covers with genuine covers.

WARNING

If the child restraint system is fitted incorrectly or is not secured, it can come loose in the event of an accident, heavy braking or a sudden change in direction. The child restraint system could be thrown about, striking vehicle occupants. There is an increased risk of injury, possibly even fatal.

Always fit child restraint systems properly, even if they are not being used. Make sure that you observe the child restraint system manufacturer's installation instructions.

Further information on stowing objects, luggage and loads securely can be found under "Stowage compartments" (▷ page 107).

WARNING

Child restraint systems or their securing systems that have been damaged or subjected to a load in an accident cannot perform their intended protective function. In the event of an accident, sharp braking or a sudden change in direction, the child may not be held securely. There is an increased risk of serious or even fatal injuries.

Immediately replace child restraint systems that have been damaged or subjected to a load in an accident. Have the child restraint securing systems checked in a qualified specialist workshop before fitting a child restraint system again.

Observe the warning labels on the child restraint system.

If children are travelling in the vehicle, always observe the safety notes on "Children in the vehicle" as well (▷ page 54).

"Universal"-category child restraint systems can be recognised by their orange approval label.



Example: approval label on the child restraint system

The seat belt system serves as the securing system for child restraint systems.

If you secure a child in a child restraint system on the front-passenger seat, always move the front-passenger seat as far back as possible. The entire base of the child restraint system must always rest on the seat cushion of the front-passenger seat. The backrest of a forward-facing child restraint system must, as far as possible, rest flat against the backrest of the front-passenger seat. The child restraint system must not be put under strain by the head restraint. If possible, adjust the head restraint position accordingly. Always make sure that the shoulder belt strap is correctly routed from the belt sash guide to the shoulder belt guide on the child restraint system. The shoulder belt strap must be routed forwards and downwards from the belt sash guide. If necessary, adjust the belt sash guide accordingly. In addition, always observe the child restraint system manufacturer's installation instructions.

You can obtain child restraint systems and information about the correct child restraint system from any Mercedes-Benz Service Centre.

Pets in the vehicle

WARNING

If you leave animals unsupervised or unsecured in the vehicle, they may push a button or a switch, for example.

They could:

- activate vehicle equipment and become trapped, for example
- switch vehicle systems on or off, thus endangering other road users

In the event of an accident, sudden braking or abrupt changes of direction, unsecured animals could be flung around the vehicle, injuring the vehicle occupants. There is a risk of an accident and injury.

Never leave animals unattended in the vehicle. Always secure animals correctly during a journey, e.g. in an animal transport box.

Useful information

These Operating Instructions describe all the models and standard and optional equipment of your vehicle that were available at the time of going to print. Country-specific differences are possible. Bear in mind that your vehicle may not be equipped with all the functions described. This also applies to safety-relevant systems and functions.

Read the information on qualified specialist workshops (▷ page 31).

Locking system

Mechanical key element

WARNING

If you attach heavy or large objects to the key, the key could be unintentionally turned in the ignition lock. This could cause the engine to be switched off. There is a risk of an accident.

Do not attach any heavy or large objects to the key. Remove any bulky keyrings before inserting the key into the ignition lock.

Your vehicle is equipped with a special key system. The engine can only be started using keys that are coded for the vehicle.

i If a vehicle key is lost, obtaining a replacement is a time-consuming process. This can only be done through a Mercedes-Benz Service Centre.

Mercedes-Benz therefore recommends that you always keep an easily accessible spare key with you for emergencies.

Electronic key

General notes

Your vehicle is equipped with a special key system.

Only if you have keys that are coded for the vehicle, can you:

- switch on the ignition
- start the engine
- engage the gears

i If a vehicle key is lost, obtaining a replacement is a time-consuming process. This can only be done through a Mercedes-Benz Service Centre.

Mercedes-Benz therefore recommends that you always keep an easily accessible replacement key with you for emergencies.

If you lose a key, have it disabled at a Mercedes-Benz Service Centre. This prevents the lost key from being misused.

Key variants



NB0.00-2022-31

Key without remote control



NB0.35-2044-31

Key with remote control



NB0.35-2045-31



Multifunction key

Your vehicle can be equipped with one or several of the following key variants:

- Key without remote control
- Key with remote control
- Multifunction key

A mechanical key element is integrated in each key with which you can lock/unlock the doors without using the remote control.

If the vehicle is equipped with a lockable fuel tanks, you receive additional mechanical key elements for the lockable fuel tank caps.

You can use the  and  buttons to operate the central locking and the convenience opening and closing functions (▷ page 62).

The remote control works regardless of the direction in which it is pointed. You can lock/unlock the vehicle from a distance of up to approximately 30 m. Only use the remote control in the immediate vicinity of the vehicle. This helps to prevent theft.

The key with remote control contains a battery. When this remote control battery is discharged, the on-board computer displays an appropriate event window. Replace the battery in the key (▷ page 65).

There is a rechargeable battery in the multifunction key. The rechargeable battery is charged automatically when the ignition lock is in the driving position. Replace the rechargeable battery if it is malfunctioning (▷ page 65).

Integrated key

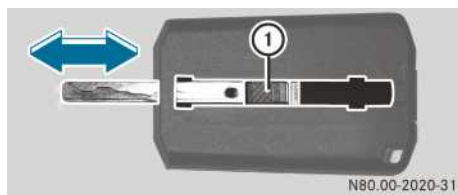

Key with/without remote control



Multifunction key

- ▶ Key with/without remote control: press release button ① and push the integrated key forwards until it engages.
- ▶ Multifunction key: slide release catch ② in the direction of the arrow and pull integrated key ③ out.

Unlock/lock the doors with the integrated key. Afterwards, slide the integrated key all the way back into the key (▷ page 61).

Multifunction key

Operating the multifunction key



- ① Main menu register
- ② Display area for the menu window
- ③ Navigation button
- ④ Confirmation button
- ⑤ Rechargeable battery charge level
- ⑥ Key radio signal strength
- ⑦ Sub-menu register





The multifunction key has a display and a control panel. With the multifunction key you can operate various functions, such as the on-board computer and additional functions, from a distance of up to approximately 100 m. The distance at which these functions are operable using the remote control is heavily dependent on the surroundings. The range is furthest in the open air and with direct visual contact.

- ▶ **To activate the key:** press confirmation button ④ for approximately 2 seconds.
- ▶ **To scroll through the main menus:** press left or right on navigation button ③.
- ▶ **To scroll through the sub-menus:** press up or down on navigation button ③.
- ▶ **To open and close a selection in the sub-menu:** press confirmation button ④.
- ▶ **To select a menu bar:** press up or down on navigation button ③.
- ▶ **To change a value or select an entry:** press left or right on navigation button ③.
- ▶ **To deactivate the key:** press confirmation button ④ for approximately 2 seconds.

i The display fades out if you do not press any buttons on the multifunction key before the set standby time has elapsed. The multifunction key then deactivates itself if no buttons are pressed before the set switch-off time has elapsed.

Main menus







-  Vehicle check
-  Operation
-  Comfort
-  Settings on the multifunction key

Menus in detail

The number and order of the menu depends on your vehicle's equipment and the type of vehicle itself. The following menus correspond to a certain extent with those in the on-board computer. Some of the functions can only be operated when the ignition is switched on or the engine is running. In this case, use the ignition run-on (> page 239) or engine run-on (> page 239) functions.

 Vehicle check

The display show the levels of fuel  and AdBlue® . Further information on fuel/AdBlue® levels and range can be found in the "On-board computer and displays" section (> page 138).

The display shows the reservoir pressure in brake circuits  and .

 Vehicle check



The display shows . The lamp check assists you in making your departure checks and helps you identify defective bulbs.

- ▶ Apply the parking brake.
- ▶ Select lamp check.
 - Dipped-beam headlamps, marker lamps, tail lamps and licence plate lighting light up permanently. Turn signals, main-beam headlamps, brake lights, daytime driving lights, reversing lamps, foglamps and working-area lamps are switched on one after the other. This cycle is repeated three times.

If you want to cancel the lamp check, press the enter key again or release the parking brake.

The display shows the  battery voltage of the vehicle batteries.

 Operation

The display shows the engine's total distance recorder  and operating hours .

The display shows  and the tyre pressure. Refer to the "On-board computer and displays" section for further information on the tyre pressure monitor (> page 144).

The display shows the axle loads and the gross weight if:

- the vehicle is stationary
- the driving level is active
- the ignition lock is in driving position, ignition run-on function (> page 239)

Refer to the "On-board computer and display" section (> page 145) for further information.

The display shows . You can unlock/lock the loading tailgate. Refer to the body manufacturer's operating instructions for further information.

Operation

The display shows . The working area lamp can be switched on/off.

The display shows . If the ignition lock is in the driving position (ignition run-on (> page 239) or engine run-on (> page 239)), you can operate the level control with the multifunction key as you would with the on-board computer. Refer to the information on level control in the "On-board computer and displays" section (> page 145).

Comfort

The display shows the outside temperature and, on vehicles with automatic climate control, also the interior temperature.

The display shows . The auxiliary heating can be switched on/off. Refer to the "Climate control" section (> page 125) for further information on auxiliary heating.

The display shows . The auxiliary climate control can be switched on/off. Refer to the "Climate control" section (> page 123) for further information on auxiliary climate control.

The display shows . Interior lighting, nightlight and ambient lighting can be switched on/off. Refer to the "On-board computer and displays" section (> page 149) for further information on lighting.

The display shows . You can see which exterior flaps and doors are open and closed and whether the vehicle is locked or unlocked.

The display shows .

The following audio system functions can be operated:

- switching on/off
- source selection
- station/track selection
- volume adjustment
- mute function

Multifunction key settings

The display shows . The brightness of the key display can be adjusted.

The display shows .

You can set the units that are shown on the display for:

- pressure
- distance
- temperature
- weight

The display shows  and the charge level of the rechargeable battery in the multifunction key.

The display shows  and the signal strength of the multifunction key.

The display shows . You can adjust the standby and switch-off times.

The display shows  and the system information of the multifunction key.

Central locking

Important safety notes

-  Only open the doors when traffic conditions permit. Make sure that there is sufficient clearance when opening the doors. Otherwise, you could damage your vehicle or other vehicles.

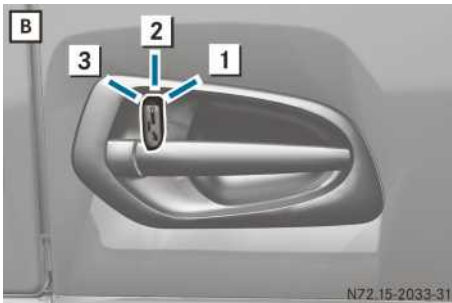
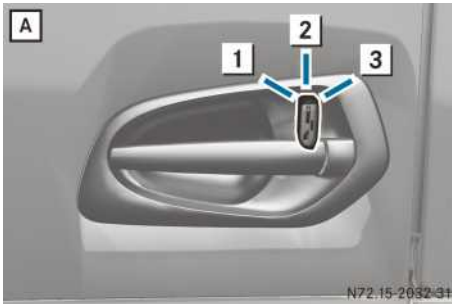

External door lock

Unlocking and locking using the key



- i** Key with remote control and multifunction key: the alarm is triggered if the door is unlocked with the integrated key while ATA is primed.
- ▶ Insert the key into the lock of the left-hand door **A** or the right-hand door **B** in position **2**.
- ▶ **To unlock:** turn the key to position **1**. The corresponding door is unlocked.
- ▶ **To lock:** turn the key to position **3**. Both doors are locked.
- ▶ **To open:** remove the key from position **2**.
- ▶ Pull the door handle.

Unlocking/locking with the remote control

- ▶ **To unlock:** press the  button on the remote control/multifunction key. The driver's door or both doors are unlocked.
- i** You can change the unlocking function of the remote control so that either both front doors or just the driver's door is unlocked when you press the  button. To switch between the two unlocking functions, press

and hold both remote control buttons simultaneously for approximately 30 seconds. If you have selected the function that only unlocks the driver's door, you can unlock the co-driver's door by pressing the  button again.

- ▶ **To lock:** press the  button on the remote control/multifunction key. Both doors are locked.

Interior door lock

Unlocking using the door handle





Door handle (example: left-hand door)

- ▶ Pull the door handle.

Locking/unlocking centrally using the buttons



Door control panel (example: left-hand door)

- ▶ Close both doors.
- ▶ **To lock centrally:** press the left-hand section of the  button.
- ▶ **To unlock centrally:** press the right-hand section of the  button. The indicator lamp in the  button flashes briefly.

Enhanced central locking system

⚠ WARNING

When the convenience closing feature is operating, parts of the body could become trapped in the closing area of the side window and the sliding sunroof. There is a risk of injury.

Observe the complete closing procedure when the convenience closing feature is operating. When closing make sure that no parts of the body are in the closing area.

⚠ WARNING

Limbs could get trapped if they are in the sweep of the sliding sunroof/pop-up roof when opening and closing. There is a risk of injury.

Make sure that no one's limbs are in the sweep of the sliding sunroof/pop-up roof when opening and closing.

If someone does get trapped:

- release the button immediately or
- press the top of the button again

The closing procedure is stopped.

⚠ WARNING

While closing the side windows, body parts in the closing area could become trapped. There is a risk of injury.

When closing make sure that no parts of the body are in the closing area. If somebody becomes trapped, release the switch or press the switch to open the side window again.

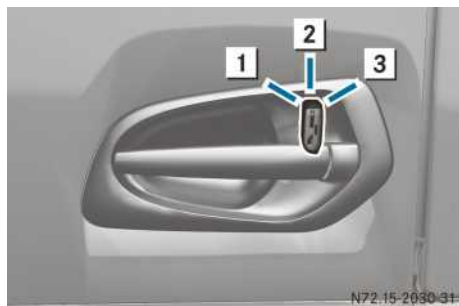

Door lock (example: left-hand door)

- ▶ **Convenience closing:** insert the integrated key into driver's door in lock position **2**, then turn it to position **3** and hold it there.

or

- ▶ Vehicles without ATA: press and hold the  button on the remote control/multifunction key for approximately 2 seconds.

or

- ▶ Vehicles with ATA: press the  button on the remote control/multifunction key. All turn signals flash three times. The doors are locked. The side windows and the sliding sunroof/pop-up roof close.

- ⓘ The roof hatch is not closed.

If there is a risk of becoming trapped:

- ▶ Turn the integrated key to position **1** immediately and hold it there until the side windows and the sliding sunroof/pop-up roof open again.

or

- ▶ Press and hold the  button of the remote control/multifunction key until the side windows and the sliding sunroof/pop-up roof open again. The driver's door is unlocked.

- ▶ **Convenience opening:** insert the integrated key into position **2** in the driver's door lock, then turn it to position **1** and hold it there.

or

- ▶ Press and hold the  button on the remote control/multifunction key until the side windows and the sliding sunroof/pop-up roof have reached the desired position. All turn signals flash once. The driver's door is unlocked. The side windows and the sliding sunroof/pop-up roof open automatically.

- ⓘ The roof hatch is not opened.

ATA (Anti-Theft Alarm system)

General notes

ATA protects the vehicle from break-in and theft.

ATA monitors:

- on the tractor vehicle:
 - the doors
 - the exterior flaps
 - the power supply
 - the cab tilt lock
 - the vehicle interior (can be deactivated)
 - the maintenance flap
 - the fuel tank
- the box-type bodies
- the 24 V power supply of the trailer/semi-trailer

Vehicles for the transport of hazardous goods: if ATA is primed and the power supply is interrupted using the battery isolator switch (▷ page 102), the alarm is triggered. The on-board computer displays an according message in an event window.

Bear the following in mind:

- When ATA is primed, it confirms the locking procedure by flashing all turn signals three times. If the turn signals do not flash three times, one or more components are not in the rest position. ATA cannot then monitor these components, e.g. open exterior flaps.
- Components that are moved to the rest position within approximately 30 seconds of ATA being primed will be monitored.
- If you subsequently close the exterior flaps and want to include them in the monitoring, prime ATA again.

ATA alarm

If ATA triggers an alarm:

- all turn signals flash for approximately 5 minutes and
- the alarm siren sounds for approximately 30 seconds

If you turn the ignition lock to the drive position after an alarm has been triggered, the on-board computer displays the alarm trigger data along with the date and time in an event window.

Before ATA is primed

- ▶ Close the roof hatch, sliding sunroof or pop-up roof.
- ▶ Close the windows.
- ▶ Draw back the curtains.

- ▶ Close the exterior flaps.
- ▶ Detach/remove any loose objects in the cab, e.g. mascots or coat hangers.

Priming and deactivating ATA

Priming ATA with interior motion sensor

WARNING

Limbs could get trapped if they are in the sweep of the sliding sunroof/pop-up roof when opening and closing. There is a risk of injury.

Make sure that no one's limbs are in the sweep of the sliding sunroof/pop-up roof when opening and closing.

If someone does get trapped:

- release the button immediately or
- press the top of the button again

The closing procedure is stopped.

WARNING

While closing the side windows, body parts in the closing area could become trapped. There is a risk of injury.

When closing make sure that no parts of the body are in the closing area. If somebody becomes trapped, release the switch or press the switch to open the side window again.



ATA button with indicator lamp and panic alarm

- ▶ Remove the key from the ignition lock.
- ▶ Turn the integrated key to the locking position in the door lock of the driver's door and hold it for approximately 2 seconds. Then turn the integrated key back to the rest position and remove it.

or

- ▶ Press  on the key with remote control or the multifunction key.

All turn signals flash three times and the indicator lamp in the  button flashes. The vehicle is locked.

Vehicles with enhanced central locking system: the windows and the sliding sunroof/pop-up roof close.

- i** The roof hatch is not closed.

Priming ATA without interior motion sensor

If persons or animals are to remain in the cab, prime ATA without the interior motion sensor.

- ▶ Remove the key from the ignition lock.
- ▶ Briefly press the top of the  button. The indicator lamp in the button lights up. For the next locking operation, the interior motion sensor remains deactivated.
- ▶ Get out of the vehicle within approximately 60 seconds and close the driver's door.
- ▶ Lock the vehicle with the integrated key or by remote control.

or

- ▶ Press the upper section of the  button for more than 2 seconds. (Not for the Netherlands.)



The vehicle is locked and all the turn signals flash three times. ATA is primed.

If you switch on the ignition, ATA is deactivated automatically.

Deactivating ATA/cancelling the alarm

- ▶ Press  on the key with remote control or the multifunction key and open the driver's door.

or

- ▶ If ATA was primed using the  button, press the upper section of the  button again for longer than 2 seconds. (Not for the Netherlands.)

All turn signals flash once.

- i** If ATA is deactivated with the remote control and a door is not opened within 25 seconds:
 - the vehicle is locked and
 - ATA is primed again

If you switch on the ignition, ATA is deactivated automatically.

Triggering and deactivating the panic alarm

WARNING

Limbs could get trapped if they are in the sweep of the sliding sunroof/pop-up roof when opening and closing. There is a risk of injury.

Make sure that no one's limbs are in the sweep of the sliding sunroof/pop-up roof when opening and closing.

If someone does get trapped:

- release the button immediately or
- press the top of the button again

The closing procedure is stopped.

WARNING

While closing the side windows, body parts in the closing area could become trapped. There is a risk of injury.

When closing make sure that no parts of the body are in the closing area. If somebody becomes trapped, release the switch or press the switch to open the side window again.

An alarm can be triggered manually with the  button if danger threatens, for example.

- ▶ **To trigger:** press the lower section of the  button. The alarm is triggered and the vehicle is locked.

Vehicles with enhanced central locking system: the windows and the sliding sunroof/pop-up roof close.

- i** The roof hatch is not closed.
- ▶ **To deactivate:** press the lower section of the  button again. The alarm ceases and the vehicle is unlocked.

Battery and rechargeable battery of the key

Important safety notes

⚠ WARNING

Batteries contain toxic and corrosive substances. If batteries are swallowed, it can result in severe health problems. There is a risk of fatal injury.

Keep batteries out of the reach of children. If a battery is swallowed, seek medical attention immediately.

♻ Environmental note



Batteries and rechargeable batteries contain pollutants. It is illegal to dispose of them as household rubbish. They must be collected separately and recycled in an environmentally responsible manner.



Dispose of batteries and rechargeable batteries in an environmentally responsible manner. Take discharged batteries or faulty rechargeable batteries to a qualified specialist workshop or to a collection facility for used batteries.

When the remote control battery is discharged, the vehicle can no longer be locked and unlocked with the remote control. The on-board computer indicates that the battery charge level is low.

Replacing the battery

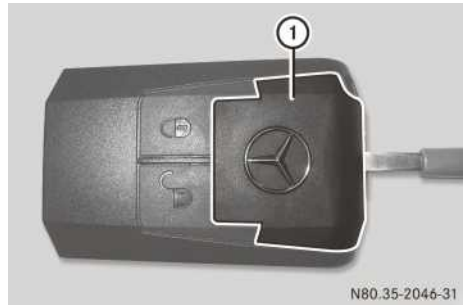

- ▶ Insert a screwdriver approximately 1 mm into the recess on the key with remote control and prise cover ① open.
- ▶ Remove cover ①.
- ▶ Tap the key with remote control on the palm of your hand until the battery falls out.
- ▶ Insert the new battery into the key with remote control with its positive pole facing upwards.
- ▶ Clip cover ① on at the front and engage at the back.

Use a CR2025 battery.

Replacing the battery

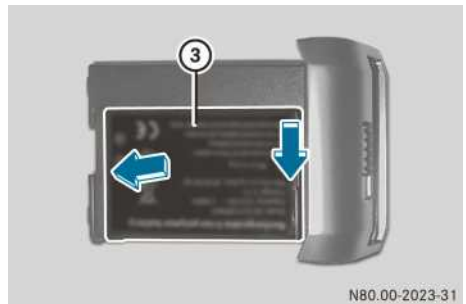
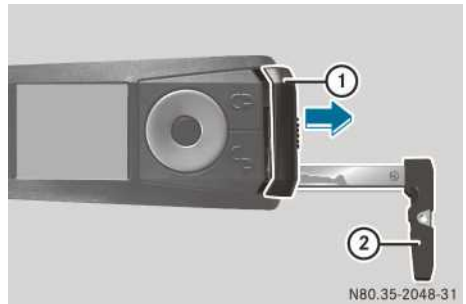

The multifunction key battery is charged automatically via the ignition lock. A new rechargeable battery can be ordered at a Mercedes-Benz Service Centre.

- ▶ Remove integrated key ② (▷ page 57).
- ▶ Insert integrated key ② into the multifunction key and press it towards the middle until battery tray ① is released.

- ▶ Remove battery tray ①.
- ▶ Lift battery ③ at the back and remove it from battery tray ①.
- ▶ Insert new battery ③ first at the front and then engage at the back.
- ▶ Slide battery tray ① and integrated key ② back into the multifunction key.

Problems with the locking system

Problem	Possible causes/consequences and ▶ Solutions
When the ATA (anti-theft alarm system) is primed, there is no acknowledgement from the turn signal lamps.	<p>One of the monitored components has not been locked correctly.</p> <ul style="list-style-type: none"> ▶ Switch off ATA (▷ page 62). ▶ Check that the monitored components are locked, e.g.: <ul style="list-style-type: none"> • doors • windows • cab tilt lock • the exterior flaps on the driver's and co-driver's side • maintenance flap ▶ Prime ATA (▷ page 62). ▶ If there is no visual acknowledgement, have ATA checked at a qualified specialist workshop.

Getting into/out of the vehicle

WARNING

If you leave children unattended in the vehicle, they could set the vehicle in motion by, for example:

- releasing the parking brake
- shifting the transmission into neutral
- starting the engine

They could also operate the vehicle's equipment and become trapped. There is a risk of an accident and injury.

When leaving the vehicle, always take the key with you and lock the vehicle. Never leave children unattended in the vehicle.

Ensure that you observe the safety notes in the "Children in the vehicle" section (▷ page 54). Safe entry and exit from the vehicle can only be guaranteed if you use the grab handles and

steps. Only these are designed to withstand the necessary weight. Do not jump down from the cab.

Keep steps, door sills, grab handles and footwear free from dirt, such as:

- mud
- clay
- snow
- ice

This increases the safety of your footing.

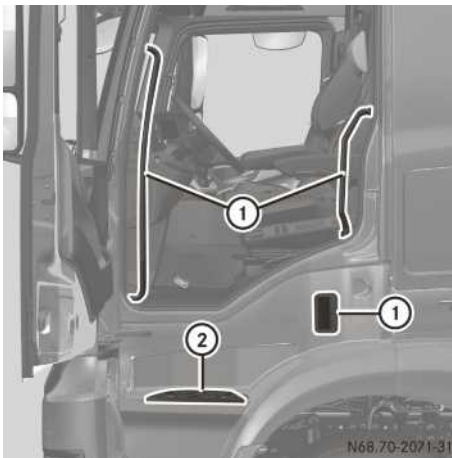

Getting into and out of the vehicle (example: left-hand door)

- ▶ Use the EASY-ENTRY/EXIT system of the suspension seat (▷ page 74).
- ▶ Use grab handles ① and steps ② when getting in and out of the vehicle.

Side windows

Important safety notes

WARNING

While opening the side windows, body parts could become trapped between the side window and the door frame as the side window moves. There is a risk of injury.

Make sure that nobody touches the side window during the opening procedure. If somebody becomes trapped, release the switch or pull the switch to close the side window again.

WARNING

While closing the side windows, body parts in the closing area could become trapped. There is a risk of injury.

When closing make sure that no parts of the body are in the closing area. If somebody becomes trapped, release the switch or press the switch to open the side window again.

WARNING

If you close a side window again immediately after it has been blocked or reset, the side window closes with increased or maximum force. The reversing function is then not active. Parts of the body could be trapped in the closing area in the process. This poses an increased risk of injury or even fatal injury.

Make sure that no parts of the body are in the closing area. To stop the closing process, release the switch or push the switch again to reopen the side window.

After a malfunction or voltage supply interruption, reset the side windows (▷ page 68).

Opening and closing the side windows

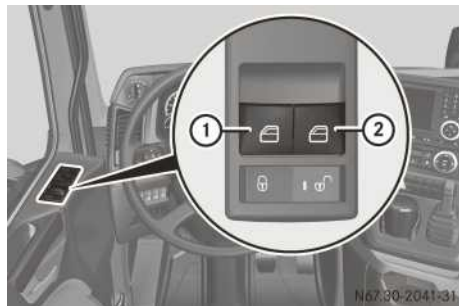

Switch panel (example: driver's door)

Buttons for the driver's and co-driver's side windows are located on the driver's door switch panel. The co-driver's door switch panel contains only the button for the co-driver's side window.

The side windows can also be opened with the key and, on vehicles with the enhanced central locking system, also closed with the key (▷ page 62).

- ▶ Switch the ignition lock to the radio position.
- ▶ **To open/close:** press or pull button ① or ② until the appropriate side window has reached the desired position.
- ▶ **Convenience opening:** push button ① or ② past the point of resistance. The corresponding side window opens fully.

- ▶ **Convenience closing (vehicles with the enhanced central locking system):** pull button ① or ② past the point of resistance. The corresponding side window closes completely. If the side window is obstructed while closing, the automatic re-opening function halts its movement.

If the side window is obstructed and you pull and hold corresponding button ① or ②, the window closes without the automatic re-opening function.

- ▶ **To interrupt convenience closing/opening:** push or pull corresponding button ① or ② again.

Resetting the side windows

Reset the side window after a voltage supply interruption or if a side window no longer closes or opens completely.

- ▶ Switch the ignition lock to the radio position.
- ▶ Press button ① and/or ② until the corresponding side window is open.
- ▶ Press button ① and/or ② for another second.
- ▶ Pull button ① and/or ② until the corresponding side window is closed.
- ▶ Press button ① and/or ② for another second.

Roof

Sliding sunroof and pop-up roof

Opening/closing

WARNING

Limbs could get trapped if they are in the sweep of the sliding sunroof/pop-up roof when opening and closing. There is a risk of injury.

Make sure that no one's limbs are in the sweep of the sliding sunroof/pop-up roof when opening and closing.

If someone does get trapped:

- release the button immediately or
- press the top of the button again







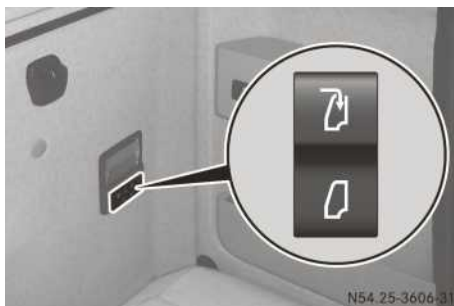

The closing procedure is stopped.



Sliding sunroof/pop-up roof button (example: in switch panel above the windshield)



Sliding sunroof/pop-up roof button (example: in berth switch panel)

- ▶ **To open:** briefly press the upper section of the  switch. The sliding sunroof is raised. The pop-up roof opens completely.
 - ▶ To stop movement, press the  or  switch.
 - ▶ For a sliding sunroof, press the upper section of the  button and hold it until the sliding sunroof has reached the desired position.
 - ▶ **To close:** for the sliding sunroof, press and hold the  button until the sliding sunroof reaches the desired position.
- or
- ▶ Briefly press the lower section of the  button. The sliding sunroof or pop-up roof closes completely.
 - ▶ To stop movement, press the  or  switch.

During a malfunction or after the battery has been disconnected, you can also close the sliding sunroof or pop-up roof manually – sliding sunroof (> page 69), pop-up roof (> page 70).

Reset the sliding sunroof after a malfunction or voltage supply interruption (> page 70).

Sun screen/insect screen

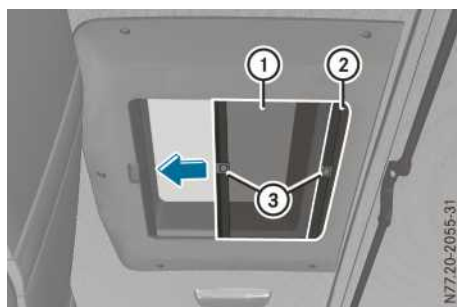

Example, sliding sunroof: roller blinds

The pop-up roof and the sliding sunroof are equipped with an insect screen ①. The sliding sunroof also has a shade ②. On a sliding sunroof, you can close only one blind.

- ▶ **To close:** pull the blind by handle ③ up to the opposite end of the roof frame.
- ▶ Push and release handle ③ lightly downwards on the catch. The blind hooks in.
- ▶ **To open:** push the blind by handle ③ all the way in the direction of closing.
- ▶ Push handle ③ upward and unhook the blind.
- ▶ Guide the blind back to the opposite end of the roof frame and release handle ③.

Closing the sliding sunroof manually

Vehicles with ClassicSpace/CompactSpace cab



Vehicles with ClassicSpace cab



Vehicles with CompactSpace cab

- ▶ Take the Allen key from the vehicle document wallet.
- ▶ Vehicles with ClassicSpace cab: remove protective cap ①.
- ▶ Vehicles with CompactSpace cab: remove cover ②.



- ▶ Pass Allen key ③ through the opening and insert it into the actuator.
- ▶ Turn Allen key ③ clockwise until the sliding sunroof is completely closed.
- ▶ Remove Allen key ③ and return it to the vehicle document wallet.
- ▶ Vehicles with ClassicSpace cab: refit protective cap ①.
- ▶ Vehicles with CompactSpace cab: fit cover ②.

Vehicles with BigSpace/StreamSpace/GigaSpace cab

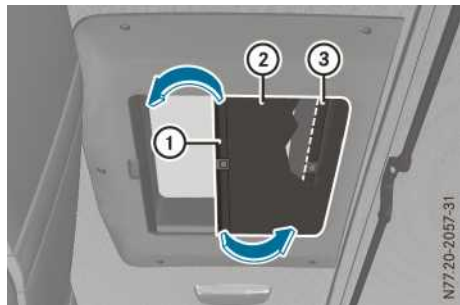

- ▶ Take the Allen key from the vehicle document wallet.
- ▶ Pull out shade ② by the handle to the centre of the roof frame.
- ▶ Turn guide rod ① of the blind and remove it on both sides of the blind guides in the roof frame.
- ▶ Guide shade ② carefully back until the blind stops, and hang it in the cab.
- ▶ Remove insect screen ③ as previously described for shade ②, out of the blind guide in the roof frame and hang it in the cab.



- ▶ If necessary, press the blinds against the roof frame and fit Allen key ⑤ through opening ④ on the actuator motor.
- ▶ Turn Allen key ⑤ clockwise until the sliding sunroof is completely closed.
- ▶ Remove Allen key ⑤ and return it to the vehicle document wallet.
- ▶ Insert guide rod ① of insect screen ③ in the blind guides of the roof frame, turn it parallel to the end position and guide the blind back into the end position.
- ▶ Insert guide rod of shade ② in the blind guides of the roof frame, turn it parallel to the end position and guide shade ② back into the end position.

Resetting the sliding sunroof

Reset the sliding sunroof after a voltage supply interruption or if operation is jerky.

- ▶ Press and hold the  button until the sliding sunroof has been completely closed for approximately 3 seconds.

Closing the pop-up roof manually

Vehicles with ClassicSpace cab



- ▶ Remove flat-blade screwdriver (blade width 4 mm) ② from the vehicle tool kit.
- ▶ Remove the covering cap from opening ①.
- ▶ Insert flat-blade screwdriver ② into the actuator through opening ①.
- ▶ Turn flat-blade screwdriver ② anti-clockwise until the pop-up roof is completely closed.
- ▶ Remove flat-blade screwdriver ② and replace it in the vehicle tool kit.
- ▶ Insert the covering cap into opening ①.

**Vehicles with BigSpace/StreamSpace/
GigaSpace cab**

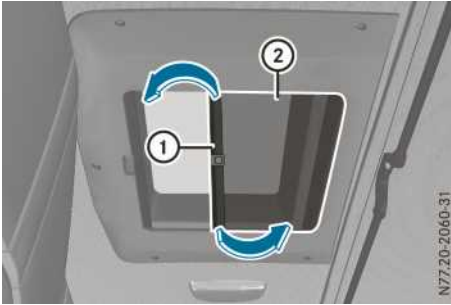

Vehicles with BigSpace/StreamSpace/GigaSpace cab

- ▶ Remove flat-blade screwdriver (blade width 4 mm) from the vehicle tool kit.
- ▶ Pull out insect screen ② by the handle to the centre of the roof frame.
- ▶ Turn guide rod ① of insect screen ② and remove it on both sides of the blind guides in the roof frame.
- ▶ Guide insect screen ② carefully back until it stops, and hang it in the cab.



- ▶ If necessary, press the insect screen against the roof frame and insert flat-blade screwdriver ④ through opening ③ and position on the actuator motor.
- ▶ Turn flat-blade screwdriver ④ anti-clockwise until the pop-up roof is completely closed.
- ▶ Remove flat-blade screwdriver ④ and replace it in the vehicle tool kit.
- ▶ Insert guide rod ① of insect screen ② in the blind guides of the roof frame, turn it parallel to the end position and guide the blind back into the end position.

Roof hatch



You can open the roof hatch at one end (at the front or rear) or at both ends (at the front and rear).

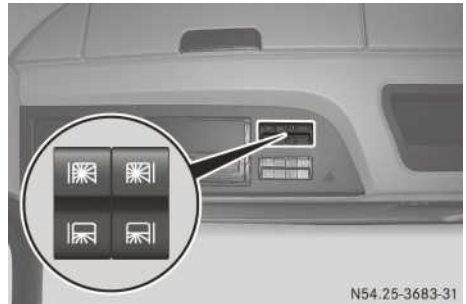

- ▶ Push the roof hatch up or pull it down by handles ①.

Roller sunblind



If you switch the ignition lock into drive position while the roller sunblinds are not in the extreme upper position, a reference run starts and the roller sunblinds are retracted completely.





- ▶ Switch the ignition lock to the drive position.
- ▶ **To extend:** briefly press the or button downwards. The roller sunblinds extend to the extreme position.
- or
- ▶ Press the or button downwards until the corresponding roller sunblind has reached the desired position.

- ▶ **To retract:** briefly push the  or  button upwards.
The roller sunblinds are retracted to the extreme position.

or

- ▶ Push the  or  button upwards until the corresponding roller sunblind has reached the desired position.

- ▶ **i** If an error has occurred and you press the button, the roller sunblind carries out a reference run. The roller sunblind is retracted into the extreme upper position at a slower speed than normal. The roller sunblind is now ready for normal operation.

- ▶ If a reference run is interrupted, press the  or  button and then press the  or  button immediately afterwards.
The roller sunblind is retracted to the extreme upper position.

Useful information

These Operating Instructions describe all the models and standard and optional equipment of your vehicle that were available at the time of going to print. Country-specific differences are possible. Bear in mind that your vehicle may not be equipped with all the functions described. This also applies to safety-relevant systems and functions.

Read the information on qualified specialist workshops (▷ page 31).

Seats

Important safety notes

WARNING

You could lose control of the vehicle while driving if you:

- adjust the driver's seat, steering wheel or mirrors
- fasten the seat belt

There is a risk of an accident.

Adjust the driver's seat, head restraint, steering wheel and mirrors and fasten your seat belt before starting the engine.

WARNING

When adjusting a seat, you or another vehicle occupant could become trapped by the guide rail of the seat, for instance. There is a risk of injury.

Make sure that no one has any part of their body within the sweep of the seat when adjusting it.

WARNING

The seat belt does not offer the intended level of protection if you have not moved the backrest to an almost vertical position. When braking or in the event of an accident, you could slide underneath the seat belt and sustain abdomen or neck injuries, for example. This poses an increased risk of injury or even fatal injury.

Adjust the seat properly before beginning your journey. Always ensure that the backrest is in an almost vertical position and that the shoulder section of your seatbelt is routed across the centre of your shoulder.

WARNING

If the driver's seat is not correctly engaged, it could unexpectedly move while driving. This could cause you to lose control of the vehicle. There is a risk of an accident.

Always ensure that the driver's seat is engaged before starting the vehicle.

WARNING

The head restraints cannot provide the intended protection unless they are fitted and adjusted correctly. There is an increased risk of injury to the head and neck in the event of an accident or sudden braking, for example.

Always drive with the head restraints fitted. Ensure that the centre of the head restraints support the back of each vehicle occupant's head at eye level before driving off.

WARNING

If there is not enough clearance, the suspension seat could trap body parts between the steering wheel and the suspension seat. There is a risk of injury.

Ensure that there is enough clearance for the movements of the suspension seat. Before getting out, lower the suspension seat completely.

WARNING

If you push the suspension seat bellows inwards, your hand could become trapped. There is a risk of injury.

Do not push the bellows inwards.

! To prevent damage to the seats and the seat heating, observe the following notes:

- Do not pour any fluid on the seats. If fluid is poured on the seats, dry it as quickly as possible.
- If the seat covers are damp or wet, do not switch on the seat heating. Also, do not use the seat heating to dry the seats.
- Clean the seat covers as recommended; see the "Cleaning and care" section.
- Do not transport any heavy loads on the seats. Do not place any pointed objects on the seat cushions, such as e.g. knives, nails or tools. As far as possible, only use the seats for people.
- When operating the seat heating, do not cover the seats with insulating materials, e.g. blankets, coats, bags, protective covers, child seats or booster seats.

! Ensure that no objects in the cab are blocking the seats. The seats could otherwise be damaged.

Your seat must be adjusted in such a way that you can fasten your seat belt correctly. Observe the following points:

- set the seat backrest to a position as near to vertical as possible and sit as upright as possible. Never drive with the seat backrest reclined too far back.
- your arms should be slightly bent when you are holding the steering wheel.
- avoid seat positions which do not allow the seat belt to be routed correctly. The shoulder section of the belt must be routed across the centre of your shoulder and be pulled tightly against your upper body. The lap belt must always be routed across your lap tightly and as low down as possible, i.e. across your hips.
- maintain a distance to the pedals that allows you to depress them fully.

Your vehicle may be equipped with different types of seats depending on the cab and the vehicle's equipment:

- static seat without suspension
- standard suspension seat
- luxury suspension seat
- air-conditioned suspension seat
- co-driver's and centre seat
- function seat
- corner seat

Also observe the safety notes on the airbag system (▷ page 52) and on children in the vehicle (▷ page 54).

If your vehicle is equipped with a suspension seat, always use the EASY-ENTRY/EXIT feature when getting out of the vehicle.

To operate a suspension seat, a reservoir pressure of at least 7 bar is required in your vehicle's compressed-air system.

Do not use the seat as a step to help you access the upper berth, for example.

A seat with an integrated seat belt is a safety-relevant component and restraint system.

Ensure that you read the safety guidelines in the "Occupant safety" section (▷ page 50).

Information on seat cleaning can be found in the "Cleaning and care" section (▷ page 349).

Always have work on the seats performed at a qualified specialist workshop.

Operating the seats

Static seat, centre seat and standard/comfort/air-conditioned suspension seat

! The seat heating/ventilation does not switch off automatically in the event of overheating.

Observe the following instructions, as you could otherwise damage the seat heating/ventilation:





- do not leave any objects on the seat.
- do not cover the seat, e.g. with a towel or cushion.
- if the co-driver's seat is not occupied, switch the seat heating and ventilation off on the co-driver's side.
- when the engine is not running, switch the seat heating and ventilation off on the driver's and the co-driver's side.

! When you adjust the seat fore-and-aft position, ensure that the head section of the lower berth is fully down. Otherwise, the head section may hit the seat and damage both components.



Example: air-conditioned suspension seat

Before adjusting the seat, read the important safety notes about the seats. Depending on the seat design, some adjustment options may not be available.

- ▶ When adjusting the seat, make sure that there is sufficient clearance, in particular behind the seat.
- ▶ **To adjust the neck cushion:** press the press studs on the rubber straps and adjust neck cushion ② accordingly to suit your height.
- ▶ Release the press studs.
- ▶ **To set the belt height:** press and hold the button on belt sash guide ①.
- ▶ Adjust belt sash guide ① accordingly to suit your height.
- ▶ Release the button.
- ▶ **To adjust the armrests:** swing seat armrests ③ upwards.
- ▶ Use the handwheel on the underside to set the angle of seat armrests ③.
- ▶ **To adjust the seat cushion angle:** press lever ④ downwards and hold it.
- ▶ Apply weight to or relieve the seat cushion or backrest of any weight in order to move it into the desired position.
- ▶ Release lever ④.
- ▶ **To adjust the backrest:** relieve the backrest of any weight.
- ▶ Pull lever ④ up and hold it.
- ▶ Apply weight to or relieve the seat backrest of any weight in order to move it into the desired position.
- ▶ Release lever ④.
- ▶ **To set the upper portion of the backrest:** pull lever ⑮ on the rear of the backrest upward and hold it.
- ▶ Tilt the upper portion of the seat backrest to the desired position.
- ▶ Release lever ⑮.
- ▶ **To adjust the seat height:** pull lever ⑤ up or push it down one level. The seat is raised or lowered by one level.
- ▶ **To set the seat fore-and-aft adjustment:** pull lever ⑨ upwards and hold it.
- ▶ Push the seat forwards or backwards in order to move it into the desired position.
- ▶ Release lever ⑨.
- ▶ Slide the seat forwards or backwards until it engages audibly.
- ▶ **To adjust the seat cushion length:** pull lever ⑫ upwards and hold it.
- ▶ Push the seat cushion forwards or backwards in order to move it into the desired position.
- ▶ Release lever ⑫.
- ▶ **To adjust the oscillation damper:** set the oscillation damper level by level using lever ⑪ to prevent the seat from bottoming out.
- ▶ **To release the seat fore-and-aft suspension lock:** move lever ⑬ downwards. The seat is able to oscillate freely.
- ▶ **To engage the seat fore-and-aft suspension lock:** move lever ⑬ upwards. The seat fore-and-aft suspension engages and the seat suspension is locked in place.
- ▶ **To switch on the seat heating:** press the  upper section of switch ⑥. The seat heating is active and is set to the first heating level.
- or
- ▶ Press the  lower section of switch ⑥. The seat heating is active and is set to the second heating level.
- ▶ **To deactivate the seat heating:** press switch ⑥ into the centre position.
- ▶ **To switch on seat ventilation:** turn  blower control unit ⑦ from position 0 downward. The airflow increases in 3 levels.
- ▶ **To switch off seat ventilation:** turn  blower control unit ⑦ completely upward.

N91.10-2316-31

- ▶ **To use the EASY-ENTRY/EXIT feature:** press button ⑧. The seat is lowered completely.
- ▶ Press the ⑧ button again. The seat returns to the previously set height.
- ▶ **To set to the rest position:** pull lever ⑨ upwards and hold it.
- ▶ Push the seat back as far as it will go.
- ▶ Also, pull lever ⑩ upward and slide the seat back beyond the detent into the rest position.
- ▶ Release levers ⑨ and ⑩. In setting the seat fore-and-aft adjustment, you can slide the seat forwards into the driving position again and engage it in place.
- ▶ **To fold the backrest:** pull lever ⑭ upward and fold the backrest forward or backward.

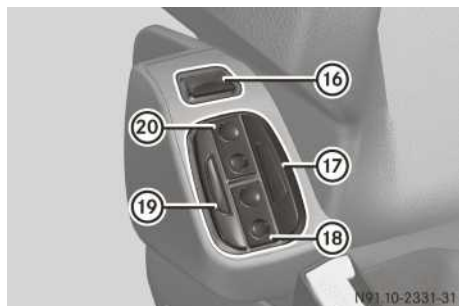

Example: control panel on the inner side, air-conditioned suspension seat with massage function

- ❗ With the massage function, you can prevent muscle tension.
- ▶ **To switch the massage function on/off:** press button ⑯. When the massage function is switched on, you will feel a wave motion alternating in direction, up and down, in the lumbar area of the backrest. The individual air cushions in the backrest will alternately fill, then empty again for approximately 10 minutes.
- ❗ You can adjust the backrest contour (lumbar support) and the side contours to support your spine.
- ▶ **To adjust the backrest contour:** press the upper or lower section of button ⑳. The upper seat backrest contour is increased or decreased.
- ▶ Press the upper or lower section of button ⑱. The lower seat backrest contour is increased or decreased.

- ▶ Press button ⑰. The side contour increases.
- ▶ Press button ⑲. The side contour decreases.

Function seat



Before adjusting the seat, read the important safety notes about the seats.

- ▶ **To adjust the armrests:** swing armrest ① upwards.
- ▶ Use the handwheel on the underside to set the angle of armrests ①.
- ▶ **To adjust the backrest:** relieve the backrest of any weight.
- ▶ Pull lever ③ up and hold it.
- ▶ Apply weight to or relieve the seat backrest of any weight in order to move it into the desired position.
- ▶ Release lever ③.
- ▶ **To fold up the seat cushion:** fold up seat cushion ② until it engages.
- ▶ **To fold down the seat cushion:** press seat cushion ② against the seat backrest to release it.
- ▶ Fold seat cushion ② down.

Beds in an L cab

Overview

The following beds may be fitted in the L cab:

- Upper bed, narrow (▷ page 77)
- Upper bed, wide (▷ page 77)
- Upper bed (car transporter with two beds) (▷ page 78)
- Foldable upper bed
- Lower bed (▷ page 78)
- Seat/berth combination (▷ page 79)
- SoloStar Concept (▷ page 81)

Upper bed

Climbing aids



Example: engine tunnel stowage compartment

Use the surface next to the cup holders or the stowage space on the engine tunnel as climbing aids for the upper bed.

Upper bed, wide/narrow

WARNING

A vehicle occupant on the bed while the vehicle is in motion cannot be restrained. There is a risk of serious or even fatal injuries.

Only use the bed when the vehicle is stationary.

- ! Make sure that the bed does not hit the seats when you fold it up or down. Swing or fold the backrests of the driver's and co-driver's seats forward or adjust the seats further forward. The bed can otherwise hit the seats and damage both components.

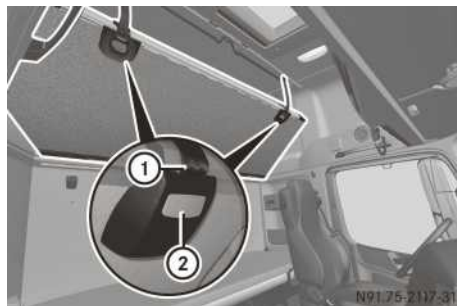

Example: upper bed, wide

If the vehicle is on an uphill or downhill gradient, the wide upper bed can be adjusted to a horizontal position. To do this, adjust the angle of the wide upper bed.

- ▶ Adjust or fold the driver's and co-driver seat backrests forward.
- ▶ If necessary, move the driver's and co-driver seats sufficiently forward.
- ▶ **To fold down and adjust the angle:** press and hold release button ②.

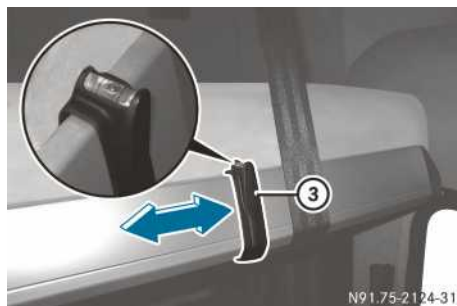

- ▶ Swing the bed downwards.
- ▶ Adjust the bed to the horizontal position using the tubular spirit level in bracket ③ and correct the angle. Move bracket ③ along the bed frame to fully align the bed. You can unclip bracket ③.

under the berth and re-clip it at the other end of the bed. The air bubble in the spirit level must always be between the lines.

- ▶ Release release button ②.
- ▶ Retaining straps ① engage automatically and the bed is held in position at that angle.
- ▶ **To fold up:** fold the bed up as far as it will go.

Upper bed (car transporter)

WARNING

A vehicle occupant on the bed while the vehicle is in motion cannot be restrained. There is a risk of serious or even fatal injuries.

Only use the bed when the vehicle is stationary.

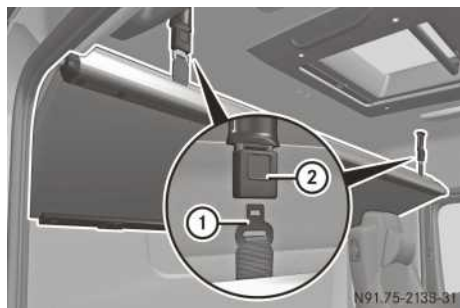

Example: upper bed

- ▶ Adjust or fold the driver's and co-driver seat backrests forward.
- ▶ If necessary, move the driver's and co-driver seats sufficiently forward.
- ▶ **To fold down:** lift the bed up slightly, hold it in place and press release buttons on both backrests ②.
- ▶ Pull out lower belt tongues ① using both retaining straps on belt buckles ②.
- ▶ Swing the bed downwards.
- ▶ **To fold up:** fold the bed up and hold it in place.
- ▶ Press belt tongues ① of the retaining straps into belt tongues ② until they engage audibly.

Lower bed

Lower bed

Folding the bed up/down

! Make sure that the bed does not hit the seats when you fold it up or down. Swing or fold the backrests of the driver's and co-driver's seats forward or adjust the seats further forward. The bed can otherwise hit the seats and damage both components.

! For safety reasons, fold the bed down before starting the journey. Otherwise, the rubber retainers may come loose from the wall brackets in the event of an accident. The bed folds down and may be damaged or may damage other components.

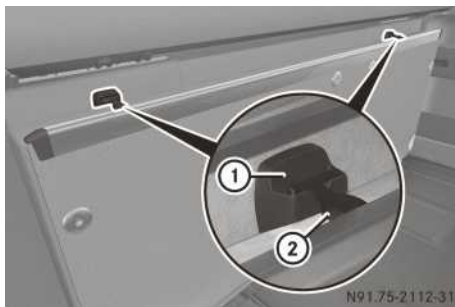

Example: lower bed

Folding up

- ▶ Adjust or fold the driver's and co-driver seat backrests forward.
- ▶ If necessary, move the driver's and co-driver seats sufficiently forward.
- ▶ Fully lower the adjustable backrest of the bed.
- ▶ Fold the bed up and press and hold it against the rear wall.
- ▶ Hook retaining bands ② into both wall brackets ①.

Folding down

- ▶ Press and hold the bed against the rear wall.
- ▶ Unhook rubber retainers ② from wall brackets ①.
- ▶ Swing the bed downwards.

Setting up the safety net

WARNING

A vehicle occupant cannot be restrained if the vehicle occupant is on the bed while the vehicle is in motion and the safety net has not been fitted. There is a risk of serious or even fatal injuries.

Always fit the safety net before a vehicle occupant uses the bed.

WARNING

If a vehicle occupant is on the berth, he or she can fall and become injured.

When staying on the berth, always use the safety net.

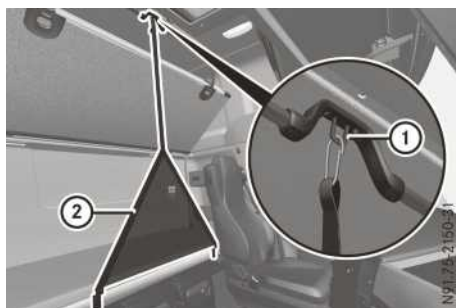

Example: lower bed with safety net

During your journey, only use the lower bed in conjunction with the safety net. Before using the bed, make sure you take notice of the legal requirements for the country you are currently in.

- ▶ Before starting the journey, hook safety net ② in loop ① on the cab roof.
- ❗ If the lower bed is unoccupied, stow the safety net under the bed. Attach the snap hooks to the appropriate loops on the left edge of the safety net.

Setting the adjustable backrest

Vehicles with lower bed, lowered have no adjustable backrest.

- ❗ Always leave the adjustable backrest in the horizontal position during the journey. If you fold up the adjustable backrest, swing the backrest of the seat forwards or move the seat forwards. Otherwise, the adjustable

backrest can hit the seat and damage both components.

When resetting the seat position, make sure that the adjustable backrest of the lower bed is lowered completely.

- ❗ Do not leave any objects under the folded up adjustable backrest. The adjustable backrest or the bed could otherwise be damaged when folded down.

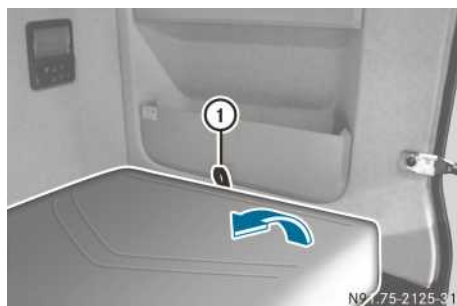

Place a maximum load of 500 N (50 kg) on the adjustable backrest.

- ▶ Pull up the adjustable backrest by loop ① and engage it in place. The adjustable backrest engages in 5 positions.
- ▶ To lower to the horizontal position, raise the adjustable backrest using loop ① beyond the uppermost position, then fully lower it.

Seat/berth combination

Important safety notes

WARNING

A vehicle occupant on the berth while the vehicle is in motion cannot be restrained. There is a risk of injury, possibly even fatal. Only use the berth when the vehicle is stationary.

WARNING

If a vehicle occupant is on the berth, he or she can fall and become injured. When staying on the berth, always use the safety net.

⚠ WARNING

If the seat cushion is not locked in the seat position, it could move. The seat belt cannot perform its intended protective function. There is an increased risk of serious or even fatal injuries.

Before beginning the journey, always make sure that the seat cushion is locked in the seat position.

⚠ WARNING

When folding the seat backrest up or down, you or other vehicle occupants could become trapped. There is a risk of injury.

Make sure that the seat backrest swinging range is not obstructed and that no one could become trapped.

⚠ WARNING

If you do not hold the seat backrest in place when folding it up or down, it will fall down. It could strike a vehicle occupant and cause body parts to become trapped. There is a risk of injury.

Always hold the seat backrest in place when folding it up or down.

⚠ WARNING

When pulling out the seat cushion, you or other vehicle occupants could become trapped between the seat frame and the seat cushion. There is a risk of injury.

When pulling out the seat cushion, make sure that no one is within the sweep range of the seat cushion.

The safety net on the uppermost berth is not a restraint system to allow use of the berth while the vehicle is in motion.

The seat/berth combination is not intended for child restraint systems. Only fit a child restraint system to the co-driver's seat. Observe the safety notes in the "Children in the vehicle" section (▷ page 54).

The seat backrest and/or seat cushion have an upright position and a fully reclined position.

Lower berth

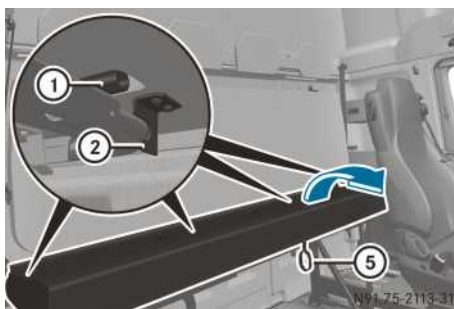

Example: seat/berth combination

- ▶ **To pull out the seat cushion to the fully reclined position:** pull the seat cushion up and forward by loop (5). Brackets (2) on the seat cushion are attached to detents (1).
- ▶ **To push in the seat cushion to the upright position:** lift the seat cushion by loop (5) and slide it back.

Upper berth

Folding the seat backrest up to the fully reclined position

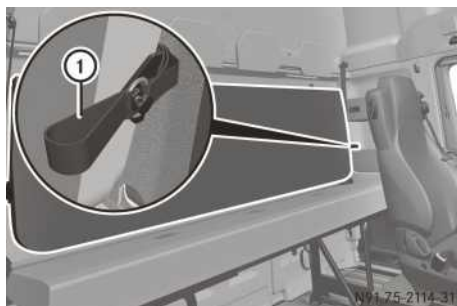

Example: left retainer belt

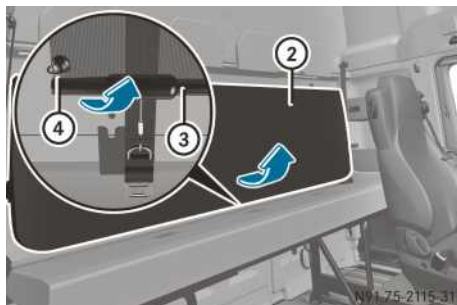

Example: safety net anchorage

- ▶ Unhook retainer belts ① on the right and left of backrest ②.
- ▶ Swing up backrest ②.
- ▶ On the rear of seat backrest ②, release safety net ③ from retaining pins ④ and from the press studs on the right and left.
- ▶ Swing backrest ② to the horizontal position and hold it there.

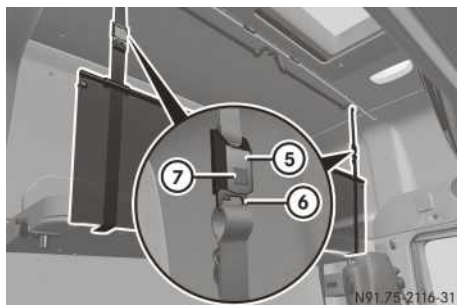

- ▶ Clip belt tongues ⑥ into seat belt buckles ⑤ on the right and left.

Folding the seat backrest down to the upright position

- ▶ Lift up backrest ② slightly, hold it in place and press release buttons ⑦ of buckles ⑤ on the left and right.
- ▶ Swing backrest ② slightly upwards.
- ▶ On the back of seat backrest ②, fasten safety net ③ to retaining pins ④ and to the right and left press studs.
- ▶ Swing the berth down to the rear panel.
- ▶ Hook retainer belts ① onto the right and left of backrest ②.

SoloStar Concept

Co-driver's seat and folding table

⚠ WARNING

If the folding table is folded out while the vehicle is in motion, vehicle occupants may bang into it, particularly in an accident, under sudden braking or during abrupt changes of direction. There is a risk of injury.

Fold up the folding table before every journey.

⚠ WARNING

If objects, luggage or loads are not secured or not secured sufficiently, they could slip, tip over or be flung around and thereby hit vehicle occupants. There is a risk of injury, especially when braking or abruptly changing directions. Always store objects so that they cannot be flung around. Secure objects, luggage or loads against slipping or tipping before the journey.

While the vehicle is in motion, store loose objects in the stowage spaces and stowage compartments (▷ page 107).



- ① Corner seat
- ② Folding table

- ▶ **To adjust the head restraint:** pull the head restraint up or push it down to the desired height.
- ▶ **To remove the head restraint:** pull the head restraint firmly up and out.

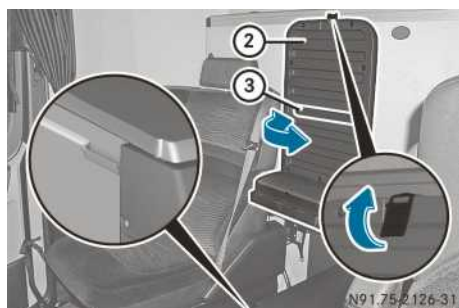

- ▶ **To fold down the folding table:** fold out supports ③ on folding table ② and engage.
- ▶ Unclip the retainer band from folding table ②.
- ▶ Fold down folding table ②. Support ③ is in the recess on the side trim panel of the drawers.
- ▶ **To fold up the folding table:** fold up folding table ② and attach the retainer band to folding table ②.
- ▶ Fold in support ③.

Folding the bed down/up

WARNING

A vehicle occupant on the bed while the vehicle is in motion cannot be restrained. There is a risk of serious or even fatal injuries.

Only use the bed when the vehicle is stationary.

- ❗ Make sure that the bed does not hit the seats when you fold it up or down. Swing or fold the backrests of the driver's and co-driver's seats forward or adjust the seats further forward. The bed can otherwise hit the seats and damage both components.

- ❗ Always leave the adjustable backrest in the horizontal position during the journey. If you fold up the adjustable backrest, swing the backrest of the seat forwards or move the seat forwards. Otherwise, the adjustable backrest can hit the seat and damage both components.

When resetting the seat position, make sure that the adjustable backrest of the lower bed is lowered completely.

- ❗ Do not leave any objects under the folded up adjustable backrest. The adjustable backrest or the bed could otherwise be damaged when folded down.



- ▶ If necessary, move the driver's seat sufficiently forward.
- ▶ Fold up folding table ②, attach the retainer band to folding table ② and fold in the support.
- ▶ Pull loop ③ on co-driver's seat ①. The co-driver seat backrest is unlocked.
- ▶ Fold down the backrest.

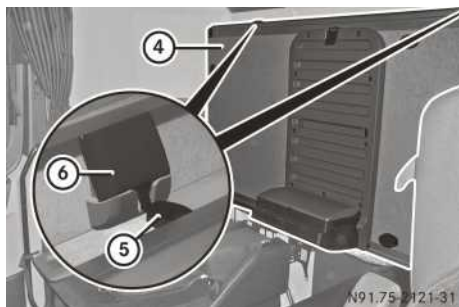

Before using the bed during a journey, make sure you take notice of the legal requirements for the country you are currently in. If you use the bed while the vehicle is in motion, tighten the safety net. Information on tightening the safety net and on setting the head section can be found in the "Lower bed" section (▷ page 78).

- ▶ **To fold down:** press bed ④ against the rear wall.
- ▶ Press and hold lock ⑥.
- ▶ Unclip retainer band ⑤ from the wall bracket.
- ▶ Release lock ⑥.
- ▶ Swing bed ④ downwards.
- ▶ **To fold up:** fully lower the head section of the bed.
- ▶ Fold up bed ④ and press against the rear wall.
- ▶ Press retainer band ⑤ towards lock ⑥ and clip it into the wall bracket.
- ▶ Fold back the seat backrest until it engages.

Berths in an M cab

Overview

The following berths may be fitted in the M cab:

- Standard berth, lower/padded stowage space (▷ page 83)
- Lower standard berth, split (▷ page 84)

Standard berth, lower/padded stowage space

⚠ WARNING

A vehicle occupant on the berth while the vehicle is in motion cannot be restrained. There is a risk of injury, possibly even fatal. Only use the berth when the vehicle is stationary.

- ! Make sure that the berth does not hit the seats when you fold it up or down. Swing or fold the backrests of the driver's and co-driver's seats forward or adjust the seats further forward. The berth can otherwise hit the seats and damage both components.

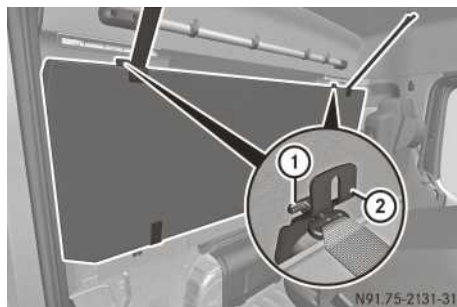

Berths (example: standard berth, lower)

- ▶ Vehicles with standard lower berth: adjust or fold the driver's and co-driver's seat backrests forward.
- ▶ If necessary, move the driver's and co-driver's seats sufficiently forward.
- ▶ **To fold down:** press and hold the berth against the rear wall.
- ▶ Turn hook ① 90° and unhook it from wall retainer ②.
- ▶ Fold the berth down.
- ▶ **To fold up:** fold up the berth and press and hold it against the rear wall.
- ▶ Turn hook ① 90° and hook it into wall retainer ②.

Lower standard berth, split

WARNING

A vehicle occupant on the berth while the vehicle is in motion cannot be restrained. There is a risk of injury, possibly even fatal.

Only use the berth when the vehicle is stationary.

-  Make sure that the berth does not hit the seats when you fold it up or down. Swing or fold the backrests of the driver's and co-driver's seats forward or adjust the seats further forward. The berth can otherwise hit the seats and damage both components.

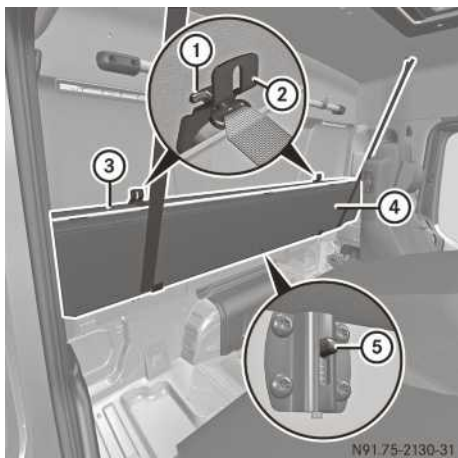

- ▶ Adjust or fold the driver's and co-driver's seat backrests forward.
- ▶ If necessary, move the driver's and co-driver's seats sufficiently forward.
- ▶ **To fold down:** press and hold the berth against the rear wall.
- ▶ Turn hook ① 90° and unhook it from wall bracket ②.
- ▶ Slide locking catch ⑤ down. Front ④ and rear ③ berth sections are no longer engaged.
- ▶ Fold the berth down.
- ▶ Press hooks ① between the upholstery.
- ▶ **To fold up:** fold up the berth and press and hold it against the rear wall.

- ▶ Turn hook ① 90° and hook it into wall bracket ②.
- ▶ Push front berth section ④ against rear berth section ③ until locking catch ⑤ engages.

Adjusting the multifunction steering wheel

WARNING

You could lose control of the vehicle while driving if you:

- adjust the driver's seat, steering wheel or mirrors
- fasten the seat belt

There is a risk of an accident.

Adjust the driver's seat, head restraint, steering wheel and mirrors and fasten your seat belt before starting the engine.

WARNING

The steering wheel may move unexpectedly if you adjust it while driving. This could cause you to lose control of the vehicle. There is a risk of an accident.

Make sure that the steering wheel is locked before driving off. Never unlock the steering wheel when the vehicle is in motion.



Unlocking the steering column in the driver's footwell

If sufficient supply pressure is available, you can adjust the steering wheel.

- ▶ Stop the vehicle.
- ▶ Apply the parking brake.

- ▶ **To adjust:** step on and hold down yellow button ①.
The steering column is unlocked.
- ▶ Adjust the multifunction steering wheel height and angle.
- ▶ Remove your foot from button ①.
The steering column is locked.

Adjusting the exterior mirrors

Important safety notes

WARNING

You could lose control of the vehicle while driving if you:

- adjust the driver's seat, steering wheel or mirrors
- fasten the seat belt

There is a risk of an accident.

Adjust the driver's seat, head restraint, steering wheel and mirrors and fasten your seat belt before starting the engine.

WARNING

The exterior mirrors reduce the size of the image. Objects visible in the mirrors are closer than they appear. You could misjudge the distance from road users driving behind you when changing lanes, for instance. There is a risk of an accident.

You should therefore always look over your shoulder to determine the actual distance from road users driving behind you.

An incorrectly adjusted exterior mirror may impair visibility. For this reason, always check the position of the exterior mirrors on the vehicle before starting a journey.



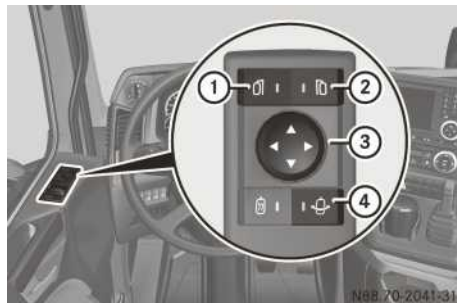



Adjusting the exterior mirrors



Driver's door control panel

- ① Left exterior mirror
- ② Right exterior mirror
- ③ Adjusting the exterior mirrors
- ④ Manoeuvring position for the exterior mirrors

Adjust the starting-off mirror, the kerb mirror and the wide-angle mirror by hand. In the manoeuvring position, the exterior mirror on the co-driver's side can move to allow you to monitor the trailer/semitrailer while manoeuvring. If the exterior mirror is in the manoeuvring position, you can adjust the exterior mirror horizontally.

- ▶ Switch the ignition lock to the drive position.
- ▶ **To adjust the exterior mirrors:** press the  button for the left exterior mirror or the  button for the right exterior mirror. The indicator lamp in the button lights up.
- ▶ Press the  button forwards or backwards, right or left, until the exterior mirror is correctly set.
- ▶ **To swing the exterior mirrors into the manoeuvring position:** press the  button. The indicator lamp in the button lights up. The exterior mirror on the co-driver's side moves outwards to the manoeuvring position.
- ▶ **To set the exterior mirrors to the manoeuvring position:** press the  button to the right or left until the exterior mirror is correctly set. The manoeuvring position is stored. When next manoeuvring, press the  button to

swing the exterior mirror into the previously set manoeuvring position.

- **To swing the exterior mirrors into the driving position:** press the  button.

The indicator lamp in the button goes out. The co-driver's exterior mirror swings back into the driving position you have set.

Exterior mirror heating

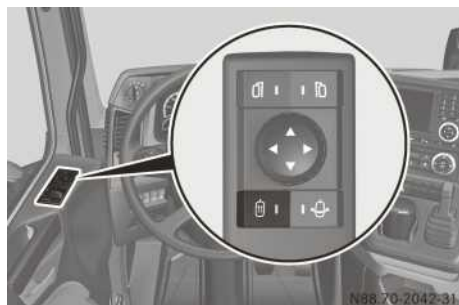

Driver's door control panel

In damp or cold weather, use the mirror heating to keep the exterior mirrors demisted and free of ice. The kerb mirror is not heated.

- Switch the ignition lock to the drive position.

- **To switch on/off:** press the  button. When the indicator lamp in the button lights up, the mirror heating is switched on.

- i** If the mirror heating is switched on and you swing the exterior mirrors into the manoeuvring position, the mirror heating will be deactivated. If you swing the exterior mirrors into the drive position again, the mirror heating will be reactivated.

Lighting system

Light switch

Important safety notes

WARNING

The rear exterior lighting is concealed when the tailgate is opened. This could cause other road users to fail to recognise the vehicle in time. There is a risk of an accident.



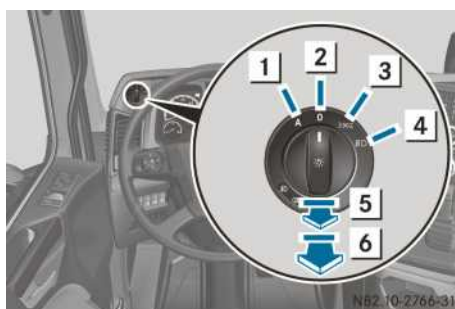

Make sure that the vehicle is safeguarded at the rear in accordance with national legal requirements, e.g. with a warning triangle.

Note that the auxiliary headlamps on the roof must not be switched on when driving on public roads.

Overview



Light switch



- | | |
|--|---|
| 1  | Automatic headlamp mode and daytime driving lights |
| 2 0 | Lights off/daytime driving lights |
| 3  | Side/rear lamps, licence plate lighting and perimeter/side marker lamps |
| 4  | Dipped-beam headlamps or main-beam headlamps |
| 5  | Foglamps |
| 6  | Rear foglamp |

The light switch can be used to switch the vehicle lighting on or off. The main-beam headlamps and the headlamp flasher are operated using the combination switch (> page 88).

A warning tone sounds if the driver's door is opened while:

- the dipped-beam headlamps are switched on and the ignition lock is in radio position
- the side lamps or dipped-beam headlamps are switched on and the ignition lock is in position **0**



Dipped-beam headlamps

- Turn the light switch to . The dipped-beam headlamps and side lamps are switched on. The  indicator lamp in the instrument cluster lights up.

- i** The dipped-beam headlamp beams are asymmetrical. For this reason, in countries

where vehicles drive on the opposite side of the road to the country where the vehicle is registered, there is a danger of oncoming traffic being dazzled. Mask the headlamps partially when driving in these countries (▷ page 100).

On vehicles with a manual headlamp range controller: the on-board computer shows the **Headl. range ctrl.** event window when the dipped-beam headlamps have been switched on for the first time after the engine has started. If the illumination of the road is insufficient or the oncoming traffic may be dazzled, change the setting shown.

- ▶ Change the setting with the  or  button.

When the vehicle is laden, the road should be illuminated from 40 m to 100 m and the dipped-beam headlamps must not dazzle oncoming vehicles. If the vehicle is unladen, select level .

Daytime driving lights

- ▶ Turn the key to the start position in the ignition lock.
- ▶ Turn the light switch to .

The daytime driving lights are switched on.

or

- ▶ Turn the light switch to .
- When the dipped-beam headlamps and side lamps are switched off automatically, the daytime driving lights come on.

The daytime driving lights switch off automatically when you turn the light switch to .



Automatic headlamp mode

WARNING

When the light switch is set to , the dipped-beam headlamps do not switch on automatically if there is fog, snow or other causes of poor visibility such as spray. There is a risk of an accident.

In such situations, turn the light switch to .

The automatic headlamp feature is only an aid. The driver is responsible for the vehicle lighting at all times.

When it is dark or foggy, turn the light switch from  to  in good time. The headlamps may otherwise be switched off temporarily.



- ▶ Switch the ignition lock to the drive position.
- ▶ Turn the light switch to .

The dipped-beam headlamps and side lamps are switched on or off automatically depending on light conditions. When the dipped-beam headlamps are switched on, the  indicator lamp in the instrument cluster lights up.

On vehicles with daytime driving lights: when the dipped-beam headlamps and side lamps are switched off automatically, the daytime driving lights come on.

- i** If the rain/light sensor is malfunctioning, the side lamps and dipped-beam headlamps are automatically switched on and remain on.



On vehicles with a manual headlamp range controller: the on-board computer shows the **Headl. range ctrl.** event window when the dipped-beam headlamps have been switched on for the first time after the engine has started. If the illumination of the road is insufficient or the oncoming traffic may be dazzled, change the setting shown.



- ▶ Change the setting with the  or  button.



For laden vehicles, the road should be illuminated from 40 m to 100 m and the dipped-beam headlamps must not dazzle oncoming vehicles. If the vehicle is unladen, select level .



- i** You can also adjust the headlamp range using the **Lighting** menu window in the  menu settings (▷ page 149).

Foglamps and rear foglamp

- ▶ Turn the light switch to the  or  position.

- ▶ **To switch on the foglamps:** pull the light switch out to position . The foglamps and the  foglamp indicator lamp next to the light switch light up.

- ▶ **To switch on the front and rear foglamps:** pull the light switch out to position . The front foglamps, rear foglamp and the  foglamp and  rear foglamp indicator lamps next to the light switch light up.

- i** If the vehicle only has a rear foglamp, turn the light switch to  and pull the light switch out to level .

Cornering lights

Vehicles with foglamps and LED daytime running lamps:

When the dipped-beam headlamps are switched on, the cornering lights improve the illumination of the road in the direction you are turning.

The cornering lights also assist you during manoeuvring. When you select reverse gear, both foglamps light up when the steering wheel is turned.

The cornering lights switch on automatically if:

- you are driving slower than 25 km/h and you indicate a turn or turn the multifunction steering wheel.
- you are driving between 25 and 40 km/h and turn the multifunction steering wheel.

The cornering lights may briefly remain lit, however they will be automatically switched off after approximately 3 seconds at the latest.

Combination switch

Main-beam headlamps/headlamp flasher



- Switch the ignition lock to the drive position.
- **To switch on the main-beam headlamps:** first switch on the  dipped-beam headlamps.



- Push the combination switch in the direction of arrow ② and engage. The  indicator lamp in the instrument cluster lights up.

- **To use the headlamp flasher:** briefly pull the combination switch in the direction of arrow ①. The  indicator lamp in the instrument cluster and the main-beam headlamps light up briefly.

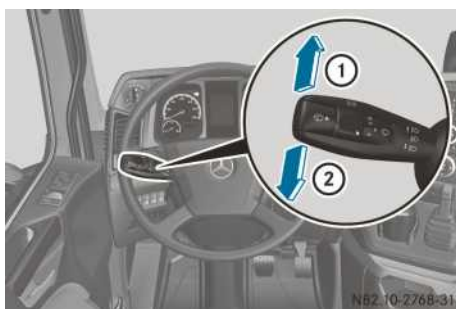
Turn signals







- **To indicate:** press and engage the combination switch upwards to indicate right ① or downwards to indicate left ②.

The appropriate turn signal lamps and the  or  indicator lamp in the instrument cluster flash.

The combination switch returns to its original position automatically after large steering movements.

- **To indicate briefly:** when overtaking or changing lane, press the combination switch briefly in the desired direction to indicate right ① or indicate left ②.

The appropriate turn signal lamps and the  or  indicator lamp in the instrument cluster flash 5 times.

- **To cancel brief indicating:** press the combination switch briefly in the opposite direction; indicate right ① or indicate left ②. The appropriate turn signal lamps and the  or  indicator lamp in the instrument cluster flash.

Interior lighting

Interior lighting switch

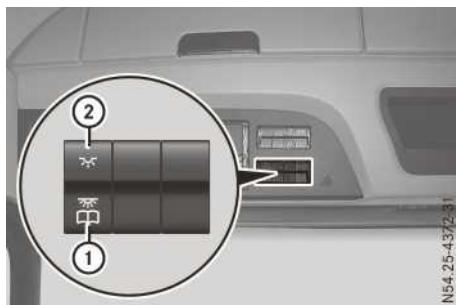

Switch panel above the windscreen (variant 1)



Switch panel above the windscreen (variant 2)

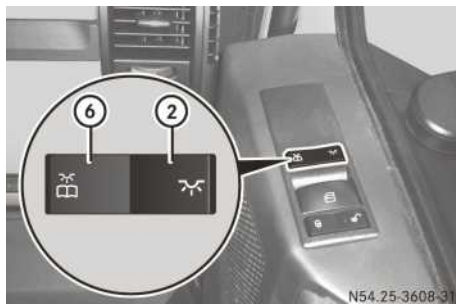

Switch panel, co-driver's door

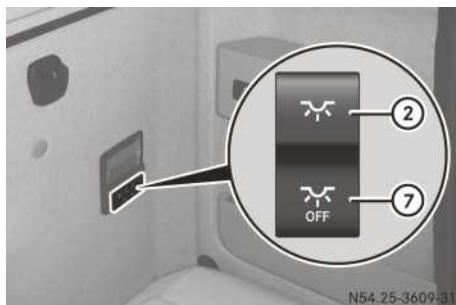

Switch panel, bed/berth with reading lamp (example: lower berth)

- ① To switch on/off or to dim the driver's reading lamp
- ② To switch on/off or to dim the interior light
- ③ To switch on/off or to dim the ambient light (blue)
- ④ To switch the automatic control of the interior lighting on/off
- ⑤ To switch the nightlight (green) on/off
- ⑥ To switch on/off or to dim the co-driver's reading lamp
- ⑦ To switch off all interior lights

Switching the interior lighting on/off

- **To switch the interior lighting on/off:** briefly press button ②. The interior lights are dimmed when switched on.
- **To dim:** press and hold button ②. The interior lighting brightness can be adjusted to between 0 and 100%. When the interior lighting reaches maximum brightness, it decreases again. When the interior lighting has been dimmed to the lowest limit, the brightness increases again. The brightness is automatically dimmed if you drive faster than 30 km/h.
- **To switch off the interior lighting:** press button ⑦ in the bed/berth switch panel. All interior lighting in the cab goes out.

Automatic control of the interior lighting

Depending on the equipment, switch the automatic control system of the interior lighting on/off:

- using the **Lighting** menu window in the  menu settings (▷ page 149)
 - using button ④ as described in the following
- **To switch on/off using the button:** press and hold button ④ until a short tone sounds. If you open the driver's or co-driver's door and the interior lighting and entry lighting are switched on automatically, the automatic control has been switched on.

There is a delayed switch-off of the interior lighting if you close the doors while the interior lighting automatic control is switched on.

The interior lighting switches off if:

- you start the engine with the doors closed
 - the last door open is closed while the engine is running
 - you lock the vehicle using the remote control
 - a door remains open for a longer period
- i** If you manually switch on the interior lights while the automatic control is switched on, the interior lights remain on until:
- you open/close a door (delayed shut-off)
 - you lock/unlock the vehicle using the remote control
 - you manually switch off the interior light

Switching the driver's/co-driver's reading lamp on/off

- **To switch on/off:** briefly press button ① for the driver's reading lamp or button ⑥ for the co-driver's reading lamp.

The corresponding reading lamp lights up.

- **To dim:** press and hold button ① for the driver's reading lamp or button ⑥ for the co-driver's reading lamp.

When the reading lamp reaches maximum brightness, the brightness decreases again. If the reading lamp has been dimmed to the maximum extent, the brightness increases again.

Switching the bed/berth reading lamp on/off

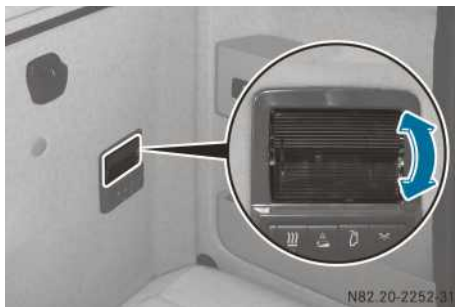

Bed/berth reading lamp (example: lower berth)

- **To switch on:** press the lower section of the reading lamp lens.
- **To switch off:** press the upper section of the reading lamp lens.

Switching the nightlight (green) on/off

The nightlight is used as non-dazzle courtesy lighting while driving.

Depending on the equipment, switch the automatic control system of the interior lighting on/off:

- using the **Lighting** menu window in the  menu settings (▷ page 149)
 - using button ⑤ as described in the following
- **To switch on/off using the button:** press button ⑤.

Switching the ambient lighting (blue) on/off

The ambient lighting provides interior lighting when the vehicle is parked.

- **To switch on/off:** briefly press button ③.

- **To dim:** press and hold button ③.

When the ambient lighting reaches maximum brightness, the brightness decreases again. If the ambient lighting has been dimmed to the maximum extent, the brightness increases again.

Illuminated Mercedes star





The illumination of the Mercedes star in the maintenance flap is only permitted if the vehicle is off public roads. Use on public roads is forbidden, including, for example, in public car parks.

In some countries, there may be deviations in the legal requirements pertaining to use of the illuminated Mercedes star as described here. Observe the legal requirements for the country you are currently in.

- ▶ **To switch on:** press the upper section of the  switch.

The indicator lamp in the  switch comes on.

- ▶ **To switch off:** press the lower section of the  switch.

The indicator lamp in the  switch goes out.

Rotating beacon



- ▶ **To switch on:** press the upper section of the  switch.

- ▶ **To switch off:** press the lower section of the  switch.

Observe the legal requirements for the country you are currently in when operating the vehicle with the rotating beacon. If the required field of vision is obscured by trailers, special bodies or other attachments, make the vehicle safe by using additional lights.

Roof position marker lamps



- ▶ **To activate:** press the upper section of the  button.

- ▶ **To deactivate:** press the upper section of the  button.

Observe the legal requirements for the country you are currently in when operating the vehicle with the position marker lamps.

Notes on replacing bulbs

WARNING

Bulbs, lamps and plug connectors can become very hot during use. When replacing a bulb, you could burn yourself on these components. There is a risk of injury.

Allow these components to cool down before replacing the bulb.

DANGER

Xenon bulbs are under high voltage. You can get an electric shock if you remove the cover of the xenon bulb and touch the electrical contacts. There is a risk of fatal injury.

Never touch the parts or the electrical contacts of the xenon bulb. Always have work on the xenon bulbs carried out at a qualified specialist workshop.

If your vehicle is equipped with bi-xenon bulbs, you can recognise this by the following: the cone of light from the xenon bulbs moves from the top to the bottom and back again when you start the engine. Dipped-beam headlamps must be switched on before the engine is switched on.

Bulbs and lamps are an important aspect of vehicle safety. You must therefore ensure that all bulbs are functioning at all times.

Mercedes-Benz recommends that if a dipped-beam headlamp or main-beam headlamp bulb fails, the corresponding bulb in the other headlamp should be replaced at the same time.

Mercedes-Benz recommends that you use Mercedes-Benz longlife bulbs for this purpose.

- To prevent a short circuit, switch the lighting system off and the ignition lock to position **0** before replacing a bulb.
- Wear eye protection and gloves when removing defective bulbs.
- Always replace defective bulbs with the specified new bulbs, i.e. those with the correct wattage and voltage.
- Only hold bulbs with a clean, lint-free cloth or a similar item. Do not work with wet or greasy fingers.
- Test the contacts for corrosion and clean them if necessary.
- Check that all seals are positioned correctly, and replace damaged seals.
- If the new bulb does not light up, consult a qualified specialist workshop.
- Have the following bulbs replaced at a qualified specialist workshop:
 - bi-xenon bulbs
 - navigation lights (bi-xenon headlamps)
 - LED daytime running lamp in the front foglamp
 - LED elements in the rear lamps
 - LED front perimeter lamp
 - ambient lighting bulbs in the cab

Replacing bulbs

Overview of bulbs

Front bulbs

Front turn signal lamps	PY 21 W24 V
Main-beam headlamps	H1 24 V
Daytime driving lights	H 21 W 24 V
Dipped-beam headlamps (halogen headlamps)	H7 24 V
Side turn signals, side marker lamps	P 21/5 W 24 V
Perimeter lamps	LED module
Foglamps	H11 24 V
Navigation lights (halogen headlamps)	W 5 W 24 V
Roof position marker lamps	R 10 W 24 V

Rear bulbs

Rear turn signal lamps, brake lamps, reversing lamp, rear foglamp	P 21 W 24 V
Rear lamps, licence plate lamp, position lamp	R 5 W 24 V

Interior lighting

Roof lamp: interior lighting	P 18 W24 V
Roof lamp: reading lamp	R 10 W24 V
Roof lamp: nightlight	EBS-R4 1.2 W24 V
Bed/berth reading lamp (festoon lamp)	10 W 24 V

Stowage compartment lighting under berth	W5W 5W 24 V
Stowage compartment lighting above windscreen (festoon lamp)	5 W 24 V

Additional bulbs

Side marker lamps	LED module
Upper working-area lamp	H11 24 V
Lower working-area lamp	H3 24 V
Rotating beacons	H1 24 V

Front bulbs

General information

Replacing bulbs is described for the headlamp on the right-hand side.

The following bulbs can be replaced:

- turn signal lamps
- main-beam headlamps
- daytime driving lights
- navigation lights (halogen headlamps)
- dipped-beam headlamps (halogen headlamps)
- side turn signals, side marker lamps
- foglamps
- roof position marker lamps

i Mercedes-Benz recommends that you have headlamp bulbs replaced at a qualified specialist workshop.

Swinging out the headlamps: variant 1



Cover next to headlamp (example: right-hand headlamp)

- ▶ Press the area marked with an arrow on the cover next to the headlamp. The cover opens.

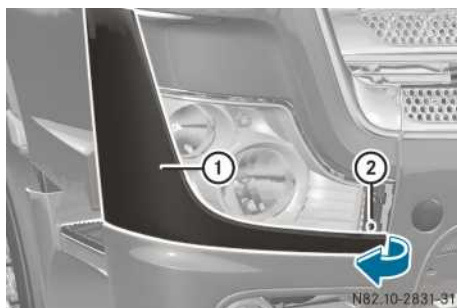

- ▶ Remove screw ②.
- ▶ Swing section of bumper ① outwards in the direction of the arrow.

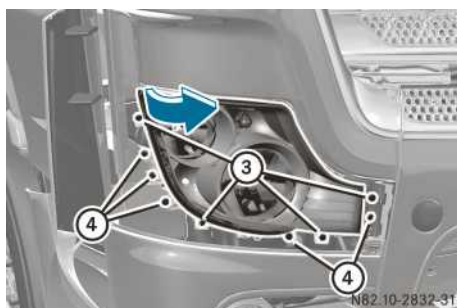

- ▶ Unscrew screws with grey washers ③. Do not turn headlamp adjustment screws ④. The headlamp must otherwise be readjusted.
- ▶ Swing the headlamp out in the direction of the arrow.

- ⓘ Do not rest on the headlamp when it has been swung out.

Swinging out the headlamps: variant 2

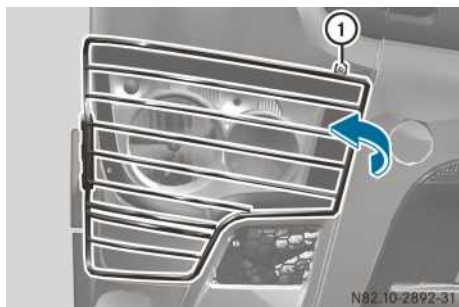

Protective grille (example: right-hand headlamp)

- ▶ If your vehicle is equipped with protective grids in front of the headlamps, loosen screw ① and swing the protective grid outwards in the direction of the arrow.

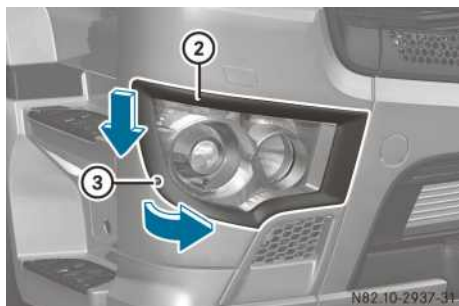

- ▶ Remove screw ③.
- ▶ Slide cover frame ② outwards and downwards, then swing it forwards in the direction of the arrow and remove it.

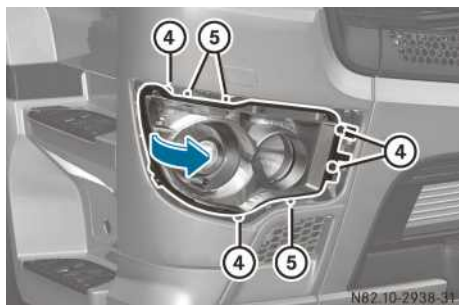

- ▶ Unscrew screws with grey washers ④.

Do not turn headlamp adjustment screws ⑤. The headlamp must otherwise be readjusted.

- ▶ Swing the headlamp out in the direction of the arrow.

- ⓘ Do not rest on the headlamp when it has been swung out.

Dipped-beam headlamps and navigation lights (halogen headlamps)

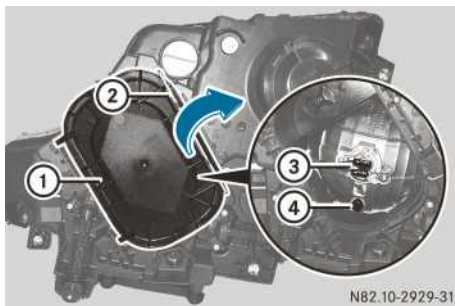

Halogen headlamps: variant 1

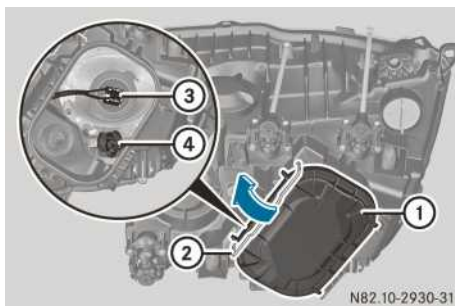

Halogen headlamps: variant 2

Observe the notes on replacing bulbs (▷ page 91).

- ▶ Swing out the headlamps – variant 1 (▷ page 93), variant 2 (▷ page 94).
- ▶ Press clip ② in the direction of the arrow.
- ▶ Open and remove cover ①.
- ▶ **Dipped-beam headlamp:** remove the connector from dipped-beam headlamp bulb ③.
- ▶ Unclip the retaining spring.
- ▶ Remove bulb ③.
- ▶ Insert the new bulb in such a way that its base fits into the recess of the bulb holder.
- ▶ **Navigation light:** press socket ④ to the side and pull it out.
- ▶ Pull the bulb out of the holder.

Main-beam headlamps

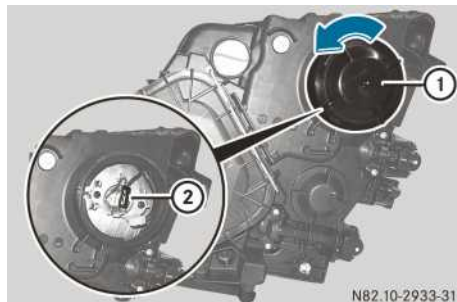

Headlamp, variant 1

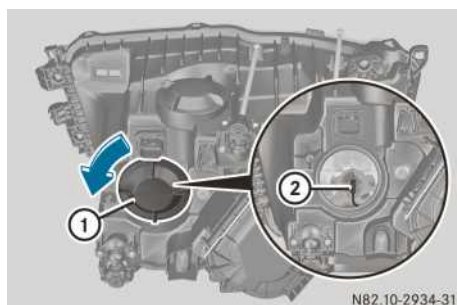

Headlamp, variant 2

Observe the notes on replacing bulbs (▷ page 91).

- ▶ Swing out the headlamps – variant 1 (▷ page 93), variant 2 (▷ page 94).
- ▶ Turn cover ① anti-clockwise and remove it.
- ▶ Pull the connector from bulb ②.
- ▶ Unclip the retaining spring.
- ▶ Remove bulb ②.
- ▶ Insert the new bulb in such a way that its base fits into the recess of the bulb holder.

Daytime driving lights

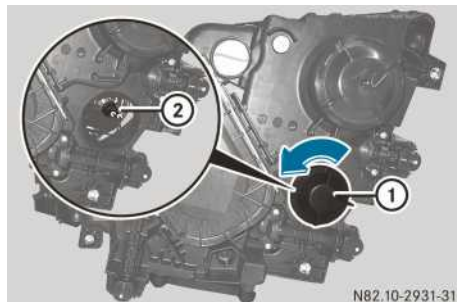

Headlamp, variant 1

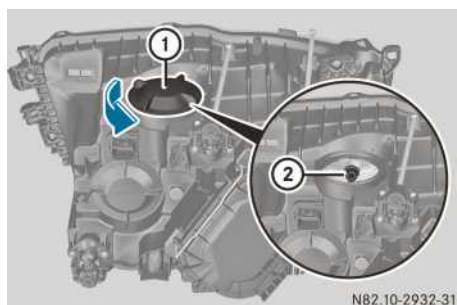

Headlamp, variant 2

Observe the notes on replacing bulbs (▷ page 91).

- ▶ Swing out the headlamps – variant 1 (▷ page 93), variant 2 (▷ page 94).
- ▶ Turn cover ① anti-clockwise and remove it.
- ▶ Turn bulb holder ② anti-clockwise, applying light pressure, and remove it.
- ▶ Turn the bulb anti-clockwise, applying light pressure, and remove it.
- ▶ Insert a new bulb into the bulb holder and turn it clockwise, applying light pressure.

Turn signal lamps

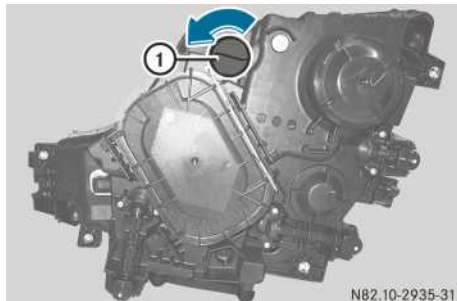

N82.10-2935-31

Headlamp, variant 1

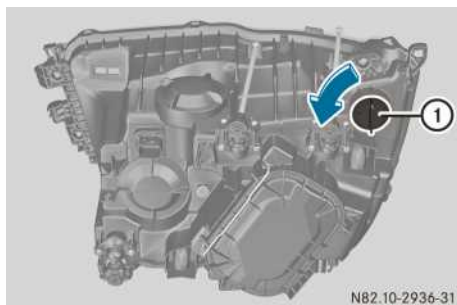

N82.10-2936-31

Headlamp, variant 2

Observe the notes on replacing bulbs
(▷ page 91).

- ▶ Swing out the headlamps – variant 1 (▷ page 93), variant 2 (▷ page 94).
- ▶ Turn holder ① anti-clockwise, applying light pressure, and remove it.
- ▶ Turn the bulb anti-clockwise, applying light pressure, and remove it.
- ▶ Insert a new bulb into holder ① and turn it clockwise, applying light pressure.

Side turn signals, side marker lamps

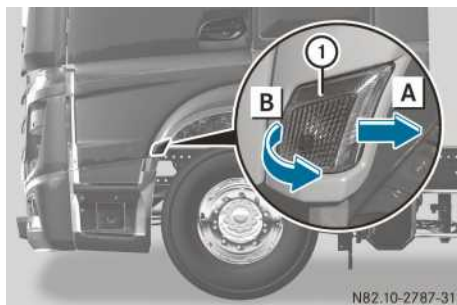

N82.10-2787-31

Observe the notes on replacing bulbs
(▷ page 91).

- ▶ Pull lamp ① back [A] and unclip at the front by turning [B].
- ▶ Turn the bulb holder anti-clockwise, applying light pressure, and remove it.
- ▶ Turn the bulb anti-clockwise, applying light pressure, and remove it.
- ▶ Insert a new bulb into the bulb holder and turn it clockwise, applying light pressure.

Foglamp: variant 1



N82.10-2779-31

Front foglamp (example: front foglamp with LED daytime running lamps, Actros)

If you remove front foglamp ① with LED daytime running lamp ⑤, do not replace the bulb for LED daytime running lamp ⑤. If necessary, have the light bulb replaced at a qualified specialist workshop.

Observe the notes on replacing bulbs
(▷ page 91).

- ▶ Remove screw ④ from faceplate ③.
- ▶ Unclip faceplate ③ at the top and bottom and remove it.
- ▶ Remove screws ② of front foglamp ① with LED daytime running lamp ⑤.
- ▶ Pull out front foglamp ① with LED daytime driving light ⑤ slightly.
- ▶ Remove the plug connector from the bulb of front fog lamp ① and LED daytime driving light ⑤.
- ▶ Pull out front foglamp ① with LED daytime running lamp ⑤.

- ▶ Unscrew the bulb from the reflector anti-clockwise.
- ▶ Insert the new bulb and turn it clockwise into the reflector.

Foglamp: variant 2



Front foglamp (example: front foglamp with LED daytime driving light, Antos)

If you remove the front foglamp with the LED daytime running lamp, do not replace the bulb for the LED daytime running lamp. If necessary, have the bulb replaced at a qualified specialist workshop.

Observe the notes on replacing bulbs (▷ page 91).

- ▶ Swing out the headlamp (▷ page 94).
- ▶ Remove the plug connector from bulb ① of the front foglamp.
- ▶ Unscrew bulb ① from the reflector anti-clockwise.
- ▶ Insert the new bulb and turn it clockwise into the reflector.

Roof position marker lamps

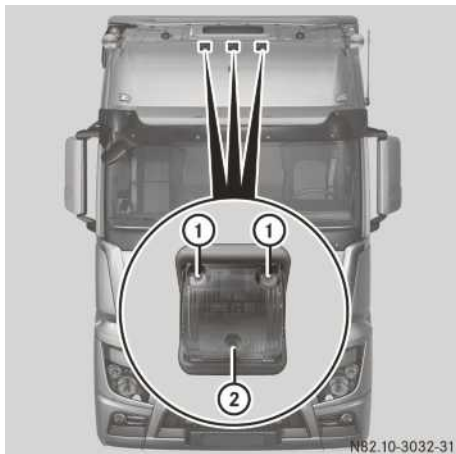

Roof position marker lamps

- ▶ Remove screws ①.
- ▶ Remove lamp lens ②.
- ▶ Turn the bulb anti-clockwise, applying light pressure, and remove it.
- ▶ Insert a new bulb into the bulb holder and turn it clockwise, applying light pressure.

Rear bulbs

Swinging away the protective grille

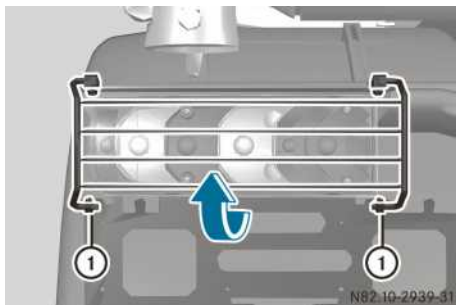

- ▶ Unclip the protective grille from clamp ① and swing it upwards.

Replacing bulbs

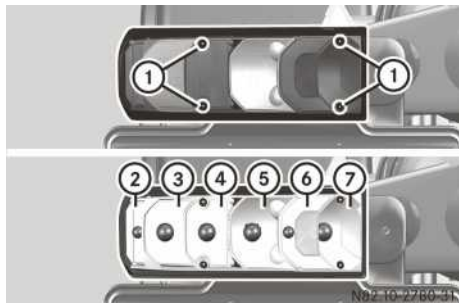

Six-chamber lamp cluster, rear left (example: platform truck)

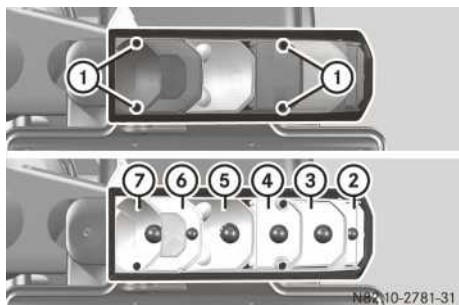

Six-chamber lamp cluster, rear right (example: platform truck)

- ① Bolts
- ② Perimeter/side marker lamps
- ③ Turn signal lamps
- ④ Brake lamp
- ⑤ Reversing lamp
- ⑥ Rear lamps
- ⑦ Rear foglamp

The licence plate lamp is behind the reflector unit.

If the vehicle lamp cluster unit has LED modules, do not replace the bulbs in the turn signals, tail lamps, brake lamps or perimeter lamps. If necessary, have these bulbs replaced at a qualified specialist workshop.

Observe the notes on replacing bulbs (> page 91).

- ▶ Remove bolts ①.
- ▶ Remove the lamp lens.

- ▶ Turn the bulb anti-clockwise, applying light pressure, and remove it.
- ▶ Insert the new bulb and turn clockwise, applying light pressure.

Interior lighting

Interior lighting/reading lamp

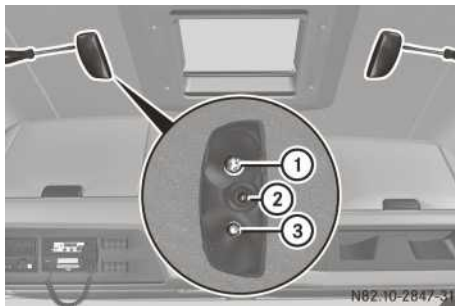

Observe the notes on replacing bulbs (> page 91).

- ▶ Prise off the lamp lens with a screwdriver.
- ▶ Interior lighting ①/nightlight ②/reading lamp ③: turn the bulb anti-clockwise, applying light pressure, and remove it.
- ▶ Insert the new bulb and turn clockwise, applying light pressure.

Reading lamp: bed/berth

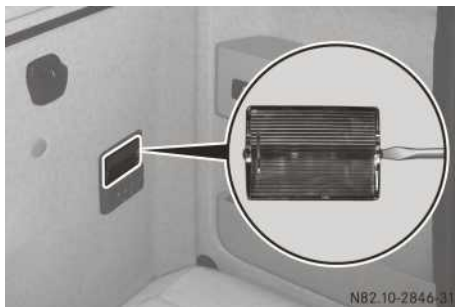

Reading lamp: bed/berth

Observe the notes on replacing bulbs (> page 91).

- ▶ Prise the lamp lens out of the pivot hinge using a screwdriver.
- ▶ Remove the bulb.
- ▶ Insert the new bulb.

Additional bulbs

Side marker lamps

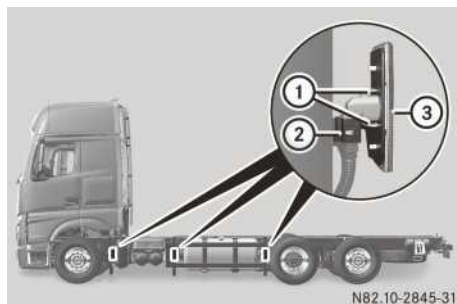

Side marker lamps (example: platform truck)

Observe the notes on replacing bulbs
(▷ page 91).

- ▶ Press the retainer on cable connector ② with a screwdriver and hold it.
- ▶ Disconnect cable connector ②.
- ▶ Press retainers ① on side marker lamp ③ together and hold in this position.
- ▶ Replace side marker lamp ③.

i Semitrailer tractor vehicle: swing the side panel out before replacing the side marker lamp (▷ page 336).

Upper working-area lamp



Example: semitrailer tractor vehicle, working-area lamp

Observe the notes on replacing bulbs
(▷ page 91).

- ▶ Press securing knobs ① and swing the housing upwards.



- ▶ Turn bulb ② with cable connector ③ upwards and remove it.
- ▶ Press the retainers on cable connector ③ together and hold in this position.
- ▶ Disconnect cable connector ③.
- ▶ Replace bulb ②.

Lower working-area lamp

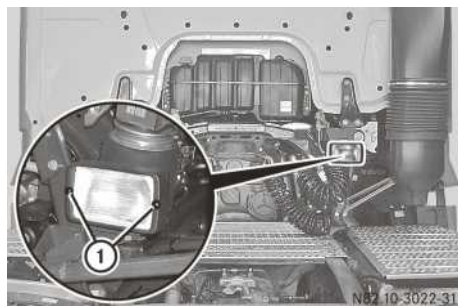

Example: semitrailer tractor vehicle, working-area lamp

Observe the notes on replacing bulbs
(▷ page 91).

- ▶ Loosen screws ①.
- ▶ Remove the reflector with the frame.

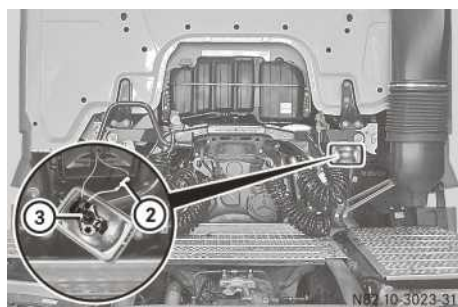

- ▶ Disconnect cable connector ②.
- ▶ Unclip the retaining spring.
- ▶ Remove bulb ③.
- ▶ Insert the new bulb in such a way that its base fits into the recess of the bulb holder.

Partially masking headlamps – driving on the left/right

! Do not use a sharp object to remove the sticker. Otherwise, you could damage the headlamp lens.

Mask the headlamps when driving in countries where vehicles drive on the opposite side of the road to the country where the vehicle is registered. This prevents oncoming traffic from being dazzled. Masked headlamps do not illuminate as large an area of the edge of the carriageway.

When using the vehicle in other countries observe the legal requirements for the country you are currently in.

The driver is responsible for the vehicle lighting at all times.

Have xenon headlamps switched over at a qualified specialist workshop as close to the border as possible before crossing into one of these countries. On your return journey, have the xenon headlamps switched back to asymmetrical dipped beam as close to the border as possible.

Halogen headlamps must be masked in accordance with the following Mercedes-Benz specifications as close to the border as possible before crossing into one of these countries. Use a commercially available opaque adhesive tape. On your return journey, remove the adhesive tape as close to the border as possible.

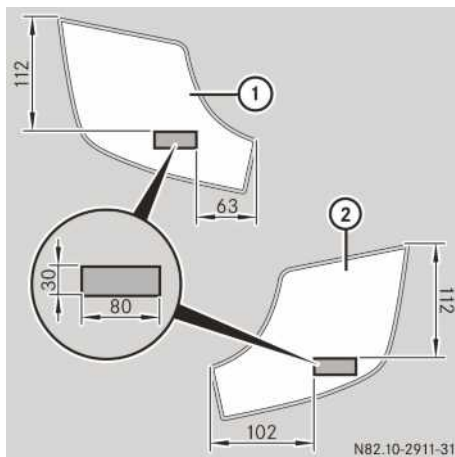

Headlamp masking surface for right-hand-drive vehicles for use in countries where vehicles drive on the left (example: halogen headlamp, version 1)

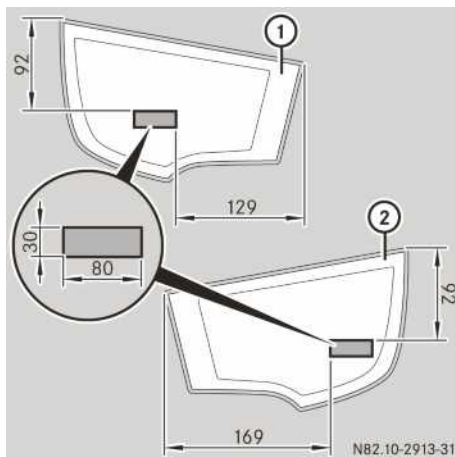

Headlamp masking surface for right-hand-drive vehicles for use in countries where vehicles drive on the left (example: halogen headlamp, version 2)

- ① Right headlamp
- ② Left headlamp

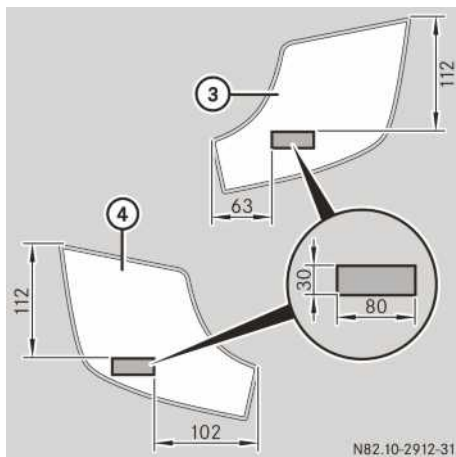

Headlamp masking surface for left-hand-drive vehicles for use in countries where vehicles drive on the right (example: halogen headlamp, version 1)

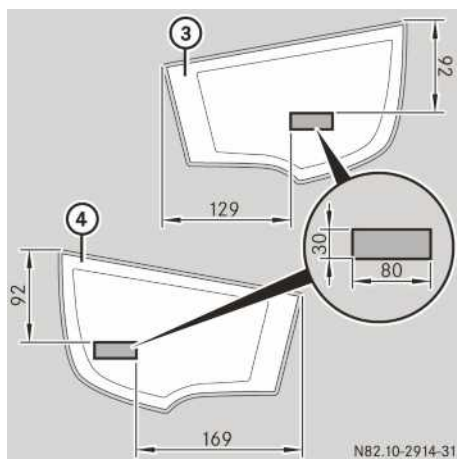

Headlamp masking surface for left-hand-drive vehicles for use in countries where vehicles drive on the right (example: halogen headlamp, version 2)

- ③ Left headlamp
- ④ Right headlamp

- ▶ Vehicles with halogen headlamps: make masking strips from commercially available opaque adhesive tape, cutting to the size and shape shown in the illustrations.
- ▶ Apply to the corresponding area of the headlamp.

Good visibility

Windscreen wipers

! Vehicles with rain/light sensor:

In dry weather conditions, switch the windscreen wipers off. Otherwise, dirt or optical effects may cause undesired windscreen wiper sweeps. This could then damage the windscreen wiper blades or scratch the windscreen.





! Switch off the windscreen wipers before you stop the engine. Otherwise, undesired wiper sweeps could occur when starting the next journey. This may damage the wiper blades or windscreen, especially if the windscreen is dirty or iced up.

Worn or damaged wiper blades result in smearing on the windscreen.

This can cause faults in vehicles with rain/light sensors.







Windscreen wiper switch in the combination switch

-  Windscreen wipers off
-  Slow intermittent wipe or wiping controlled by the rain sensor
-  Rapid intermittent wipe or wiping controlled by the rain sensor
-  Slow wipe
-  Rapid wipe

▶ **To switch on:** turn the ignition lock to the drive position.

▶ Turn the windscreen wiper switch to the appropriate setting depending on the intensity of the rain.



Vehicles with rain and light sensor: if the  or  setting is used, an appropriate wipe frequency is set according to rainfall. In the  position, the rain and light sensor is more

sensitive than in the  position, causing the windscreen wipers to wipe more frequently. If the rain and light sensor fails, the wiper automatically switches to the wiping interval corresponding to the position of the switch.

Windscreen washer system



Combination switch

- ▶ **Single wipe:** briefly press the  button.
- ▶ **To wipe the windscreen using washer fluid:** press and hold down the  button.

- i** Vehicles with headlamp cleaning system: After switching on the ignition, if you wash the windscreen with washer fluid with the dipped-beam headlamps switched on, the headlamps are also cleaned. If you wash the windscreen with washer fluid ten times with the dipped-beam headlamps switched on, the headlamps are also cleaned once.

Headlamp cleaning system

If you wash the windscreen with washer fluid for the first time with the dipped-beam headlamps switched on (> page 102), the relevant areas of the headlamps are also cleaned. If you wash the windscreen with washer fluid ten times with the dipped-beam headlamps switched on, the headlamps are also cleaned once.

Windscreen heating



The windscreen heating is operational when the engine is running and deactivates automatically after approximately 15 minutes.

- ▶ **To switch on/off:** press the upper section of the  button. If the indicator lamp in the switch lights up, the windscreen heating is activated.

Notes on winter driving

Headlamps

- !** If the plastic lenses or headlamps ice up in winter, do not remove the ice layer with an ice scraper. You could otherwise scratch the plastic covers. Only use de-icer spray that is suitable for plastic surfaces.

Windscreen washer system

At temperatures of approximately 5 °C to -5 °C with snowfall, direct the air to the windscreen using the  air-distribution control (> page 121). You can also switch on windscreen heating (> page 102). With these settings, the wiper blades on the front windscreen are heated. In this way you can prevent smearing or the snow freezing on the wiper blade.

Voltage supply

Battery isolator switch

WARNING

If the power supply is interrupted with the battery isolator switch, the engine is switched off automatically. Safety-relevant functions

may therefore be restricted or unavailable, e.g. power steering, lighting system and ABS. The compressed-air supply fails. To steer, you will require considerably more force. The wheels could lock during braking. Also, the spring-loaded parking brake can activate if there is a loss of compressed air and the vehicle may then brake uncontrollably. You could lose control of the vehicle. There is a risk of an accident.

Only use the battery isolator switch when the vehicle is stationary.

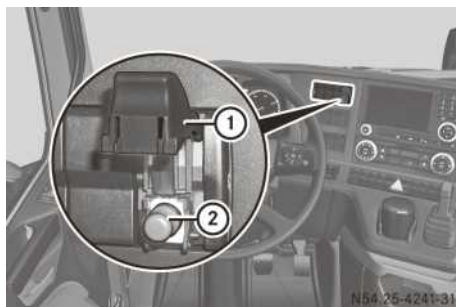

Example: battery isolator switch

You can interrupt the voltage supply using the battery isolator switches. This prevents short circuits, which could create sparks that might in turn cause a fire or an explosion. Vehicles for hazardous material transport are equipped with one or two battery isolator switches depending on the ADR classification regarding the interruption of the voltage supply.

When you have safely parked the vehicle, you can use the battery isolator switch, e.g. when loading the vehicle in a hazardous goods area. Only use the battery isolator switch when the vehicle is stationary. Observe the notes in the

event window in the on-board computer. Move the ignition lock to position **0** and remove the key from the ignition lock. On vehicles with a retarder, wait approximately 5 seconds after switching the ignition off before interrupting the voltage supply using the battery isolator switch. If the auxiliary heating is switched on, wait for the auxiliary heating run-on phase to end.

In a hazardous situation, the voltage supply can be interrupted using the battery isolator switches.

The disconnecting procedure up to the interruption of the voltage supply takes up to 10 seconds.

If the voltage supply is interrupted by the battery isolator switch when the anti-theft alarm system is primed, the anti-theft alarm is triggered.

Interrupting the voltage supply

- ▶ Swing the  cover ① upwards.
- ▶ Pull out switch pin ②.

or

- ▶ Move switch pin ③ upwards.
All consumers are disconnected from the batteries, apart from the digital tachograph.

Reconnecting the voltage supply

- ▶ Push the  cover ① down until it engages audibly.

Sockets

Overview



Example: power sockets on the dashboard

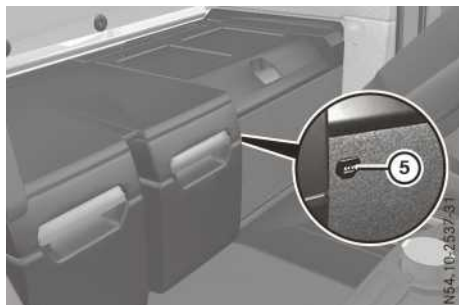

Example: power socket in the stowage compartment



Example: 24 V socket

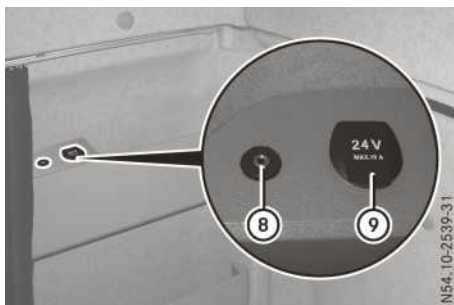

Example: power socket by the bed/berth

- ① Cigarette lighter 5 A (max. 120 W) or 24 V socket 15 A (max. 360 W)
- ② 24 V socket 15 A (max. 360 W), circuit 1
- ③ 24 V socket 15 A (max. 360 W), circuit 2
- ④ 24 V socket 15 A (360 W), circuit 2 or 12 V socket 15 A (180 W)
- ⑤ 24 V socket 15 A (max. 360 W), circuit 1
- ⑥ 24 V power socket 25 A (600 W)
- ⑦ Adapter plug 24 V power socket
- ⑧ AUX socket (see separate Operating Instructions)
- ⑨ 24 V socket 15 A (max. 360 W), circuit 2

12 V power sockets

Do not exceed a load of 180 W (15 A) for the 12 V sockets.

Vehicles with a 12 V connection point for auxiliary consumers: if you wish to use the 12-V socket, you must switch on the voltage transformer (▷ page 105).

24 V power sockets

You can use 24 V sockets as accessories up to 360 W (15 A) maximum.

The 24 V sockets are hooked up to two circuits:

- Circuit 1
24 V sockets ② and ⑤
- Circuit 2
24 V sockets ③, ④ and ⑨

If using several 24 V sockets simultaneously in one circuit, do not exceed the maximum load of 360 W (15 A).

Vehicles without a cigarette lighter: 24 V power socket ① is fitted in place of the cigarette lighter (▷ page 106). When the ignition lock is in the radio position or the key has been removed, the 24 V power socket is voltage safe.

► **To use the 24 V power socket:** switch the ignition lock to the drive position.

24 V power socket

You can always use 24 V power socket ⑥, irrespective of the use of other sockets, for accessories up to a maximum of 600 W (25 A). To use 24 V power socket ⑥ Mercedes-Benz recommends that you have adapter plug ⑦ fitted at a qualified specialist workshop. Otherwise, safe usage cannot be guaranteed.

Voltage transformer

Important safety notes

! The voltage transformer is intended for the operation of the following equipment only. Do not connect any other devices to the 12 V source.

If you wish to connect further devices, consult a qualified specialist workshop

12 V voltage transformer



Example: 12 V voltage transformer button

The voltage transformer supplies both the 12 V socket and the 12 V auxiliary consumers with a maximum of 15 A.

Vehicles with a 12 V connection point for auxiliary consumers:

- **To switch on/off:** press the 12 V button. When the indicator lamp in the 12 V button lights up, the 12 V sockets and the 12 V connection point for auxiliary consumers are supplied with voltage.

i The voltage transformer is supplied permanently on vehicles without the 12 V button.

Practical tips

Ashtray



Ashtray

You can insert both ashtrays with covers into any cupholder in the cab.

Cigarette lighter

WARNING

You can burn yourself if you touch the hot heating element or the socket of the cigarette lighter.

In addition, flammable materials can ignite if:

- the hot cigarette lighter falls
- a child holds the hot cigarette lighter to objects, for example

There is a risk of fire and injury.

Always hold the cigarette lighter by the knob. Always make sure that the cigarette lighter is out of reach of children. Never leave children unattended in the vehicle.



Cigarette lighter

Your attention must always be focused on the traffic conditions. Only use the cigarette lighter when road and traffic conditions permit.

- ▶ **To use the cigarette lighter:** switch the ignition lock to the drive position.
- ▶ Push the cigarette lighter in. When the heating element is glowing, the cigarette lighter moves back automatically.
- ▶ Pull the cigarette lighter out of the socket by its handle.

Depending on the equipment installed, a 24 V 15 A power socket can be found in place of the cigarette lighter (▷ page 104).

Smoke detector

General notes

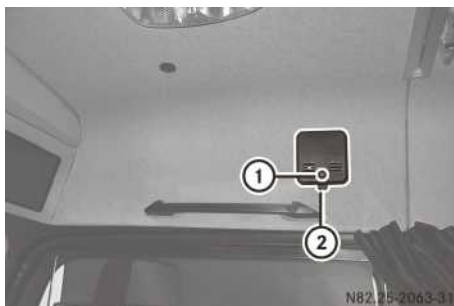

Example: smoke detector above the driver's door

- ① Button/indicator lamp
- ② Release catch

The smoke detector is located either above the co-driver's door or on the cabin ceiling behind the driver.

The smoke detector warns you of smoke in the cab. The alarm could also be triggered by particles, for example cigarette smoke, dust or exhaust fumes.

Switching off the alarm/temporarily deactivating the smoke detector

- ▶ Press button/indicator lamp ①. The smoke detector is deactivated for approximately 20 minutes and then automatically reactivated. A brief tone sounds approximately every 40 seconds while the smoke detector is deactivated and button/indicator lamp ① flashes every 10 seconds.

Smoke detector function test

WARNING

If the battery is discharged or the smoke detector is faulty, it is unable to issue you a warning. There is a risk of fatal injury.

Test the smoke detector regularly. Replace discharged batteries immediately.

Check the smoke detector for functionality once a week.

- ▶ Press and hold button ①.

If the smoke detector is working correctly, the alarm sounds. The smoke detector is deactivated for approximately 20 minutes after the button is pressed.

When the battery is discharged, a short tone will sound approximately every 40 seconds. Replace the battery as soon as possible in order to ensure that the smoke detector remains operational.

Replacing the battery

The smoke detector runs on a 9 V block battery.

- ▶ Press release catch ② and remove the smoke detector from the bracket.
- ▶ Replace the battery.
- ▶ Insert the smoke detector in the bracket.

Stowage spaces and compartments

Important safety notes

WARNING

If you transport objects in the vehicle interior and these are not adequately secured, they could slip or be flung around and thereby strike vehicle occupants. In addition, cup holders, open stowage spaces and mobile phone brackets may not always be able to hold the objects placed in them in the event of an accident. There is a risk of injury, particularly in the event of sharp braking or sudden changes of direction.

- Always stow objects in such a way that they cannot be tossed about in these or similar situations.
- Always make sure that objects do not project from stowage spaces, luggage nets or stowage nets.
- Ensure that closable stowage spaces are shut before beginning your journey.
- Always stow and secure heavy, hard, pointed, sharp-edged, fragile or outsize objects in the load compartment.

WARNING

If the maximum permissible load of the stowage compartment is exceeded, the cover cannot restrain the objects. Objects could be flung from the stowage compartment and hit vehicle occupants. There is a risk of injury, especially in the event of sudden braking or a sudden change in direction.

Always comply with the maximum permissible load of the stowage compartment.

WARNING

If the maximum permissible load of the stowage compartment is exceeded or the stowage compartment is not locked, the cover cannot restrain the objects. Objects could slip onto the road surface. There is a risk of an accident and injury.

Always comply with the maximum permissible load of the stowage compartment. Before starting the journey, make sure that the stowage compartment is locked.

Do not exceed the following weights for the individual stowage compartments or drawers:

- above the windscreen with cover: 8 kg
- cockpit stowage compartments or drawers: 10 kg
- central stowage compartments or drawers under the berth: 25 kg
- outer stowage compartments or drawers under the berth: 50 kg (including tools and equipment)

Stowage compartments above the windscreen

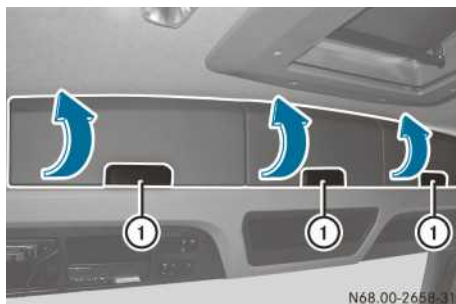

- ▶ **To open:** pull handle ① and swing the lid upwards.
The stowage compartment lighting comes on automatically.
- ▶ **To close:** swing the lid downwards and engage it in the lock.
The stowage compartment lighting switches off automatically.

Stowage compartments at the driver's workstation



- ▶ **To open:** pull out the drawers by the handle as far as they will go.
- ▶ **To close:** push in the drawers by the handle as far as they will go.



Small items and spectacles holder in the drawer (example: insert on the right)

You can remove the holder and attach it to the left or right side of the drawer or to another drawer.

Drawer/coolbox under the berth

Drawer

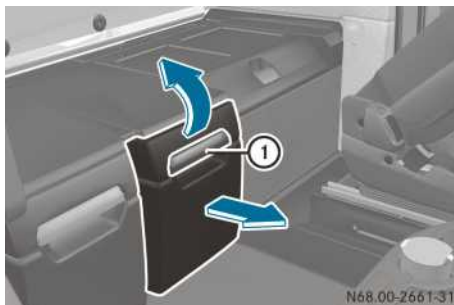

- ▶ **To open/close:** pull handle ① upwards and pull out or push in the drawer as far as it will go.

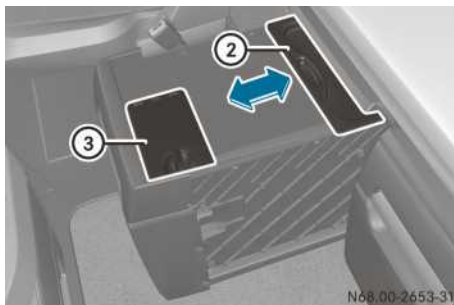

- ② Stowage tray
- ③ Waste container

- ▶ **To open/close:** pull out or push in stowage tray ② in the desired direction as far as it will go.

Waste container

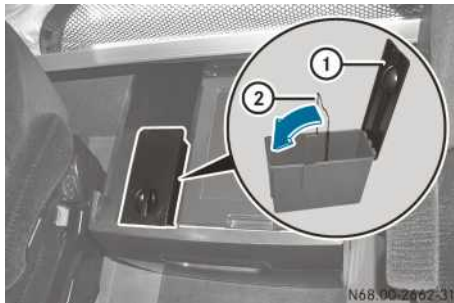

- ① Cap
- ② Handle

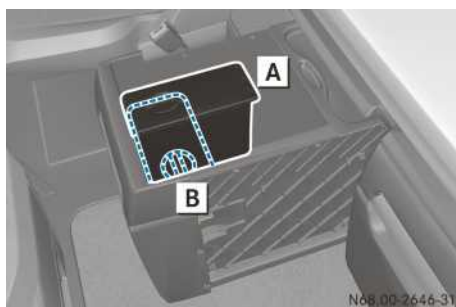

Installation position of the waste container

Place the waste container in position **A** or **B** only. Otherwise, the waste container is not secure and could fall over during the journey.

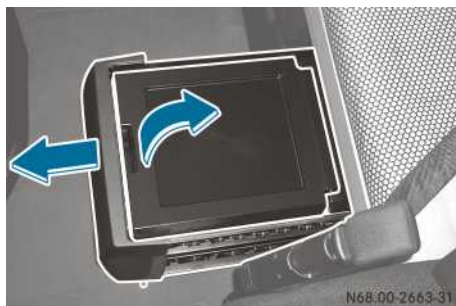

Coolbox



The drawer under the berth may also be equipped with a coolbox. Notes on the operation and settings for the coolbox can be found in the separate operating instructions.

- ▶ **To open:** pull out the drawer in the direction of the arrow as far as it will go.
- ▶ Using the handle, swing the lid upwards in the direction of the arrow and engage.
- ▶ **To close:** use the handle to swing the lid down.
- ▶ Push the drawer in as far as it will go.



- ▶ **To switch on:** press the upper section of the  switch. The indicator lamp in the switch comes on.
- ▶ **To switch off:** press the lower section of the  switch. The indicator lamp in the switch goes off.

Stowage compartments with exterior flaps

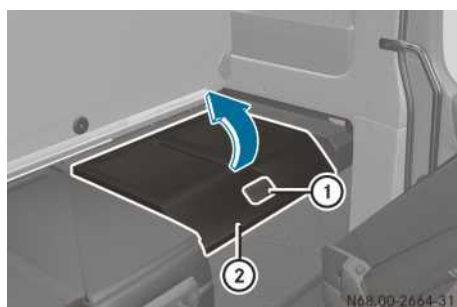

The stowage compartments can be accessed from the inside via the stowage compartment flaps beneath the berth and from the outside via the exterior flaps.

- ▶ Fold up and secure the lower berth.
- ▶ **To open the stowage compartment flap:** pull handle **1** and swing stowage compartment flap **2** upwards and engage it. The stowage compartment lighting comes on automatically.
- ▶ **To close the stowage compartment flap:** swing cover **2** downwards and engage it in the lock. The stowage compartment lighting switches off automatically.

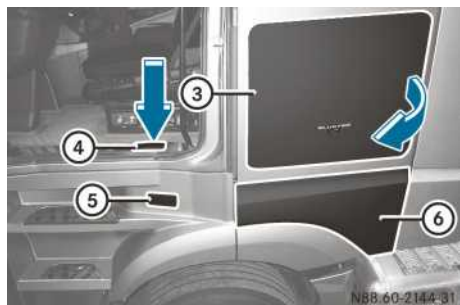

- ③ Stowage compartment exterior flap
- ④ Release lever for the stowage compartment exterior flap
- ⑤ Release lever for the tool kit compartment exterior flap
- ⑥ Tool kit compartment exterior flap
(▶ page 369)

- ▶ **To open the exterior flap:** press release lever ④ on the outside. Exterior flap ③ opens until stopped by the retaining hook.
- ▶ Press release lever ④ again on the outside. Stowage compartment exterior flap ③ is fully unlocked. The stowage compartment lighting comes on automatically.
- ▶ Swing stowage compartment exterior flap ③ forwards.
- ▶ **To close the exterior flap:** close stowage compartment exterior flap ③ so that it engages audibly in the lock. The stowage compartment lighting switches off automatically.

Folding table

⚠ WARNING

If the folding table is folded out while the vehicle is in motion, vehicle occupants may bang into it, particularly in an accident, under sudden braking or during abrupt changes of direction. There is a risk of injury.

Fold up the folding table before every journey.

⚠ WARNING

If you exceed the maximum permissible load of the folding table, the table panel folds down abruptly. There is a risk of injury.

Always comply with the maximum permissible load of the folding table.

Do not place more than 15 kg on the folding table.

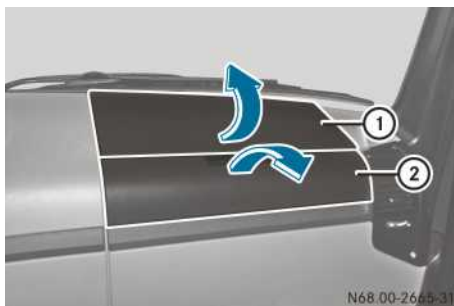

Folding out the folding table

- ▶ Fold lower cover ② down.
- ▶ Fold upper cover ① upwards and hold it in place.

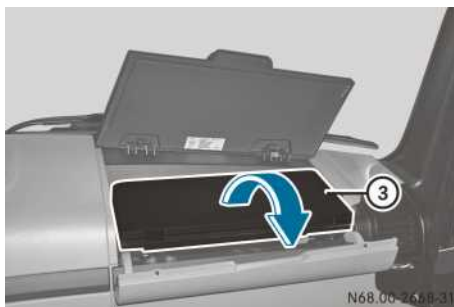

- ▶ Swing out folded folding table ③ as far as it will go.

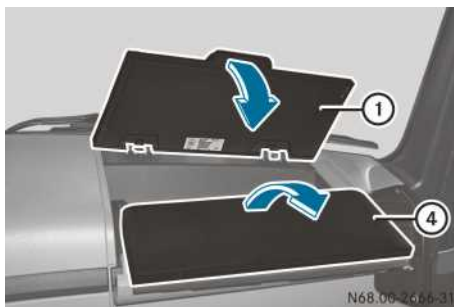

- ▶ Fold upper cover ① down.
- ▶ Fold out folding table half ④.



Folding table on the co-driver's side

Folding in the folding table

- ▶ Fold folding table half ④ forward.
- ▶ Fold upper cover ① upwards and hold it in place.
- ▶ Swing folded folding table ③ forward as far as it will go into the stowage compartment.
- ▶ Fold upper cover ① down.
- ▶ Fold lower cover ② upwards.



Cup holder

WARNING

Cup and bottle holders cannot hold liquid containers securely in place while you drive. If you use cup or bottle holders while driving, containers could be flung around and liquids could be spilled. Vehicle occupants may come into contact with the liquid and, particularly, if it is hot, they could be scalded. You could be distracted from traffic conditions and you may lose control of the vehicle. There is a risk of an accident and injury.

Only use cup and bottle holders if the vehicle is stationary. Only place suitable liquid containers in cup or bottle holders. Always close containers, particularly if they contain hot liquid.

Door (example: left side of the vehicle)

- ① Cup holder
- ② Bottle holder

Cup holders ① can also accommodate ashtrays (> page 105).

Compressed-air connection in the cab

WARNING

If you clean the cab with compressed air, particles are dispersed. These can enter or irritate the eyes, nose, mouth and ears. There is a risk of injury.

While cleaning the cab with compressed air, always wear a dust protection mask, protective eyewear and ear protectors.

WARNING

The compressed-air connection in the cab is under high pressure. If you aim the compressed-air pistol towards body parts or other people, eyes, ears or skin could be damaged. There is a risk of injury.

Always hold the compressed-air pistol away from your body. Never aim the compressed-air pistol towards other people.

- ❗ Do not clean the air filter with the compressed-air pistol. Replace soiled air filters.

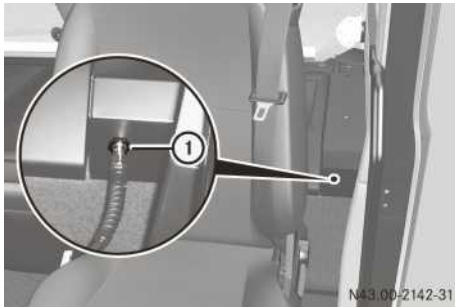

- ▶ **To attach:** push the compressed-air hose into compressed-air connection ① until it engages.
- ▶ **To disconnect:** push the compressed-air hose into compressed-air connection ① and remove it.

Communications

"Remote Online" function

General notes

With the "Remote Online" function, you can access the vehicle's network (Wi-Fi) from a distance of approximately 25 m with a mobile device. The distance is heavily dependant on the surroundings. The range is furthest in the open air and with direct visual contact. You can use various functions of the on-board computer and other additional functions over the vehicle's network.

For access to the vehicle's network:

- the Truck-App must be installed on the mobile device
- the mobile device must first be authorised to access the vehicle's network (▷ page 142)

Truck-App

The Truck-App can be purchased in the Google Play Store and in the Apple App Store and allows you to access the vehicle's network (Wi-Fi). You can operate various vehicle functions and call up status indicators with the Truck-App. The number of functions depends on the vehicle's equipment and the type of vehicle.

In the **Pairing** main menu, you can connect to a vehicle for which you have already received authorisation or add a new vehicle.

The vehicle functions in the **My Truck** main menu are distributed across the three menus Dashboard, Truck and Remote.

Some of the functions can only be operated when the ignition is switched on or the engine is running. In this case, use the ignition run-on (▷ page 239) or engine run-on (▷ page 239) functions.

Dashboard displays:

- total distance recorder and engine operating hours
 - levels of fuel and AdBlue®
- Further information on fuel/AdBlue® levels and range can be found in the "On-board computer and displays" section (▷ page 138).
- outside temperature and interior temperature (vehicles with automatic climate control)
 - reservoir pressure in the brake circuits

Truck:

- status indicators for the exterior flaps, the sliding sunroof/pop-up roof and the doors
- You can see whether the exterior flaps, the sliding sunroof/pop-up roof and the doors are open or closed and whether the vehicle is locked or unlocked.
- If necessary, you can open or close the sliding sunroof/pop-up roof.
- display of the axle loads and the gross weight, if:
 - the vehicle is stationary
 - the driving level is active
 - the ignition lock is in driving position, ignition run-on function (▷ page 239)

Refer to the "On-board computer and display" section (▷ page 145) for further information.

- tyre pressure, tyre temperature and battery status of the tyre pressure sensors

Refer to the "On-board computer and displays" section (▷ page 144) for further information on the tyre pressure monitor.

- controls for the level control as with the on-board computer if the ignition lock is in driving position (ignition run-on (▷ page 239) or engine run-on (▷ page 239)).

Refer to the "On-board computer and display" section (▷ page 145) for further information.

- bulb check

Dipped-beam headlamps, marker lamps, tail lamps and licence plate lighting light up permanently. Turn signals, main-beam headlamps, brake lights, daytime driving lights, reversing lamps, foglamps and working-area lamps are switched on one after the other. This cycle is repeated three times.

The bulb check can only be activated when the parking brake is applied.

Remote – remote control of:

- loading tailgate – unlocking and locking
Refer to the body manufacturer's operating instructions for further information.
- working area lamp – switching on or off
- auxiliary heating – switching on or off (▷ page 125)
- auxiliary air conditioning system – switching on or off (▷ page 123)
- interior lighting – switching the interior lighting, the nightlight and ambient lighting on or off (▷ page 149)
- audio system
 - switching on/off
 - source selection
 - station/track selection
 - volume adjustment
 - mute

Operating the audio system (radio)

General notes

If you have fitted Mercedes-Benz audio equipment, you can operate your audio equipment:

- using the buttons on the multifunction steering wheel, the **Audio** menu window in the  audio and communications menu of the on-board computer (▷ page 142)
- using the multifunction key (▷ page 57)

- using the Truck-App with a mobile device (▷ page 112)
- using the audio equipment button in the bed/berth switch panel

If you fit audio equipment from another manufacturer, you cannot use these functions.





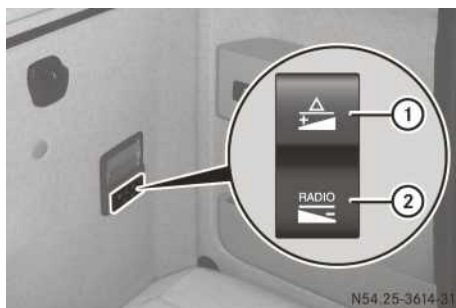

Information on operating your audio equipment can be found in the "Audio systems" section (▷ page 216).

Using the audio equipment button



Audio equipment button (example: lower berth)

- ① To switch the audio equipment on, to increase the volume, to select the next radio station, to select the next track
- ② To switch the audio equipment on/off, to decrease the volume

- ▶ **To switch on:** briefly press the  or  button.
- ▶ **To switch off:** press and hold the lower section of the  button.
- ▶ **To increase the volume:** briefly press the upper section of the  button.
- ▶ **To decrease the volume:** briefly press the lower section of the  button.
- ▶ **To select the next station/track:** press and hold the upper section of the  button.

Telephone

Important safety notes

WARNING



Operating the integrated information systems and communications equipment in the vehicle while driving will distract you from traffic con-

ditions. You could then lose control of the vehicle. There is a risk of an accident.

Only operate these devices if road traffic conditions permit. If you are unsure about the surrounding conditions, pull over to a safe location and make entries only while the vehicle is stationary.

Observe the legal requirements for the country you are currently in while operating the telephone or other communications equipment.

The vehicle can be equipped with a Bluetooth® hands-free system. To charge the Bluetooth® mobile phone in the vehicle, you need a suitable charger bracket. These are available from retailers of Mercedes-Benz accessories.

You can operate the mobile phone using the  and  buttons on the multifunction steering wheel (▷ page 141).

The Mercedes-Benz installation specifications must be observed if you subsequently install one of the following communication devices:

- mobile phone
- two-way radio
- fax machine

Connecting the mobile phone to the hands-free system



Hands-free system bracket holder

- ▶ Attach the mobile phone bracket to the bracket holder for the hands-free system.

i Detailed operating instructions can be found in the operating instructions for the mobile phone equipment. This is supplied with the mobile phone bracket.

Laptop holder

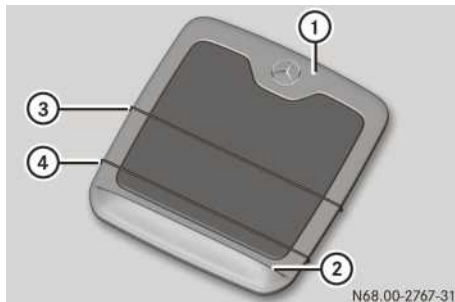

Front

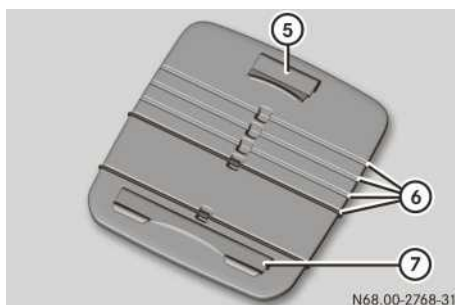

Back

You can also use laptop holder ① as a writing support.

Only use laptop holder ① when the vehicle is stationary. Stow laptop holder ① in a stowage compartment while driving.

- ▶ **To secure the laptop:** place laptop holder ① on the steering wheel and hang it on the steering wheel using upper clip ⑤.
- ▶ Open the laptop and push the keyboard base of the laptop under rubber bands ③ and ④ all the way to edge ② of laptop holder ①.
- ▶ If necessary, move rubber band ③ so that it does not impede your use of the keyboard. To do this, the rubber band must be pulled into one of the grooves ⑥.

If, during a rest period, you wish to use your laptop solely as a playback device, you can position it on the laptop holder within the driver's cabin in the following ways:

- ▶ Using upper clip ⑤, hook the laptop holder into an open space above the windscreen.

or

- ▶ Using upper clip ⑤, hook the laptop holder onto a grab handle on the upper part of the doors.

or

- ▶ Using upper clip ⑤ and lower clip ⑦, hook the laptop into the sidewall stowage compartment of the lower bed or lower berth.

Useful information

These Operating Instructions describe all the models and standard and optional equipment of your vehicle that were available at the time of going to print. Country-specific differences are possible. Bear in mind that your vehicle may not be equipped with all the functions described. This also applies to safety-relevant systems and functions.

Read the information on qualified specialist workshops (▷ page 31).

General notes

Environmental note

Only switch on the cooling with air dehumidification function for air conditioning or automatic climate control when necessary. Fuel consumption increases when the function is switched on.

The heating/air-conditioning system/automatic climate control can only be operated when the engine is running.

In order to ensure optimum functioning, close:

- the windows
- the sliding sunroof
- the pop-up roof
- the roof hatch

The air-conditioning system/automatic climate control regulates the temperature and humidity of the cab and filters out undesirable substances from the air.

The integrated filter largely filters out dust particles, pollen and unpleasant odours from the air drawn in from outside or recirculated air in recirculation mode. A blocked filter reduces the amount of air supplied to the cab.

Depending on the operating conditions and environmental influences, the interval for replacing the filter may be shorter than specified.





- i** Ventilate the vehicle for a brief period during warm weather. This will speed up the cooling process and the desired interior temperature will be reached more quickly.

Overview of climate control system functions

Heating



NB3.20-2287-31

-  Sets the airflow (▷ page 121)
-  Switches residual engine heat utilisation on/off (▷ page 122)
- Sets temperature (▷ page 120),
 demists windscreen
-  Switches air recirculation mode on/off (▷ page 122)
- Sets air distribution (▷ page 121),
 demists windscreen

The heating system is a heating and ventilation system without a cooling system.

Recommendations for optimal climate control:

- Slide the temperature control to the centre position. Only change the temperature in small increments.
- Heating with residual engine heat utilisation: to heat the stationary vehicle, use the residual heat of the engine after long journeys. The indicator lamp in the **REST** button lights up.
- Only use demisting mode until the misted windscreen is clear again (▷ page 121).
- Only use air-recirculation mode briefly, e.g. if there are unpleasant odours or in dusty conditions. The windscreen and the window may otherwise mist up as the flow of fresh air is deactivated and the air inside the vehicle is circulated.

Air-conditioning system



- ① Sets the airflow (▷ page 121)
- ② Switches the cooling or cooling with air dehumidification function on/off (▷ page 118), switches residual engine heat utilisation on/off (▷ page 122)
- ③ Sets temperature (▷ page 120), demists windscreen
- ④ Switches air recirculation mode on/off (▷ page 122)
- ⑤ Sets air distribution (▷ page 121), demists windscreen

The air-conditioning system is a combination of a heating and ventilation system and a cooling system.

Recommendations for optimal climate control:

- Set the temperature to 22 °C. Only change the temperature in small increments.
- Switch cooling or cooling with air dehumidification on. The indicator lamp in the or button lights up.
- Air-conditioning system with residual engine heat utilisation: after long journeys, use the residual heat of the engine to heat the stationary vehicle. The indicator lamp in the button lights up.
- Only use demisting mode until the misted windscreen is clear again (▷ page 121).
- Only use air-recirculation mode briefly, e.g. if there are unpleasant odours or in dusty conditions. The windscreen and the window may otherwise mist up as the flow of fresh air is deactivated and the air inside the vehicle is circulated.

Heating/air-conditioning system with auxiliary heating

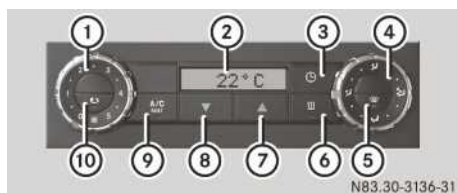

- ① Sets the airflow (▷ page 121)
- ② Display
- ③ Sets the programmed times for: auxiliary heating (▷ page 126), engine preheating (▷ page 126)
- ④ Setting the air distribution (▷ page 121)
- ⑤ Defrosts the windscreen (▷ page 121)
- ⑥ Switches the auxiliary heating on/off (▷ page 126)
- ⑦ Increases temperature (▷ page 120), changes settings for programmed times (▷ page 126)
- ⑧ Reduces temperature (▷ page 120), changes settings for programmed times (▷ page 126)
- ⑨ Switches the cooling or cooling with air dehumidification function on/off (▷ page 118), switches residual engine heat utilisation on/off (▷ page 122)
- ⑩ Switches air recirculation mode on/off (▷ page 122)

Heating with auxiliary heating is a heating and ventilation system without a cooling system.

The air-conditioning system with auxiliary heating is a combination of a heating and ventilation system, a cooling system and an auxiliary heating system.

Recommendations for optimal climate control:

- Set the temperature to 22 °C. Only change the temperature in small increments.
- Air conditioning: switch cooling or cooling with air dehumidification on. The indicator lamp in the or button lights up.
- After long journeys, use the residual heat of the engine to heat the stationary vehicle. The indicator lamp in the or button lights up.

- Only use demisting mode until the misted windscreen is clear again.
- Only use air-recirculation mode briefly, e.g. if there are unpleasant odours or in dusty conditions. The windscreen and the window may otherwise mist up as the flow of fresh air is deactivated and the air inside the vehicle is circulated.

Automatic climate control

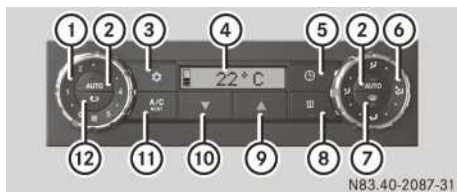

- ① Sets the airflow (▷ page 121)
- ② **AUTO** Switches on automatic mode – regulates climate control automatically (▷ page 119)
- ③ Activates/deactivates the auxiliary air conditioning when stationary (▷ page 124)
- ④ Display
- ⑤ Sets the programmed times for: auxiliary heating (▷ page 126), auxiliary air conditioning (▷ page 124), engine preheating (▷ page 126)
- ⑥ Setting the air distribution (▷ page 121)
- ⑦ Defrosts the windscreen (▷ page 121)
- ⑧ Switches the auxiliary heating on/off (▷ page 126)
- ⑨ Increases temperature (▷ page 120), changes settings for programmed times (▷ page 126)
- ⑩ Reduces temperature (▷ page 120), changes settings for programmed times (▷ page 126)
- ⑪ / Switches the cooling or cooling with air dehumidification function on/off (▷ page 118), switches residual engine heat utilisation on/off (▷ page 122)
- ⑫ Switches air recirculation mode on/off (▷ page 122)

Automatic climate control is a combination of an automatic heating and ventilation system and a cooling system. The automatic climate control

can also control an auxiliary heating system and/or an auxiliary air-conditioning system.

Recommendations for optimal climate control:

- Switch on automatic mode. All basic functions are controlled automatically and the cooling function is activated. The indicator lamp in the **AUTO** button lights up.
- Set the temperature to 22 °C. Only change the temperature in small increments.
- After long journeys, use the residual heat of the engine to heat the stationary vehicle. The indicator lamp in the **A/C REST** button lights up.
- Only use demisting mode until the misted windscreen is clear again.
- Only use air-recirculation mode briefly, e.g. if there are unpleasant odours or in dusty conditions. The windscreen and the window may otherwise mist up as the flow of fresh air is deactivated and the air inside the vehicle is circulated.

Switching the cooling with air dehumidification function on/off

General notes

For vehicles with an air-conditioning system or automatic climate control you can cool down and dry the air inside the vehicle during warm weather to a set temperature.

Depending on the equipment, the "cooling with air dehumidification" function can be switched on with one or two levels.

If the function has been switched on with two levels, switch off the "cooling" function first to cool the air inside the vehicle. The indicator lamp in the **A/C** or **A/C REST** button is then lit green. When necessary, you can also switch on the "dehumidification" function. The air inside the vehicle will then also dehumidify and the windows and the windscreen cannot mist up. The indicator lamp in the **A/C** or **A/C REST** button is then lit red.



The "cooling" function is more fuel-efficient than the "cooling with air dehumidification" function. Only switch on the "cooling with air dehumidification" function if the windows and the windscreen mist up.

If the function is switched on using one level, you can only switch on the "cooling with air dehumidification" function. The indicator lamp in the **A/C** or **A/C REST** button is then lit red.







Condensation may appear on the underside of the vehicle in cooling mode.

Air-conditioning system

Single-stage function



- ▶ Press the  or  button .
If the indicator lamp in the button lights up red, cooling with air dehumidification is switched on.

Dual-stage function

- ▶ **To switch on:** press the  or  button .
The indicator lamp in the button lights up green. The "cooling" function is switched on.
- ▶ Press the  or  button again .
The indicator lamp in the button lights up red. The "cooling" function with air dehumidification" is switched on.
- ▶ **To switch off:** press the  or  button .
If the indicator lamp in the button goes out, the cooling functions have switched off.

Automatic climate control



Single-stage function

- ▶ Press the  button .
If the indicator lamp in the button lights up, the cooling with air dehumidification function is switched on.
- or
- ▶ Press one of the  buttons .
If the indicator lamps in the buttons light up, climate control is adjusted automatically (▷ page 119).

Dual-stage function

- ▶ **To activate:** press the  button .
The indicator lamp in the button lights up green and the **ECO** display appears briefly. The "cooling" function is switched on.

or



- ▶ Press one of the  buttons .
If the indicator lamps in the buttons light up, climate control is adjusted automatically (▷ page 119).
- ▶ Press the  button again.
The indicator lamp in the button lights up red and the **ECO** display appears briefly. The "cooling with air dehumidification" function is switched on.

- ▶ **i** After starting the engine, the "cooling" function is switched back on.

- ▶ **To deactivate:** press the  button .
If the indicator lamp in the button goes out, the cooling functions have switched off.

Setting climate control to automatic

On vehicles with automatic climate control, you can activate/deactivate automatic mode. Automatic climate control regulates the air distribution and airflow automatically depending on the selected temperature and activates the "cooling" function. In automatic mode, the airflow or the air distribution can also be adjusted manually.

- ▶ **To activate:** set the temperature (▷ page 120).
- ▶ Press one of the  buttons .
If the indicator lamps in the buttons light up, the automatic mode is activated.
- ▶ **To deactivate automatic airflow or air distribution:** press the  button in the airflow control or the air-distribution control.

or

- ▶ Set the airflow (▷ page 121) or air distribution (▷ page 121).
The indicator lamp in the respective  button goes out. Airflow or air distribution is set according to the position of the thumbwheel.

- ▶ **To deactivate:** press both of the **AUTO** buttons .

or

- ▶ Set the airflow (▷ page 121) and the air distribution (▷ page 121).

The indicator lamps in the **AUTO** buttons go out. The automatic air conditioning system adopts the current settings. Cooling with air dehumidification remains on.

Setting the temperature

Heating/air-conditioning system

- ▶ Turn temperature selector ③ clockwise to increase or anti-clockwise to reduce the temperature. Start in the centre position or at 22 °C.

Only alter the temperature in small increments (▷ page 116).

Automatic climate control and heating/air-conditioning system with auxiliary heating

- ▶ Press the **▲** or **▼** button. Start at 22 °C. Only alter the temperature in small increments.

The selected temperature is shown in the display.

If a temperature above 32 °C is selected **HI** appears in the display.

If a temperature below 16 °C is selected **LO** appears in the display.

Adjusting the air vents

General notes

Fixed air vents ventilate either the entire cab or just the windscreen or footwell. You can direct air towards the driver's and the co-driver's workstations independently of one another using the adjustable centre and side air vents. Keep all air vents and ventilation grilles in the cab free from obstruction to ensure that the air can flow freely into the cab.

For virtually draught-free ventilation, move the centre and side air vent sliders to the central position and the vertical thumbwheel of the

centre air vent in the driver's workstation all the way to the top.

Centre air vents

Driver's workstation



- ▶ Turn thumbwheel ② to position **I** to open the centre air vent and towards the steering wheel to close it.
- ▶ Turn thumbwheel ② past position **I**. The centre air vent is completely open and the vertical fins are adjusted in accordance with the direction of rotation.
- ▶ Turn thumbwheel ① up or down to the 1st detent. The horizontal fins are adjusted in accordance with the direction of rotation.
- ▶ Turn thumbwheel ① up past the 1st detent. The horizontal fins are increasingly fanned out. The airflow coming from the centre air vent is then diffused.

Co-driver's workstation



- ▶ Turn thumbwheel ① to position **1** to open the centre air vent and to position **0** to close it.

Side air vents

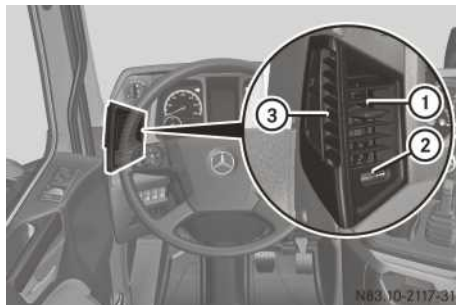

Side air vent (example: driver's side)

- ▶ Turn thumbwheel (2) outwards to open and to position 0 to close side air vent (1).





If thumbwheel (2) is turned fully outwards past the detent to the  position, demister vent (3) is opened.

Setting the air distribution

General notes

Air can be channelled through the fixed air vents using the air-distribution control. Air is also channelled through the adjustable side and central vents regardless of the position of the air-distribution control.

The air distribution symbols have the following meanings:

-  Also directs air to the windscreen
-  Also directs air to the windscreen and into the entire cab
-  Also directs air to the footwell
-  Directs air to the central and side vents only

Heating/air-conditioning system

- ▶ Set air-distribution control for heating/air conditioning (5) to the corresponding symbol (▷ page 116).

Heating/air-conditioning system with auxiliary heating

- ▶ Set air-distribution control for heating/air conditioning (4) to the corresponding symbol (▷ page 116).

Automatic climate control

- ▶ Set air-distribution control (6) to the corresponding symbol (▷ page 116).
- or
- ▶ Press one of the **AUTO** buttons. If the indicator lamp in the **AUTO** button of the air distribution control is also lit, air distribution is controlled automatically (▷ page 119).

Setting the airflow

Heating/air-conditioning system

- ▶ Set airflow control (1)  to the desired level (▷ page 116).

Automatic climate control

- ▶ Set airflow control (1)  to the desired level (▷ page 116).

or

- ▶ Press one of the **AUTO** buttons. If the indicator lamp in the **AUTO** button of the airflow control is also lit, the airflow is controlled automatically (▷ page 119).

Demisting the windscreen and windows





General notes

You should only select the following setting until the windscreen is clear again.

- ▶ **Vehicles with windscreen heating:** switch on the windscreen heating (▷ page 102).

Heating/air-conditioning system



Only use the following settings until the windscreen and windows are clear again.

- ▶ Set temperature control ③ to  (▷ page 116).
- ▶ Set air-distribution control ⑤ to  .
- ▶ Turn airflow control ① to position 5.
- ▶ Close the centre air vents (▷ page 120).
- ▶ Turn the thumbwheel on the side air vent all the way outwards past the detent to the  position (▷ page 120).

Automatic climate control and heating/air-conditioning system with auxiliary heating

Only use the following settings until the windscreen and windows are clear again.

The defrost function automatically:

- switches the temperature to **HI**
- deactivates air-recirculation mode
- sets the airflow to maximum
- guides air distribution towards the windscreen and the window
- ▶ **To switch on:** press the  button. The indicator lamp in the button lights up.
- ▶ Turn the thumbwheel on the side air vent all the way outwards past the detent to the  position (▷ page 120).
- ▶ **To deactivate:** press the  button. The indicator lamp in the button goes out. The previous settings for the airflow and the air distribution come into effect again.

or

- ▶ Press one of the **AUTO** buttons on the automatic climate control panel. The indicator lamp in the  button goes out. The indicator lamps in the **AUTO** buttons light up. Automatic climate control automatically controls all basic functions (▷ page 119).

Switching air recirculation mode on/off

If you switch the air-recirculation mode on, the windscreens may mist up more quickly, espe-

cially at low outside temperatures. Only switch air-recirculation mode on for a short time.

Switch the flow of fresh air off temporarily and switch on air-recirculation mode if there are unpleasant odours or in dusty conditions.

- ▶ Close the window, roof hatch, pop-up roof or sliding sunroof.
- ▶ Press the  button. If the indicator lamp in the button lights up, air-recirculation mode is activated.

Switching residual engine heat utilisation on/off

On vehicles with residual engine heat utilisation, you can use the residual heat of the engine to heat the vehicle for up to 90 minutes when stopped.

If you deactivate residual engine heat utilisation, the auxiliary air conditioning system (▷ page 123) and the auxiliary heating system (▷ page 126) are deactivated automatically.

- ▶ Press the **REST** or  button. If the indicator lamp in the button lights up, residual engine heat utilisation is activated.
- ▶ Set the temperature, airflow, air distribution and air vents as desired. The automatic air conditioning system automatically switches to automatic mode (▷ page 119).

Residual engine heat utilisation switches off automatically:

- when you start the engine
- after a maximum of approximately 90 minutes depending on the set temperature and the coolant temperature

Switching the auxiliary ventilation on/off

- ▶ **To switch on:** turn the ignition lock to the radio position.
- ▶ Set airflow control ① to the desired level (▷ page 116). The blower ventilates the cab.
- ▶ **To switch off:** slide airflow control ① to the left to position 0.

- i** Note that the battery may discharge if the auxiliary ventilation is left running.

Electrical auxiliary air conditioning

General notes

The auxiliary air conditioning cools the air inside the vehicle to the set temperature regardless of whether the engine is running or not.

The auxiliary air conditioning is operated using the automatic climate control panel (▷ page 116) or the bed/berth switch panel (▷ page 124).

The auxiliary air conditioning can be activated/deactivated manually (immediate cooling mode) or up to 2 switch-on times can be defined.

The operating time of the auxiliary air conditioning system depends on:

- the external conditions – outside temperature and sunlight
- the set interior temperature
- the charge status and age of the batteries
- the use of other electrical consumers
- the driving cycle

The operating time of the auxiliary air conditioning system can be up to 8 hours. The operating time of the auxiliary air conditioning system decreases with the age of the batteries.

The auxiliary air conditioning system is not supplied with voltage from separate auxiliary batteries but solely from the vehicle's battery. The output of the auxiliary air conditioning system is automatically reduced in increments or switched off to preserve the starting ability of the vehicle and the service life of the battery.

After an automatic deactivation, the auxiliary air conditioning system can be switched on again once the battery has been loaded after a sufficient driving time. In short-distance driving, the charging phases are too short to sufficiently charge the batteries to operate the auxiliary air conditioning system. In this case, use of the auxiliary air conditioning system may be restricted.

Observe the notes on battery maintenance and care (▷ page 366).

- i** When driving, cool the cab to a comfortable temperature. At very high exterior temperatures, minimise using other electrical devices

in the cab before and while using the auxiliary air conditioning.

If you close the curtains and move the backrests forwards, less heat will enter the cab and the auxiliary air conditioning will be more effective.

The auxiliary air conditioning control system supplements the cooled air inside the vehicle with fresh air when required. This means you can keep the windows closed during an overnight stop or when parked for long periods.

When switched on, the blower of the auxiliary air conditioning operates in an automatic mode, which can be switched off if necessary. In automatic mode, the auxiliary air conditioning controls the airflow automatically. In automatic mode, when the temperature of the outside air is sufficiently low to cool the air inside the vehicle, the auxiliary air conditioning switches to a fresh air mode. Therefore, the service life increases since the battery is treated with sufficient care.

If auxiliary heating is activated manually or by the switch-on time, auxiliary air conditioning (▷ page 126) and residual engine heat utilisation (▷ page 122) are deactivated automatically.

Setting the air distribution

For an even distribution of air in the cab, the air-recirculation mode and the blower of the automatic air conditioning are automatically switched on. Fresh air intake is automatically fed into the air inside the vehicle.

In automatic mode the cooled air flows from the centre and side air vents. Adjust the centre and side air vents as necessary.

If you also use the upper bed:

- ▶ Close the side air vents.
- ▶ Open the centre air vents fully and adjust so that the airflow is directed inwards and up as much as possible.

Immediate cooling mode

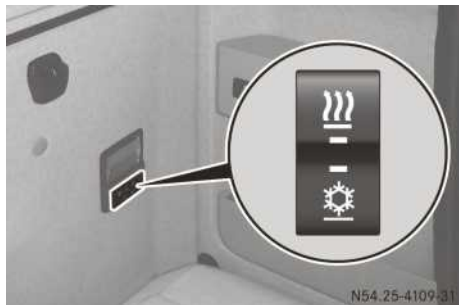

Additional button on the bed/berth switch panel (example: vehicle with auxiliary heating)

▶ **To switch on/off:** press the button on the control panel of the automatic climate control (▶ page 116).

or

▶ Press the button bed/berth switch panel.
If the indicator lamps in the and switches light up, auxiliary air conditioning is activated. The airflow is controlled automatically.

▶ If necessary, adjust the airflow manually on the automatic air conditioning control panel. Only the first three airflow control settings can be selected.

When you start the engine, the auxiliary air conditioning switches off automatically.

Setting the switch-on time

Select an option shown in the control panel display by pressing the or button. The selected option flashes. Press the button to confirm the selection. When selecting the settings, ensure that the set operating times do not overlap.

▶ Switch the ignition lock to the drive position.
▶ Press the button on the control panel of the automatic climate control.

Display in the control panel shows both memory positions and . The number of the selected memory position flashes.

▶ Press the or button to select the memory position.

▶ Press the button .
Display shows the selected climate control systems, the auxiliary air conditioning, the auxiliary heating and the engine preheating.

▶ Press the or button to select the auxiliary air conditioning.

i If no symbol is selected and no symbol flashes, the corresponding memory position is deleted.

▶ Press the button .

i Vehicles with auxiliary heating: when setting the time and date, ensure that the auxiliary heating and engine preheating operating times do not overlap.

▶ Press the or button to select the day.

▶ Press the button .

▶ Press the or button to set the hour.

▶ Press the button .

▶ Press the or button to set the minute.

▶ Press the button .

▶ Press the or button to set the temperature.

▶ Press the button .

Display shows the temperature, the timer symbol and the selected memory position.

▶ For optimal air distribution in the cab, open the central and side vents.

▶ Switch the ignition lock to position **0** and remove the key.

The auxiliary air conditioning is activated automatically at the set switch-on time. If the indicator lamps in the switch in the control panel and in the switch in the bed/berth light up, the auxiliary air conditioning is activated.

Auxiliary air conditioning is deactivated automatically after approximately 2 hours or when the engine is started.

Auxiliary heating

Important safety notes

DANGER

If the exhaust pipe is blocked or sufficient ventilation is not possible, toxic exhaust fumes may enter the vehicle, especially carbon monoxide. This is the case in enclosed spaces or if the vehicle is stuck in snow, for example. There is a risk of fatal injuries.

Switch off the auxiliary heating in enclosed spaces without extraction systems, e.g. in a garage. If the vehicle is stuck in snow and you have to leave the auxiliary heating running, keep the exhaust pipe and the area around the vehicle clear of snow. To guarantee a sufficient supply of fresh air, open a window on the side of the vehicle away from the wind.

WARNING

You could burn yourself on the exhaust pipe if the auxiliary heating system has been running. There is a risk of injury.

Let the exhaust pipe cool down before carrying out work on the auxiliary heating system.

! If the auxiliary heating has not been used for an extended period, exposure to heat and condensation can lead to deposits forming in the auxiliary heating fuel system. These deposits can cause the auxiliary heating to malfunction. Have the auxiliary heating checked and repaired at a qualified specialist workshop before using it again.

! The auxiliary heating system should be switched on once a month for approximately 15 minutes. Otherwise, the auxiliary heating could be damaged.

! The auxiliary heating may only be operated with conventional diesel fuel. Operating with 100 % fatty acid methyl ester (FAME) fuel or diesel fuel with an admixture of more than 10 % fatty acid methyl ester (FAME) fuel can lead to malfunctions and is therefore not permitted.

An additional fuel tank for conventional diesel fuel is required for the auxiliary heating system, if you operate the vehicle:

- using fatty acid methyl ester (FAME) fuel
- using conventional diesel fuel with the addition of more than 10 % fatty acid methyl ester (FAME) fuel

The auxiliary heating system operates independently of the engine and complements the vehicle heating. Auxiliary heating can also be switched on when the engine is running and at low outside temperatures to support the heating (heater booster function).

Auxiliary heating is operated using the control panel of the heating, air-conditioning system or automatic climate control (▷ page 116) or using the bed/berth switch panel.

Auxiliary heating heats the cab. If your vehicle is equipped with an engine preheating system, auxiliary heating can also heat the coolant. The engine preheating system therefore also reduces the load on the engine and saves fuel. Auxiliary heating can be activated/deactivated manually or up to 2 switch-on times can be defined.

If auxiliary heating is activated manually or via the switch-on times, auxiliary air conditioning (▷ page 123) and residual engine heat utilisation (▷ page 122) are deactivated automatically.

Mandatory switch-off

! Only use the battery isolator switch when the auxiliary heating is running if there is a risk of danger. If the heater is switched off without a run-on period, it may be damaged.

Vehicles transporting hazardous goods: you must switch off the heater before entering a hazardous area (e.g. a refinery).

For safety reasons for these vehicles:

- no switch-on time can be set
- the engine preheating can only be activated with the immediate heating mode

The heater automatically switches off if you switch off the engine or engage power take-off. The combustion air blower continues to operate briefly after it has been switched off and then switches off automatically.

Immediate heating mode

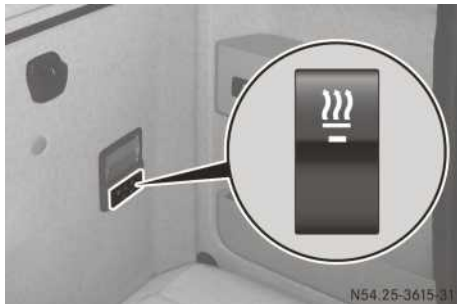



Additional button on the bed/berth switch panel (example: vehicle without auxiliary air conditioning)

► **To switch on/off:** press the  button on the control panel of the heating, air-conditioning system or automatic climate control.

or

► Press the  button on the bed/berth switch panel.

If the indicator lamps in the  and  buttons light up, the auxiliary heating is activated.

► Set the temperature, airflow, air distribution and air vents as desired.

The automatic air conditioning system automatically switches to automatic mode (▷ page 119).

i Depending on the coolant temperature, there may be a delay before the blower starts.

The auxiliary heating system switches off automatically after approximately 11 hours. The auxiliary heating runs on for approximately 2 minutes after being switched off.

Vehicles transporting hazardous goods with engine preheating: you can only activate the engine preheating with the immediate heating mode.

► **To activate engine preheating:** activate immediate heating mode.

► Press the  button on the control panel of the heating, air-conditioning system or automatic climate control.

The engine preheating automatically switches off with the auxiliary heating.

Setting the switch-on time



DANGER

If you have preselected a switch-on time, the auxiliary heating system switches on automatically.

- Toxic exhaust fumes may accumulate if there is insufficient ventilation, carbon monoxide in particular. This is the case in enclosed spaces, for example. There is a risk of fatal injuries.
- There is a risk of fire and explosion if there are highly flammable materials or flammable materials nearby!

If you park the vehicle in these or similar conditions, always deactivate the preselected switch-on times.

Switch-on times can be set for auxiliary heating (heating of the cab) and for engine preheating (heating of the coolant). If your vehicle is equipped for transporting hazardous goods, no switch-on times can be set.

Select an option shown in the control panel display by pressing the  button or the  button. The selected option flashes. Press the  button to confirm the selection. When selecting the settings, ensure that the set operating times do not overlap.



► Switch the ignition lock to the drive position.

► Press the  button on the control panel of the heating, air-conditioning system or automatic climate control.

Display in the control panel shows both memory positions **1** and **2**. The number of the selected memory position flashes.

► Press the  or  button to select the memory position.

► Press the  button .

Display shows the selected climate control systems, the  auxiliary air conditioning, the  auxiliary heating and the  engine preheating.















► Press the  or  button to select  auxiliary heating or  engine preheating.

i If no symbol is selected, the corresponding memory position is deleted.

► Press the  button .

i For vehicles with auxiliary air conditioning: when setting the time and date, ensure that

the operating time does not overlap with the operating time of the auxiliary air conditioning.

- ▶ Press the  or  button to select the day.
- ▶ Press the  button .
- ▶ Press the  or  button to set the hour.
- ▶ Press the  button .
- ▶ Press the  or  button to set the minute.
- ▶ Press the  button .
- ▶ Set the temperature using the  or  button.
- ▶ Press the  button .
Display shows the temperature, the  timer symbol and the selected memory position.
- ▶ Switch the ignition lock to position **0** and remove the key.
Auxiliary heating and/or engine preheating switch on automatically at the set switch-on times. If the indicator lamps in the  button in the control panel and in the additional  button by the bed/berth light up, auxiliary heating and/or engine preheating are activated.

i On vehicles with residual engine heat utilisation, the residual engine heat is utilised first at the switch-on time. The auxiliary heating system then switches on after a delay once residual engine heat utilisation has switched off automatically.

- ▶ If you activate the switch-on time: open the middle and side air vents (▷ page 120).
- ▶ Heating or air conditioning: set the air-distribution control to .
- ▶ Heating or air conditioning: set the air-distribution control to level **1**.

At the set switch-on time, the automatic air conditioning system automatically switches to automatic mode (▷ page 119).

When the coolant temperature is sufficiently high, the cab will also be heated while the engine preheater is running.

The switch-on time for the engine preheater can also be programmed while the auxiliary heating is running. The auxiliary heating continues to run after the activation of the engine preheater.

The engine preheating and auxiliary heating systems switch off automatically after approximately 2 hours. The auxiliary heating runs on for approximately 2 minutes after shutdown.

Useful information

These Operating Instructions describe all the models and standard and optional equipment of your vehicle that were available at the time of going to print. Country-specific differences are possible. Bear in mind that your vehicle may not be equipped with all the functions described. This also applies to safety-relevant systems and functions.

Read the information on qualified specialist workshops (▷ page 31).

Instrument cluster

Important safety notes

⚠ WARNING

Operating the integrated information systems and communications equipment in the vehicle while driving will distract you from traffic conditions. You could then lose control of the vehicle. There is a risk of an accident.

Only operate these devices if road traffic conditions permit. If you are unsure about the surrounding conditions, pull over to a safe location and make entries only while the vehicle is stationary.

⚠ WARNING

If the instrument cluster has failed or there is a malfunction, you may not know about safety-related function restrictions. The operating safety of your vehicle may be affected. There is a risk of an accident.

Immediately stop the vehicle while paying attention to the traffic conditions and consult a qualified specialist workshop.

Observe the legal requirements for the country you are currently in while operating the instrument cluster.

The on-board computer only shows messages or warnings from certain systems in the display. You should therefore make sure your vehicle is operating safely at all times. Otherwise, you could cause an accident by driving an unsafe vehicle. If your vehicle is not operating safely,

stop immediately, paying attention to the road and traffic conditions.

Rev counter

! If you exceed the maximum permissible engine speed, the warning tone sounds.

You should not drive and change gear by the sound of the engine, but according to the engine speed shown in the rev counter.

Avoid driving in the red overrevving range. This could lead to engine damage.

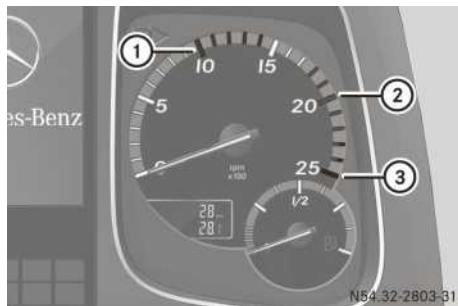

Example: instrument cluster

- ① Economical operating range (green)
- ② Engine brake operating range (yellow)
- ③ Overrevving range, danger of engine damage (red)

If the  indicator lamp in the instrument cluster lights up, the engine speed is high, e.g. if you select a low gear when shifting down. Observe further information in the event window of the on-board computer.

► Decelerate using the service brake.

or

► Shift up a gear.

The  indicator lamp in the instrument cluster goes out.

General notes on the rev counter:

- Observe the rev counter while driving and stay within economical speed range ①.

In some situations, it may make sense to operate the engine outside economical engine speed range ①, e.g. on uphill gradients or when overtaking.

- If you drive the vehicle within economical engine speed range ①, you achieve low fuel consumption and reduced wear.

- In engine braking mode, use yellow engine speed range ②. The highest engine braking effect will be achieved just before red over-revving range ③.
 - When driving downhill, make sure that the engine speed does not rise into red over-revving range ③.
 - Idling speed is set automatically depending on the coolant temperature.
 - When the vehicle is stationary, the engine is running and the transmission is in neutral, throttle response is intentionally slow.
- i** Observe information on your economical driving style in the **FleetBoard EcoSupport** menu window in the driving mode menu  (> page 138). The on-board computer can support you in optimising your driving style and developing a fuel-saving driving style.

AdBlue® gauge





Example: instrument cluster

The AdBlue® gauge is only available on vehicles with BlueTec® exhaust gas aftertreatment.

The AdBlue® reducing agent is required for reduction of engine emissions.

The operating permit is invalidated if the vehicle is operated without AdBlue®. The legal consequence of this is that the vehicle may no longer be operated on public roads.

In the **Range** menu window of the  trip data menu, you can display your vehicle's range based on the current fuel tank content (> page 138).

If the AdBlue® level has dropped to approximately 10% of the tank capacity, a corresponding event window appears with the  symbol in the on-board computer. Top up the AdBlue® tank in good time (> page 318).

BlueTec® 4 vehicles and BlueTec® 5 vehicles: if you do not observe the yellow event window and you drive until the AdBlue® tank is empty, engine output may be reduced.



BlueTec® 6 vehicles: if you do not observe the yellow event window and the AdBlue® level drops to 2.5%, engine output may be reduced.

When the AdBlue® tank has run dry, the event is stored and is signalled by the  indicator lamp when starting the engine as an emission-relevant fault (> page 130). Additionally, speed may be limited to approximately 20 km/h.

Fuel gauge



Example: instrument cluster

If the  fuel level has dropped to approximately 14% of the tank capacity, the needle enters the red reserve area. The on-board computer displays a corresponding event window with the  symbol.

In the **Range** menu window of the  trip data menu, you can display your vehicle's range based on the current fuel tank content (> page 138).

Clock and outside temperature



Instrument cluster (example: display in speedometer)

You should pay special attention to road conditions when temperatures are around freezing point.

Please observe that the outside temperature display shows the measured air temperature and does not record the temperature on the street.

There is a delay in displaying a change in outside temperature.

- ▶ Switch the ignition lock to the drive position. The display in the speedometer shows time ① and outside temperature ②.

The clock and outside temperature gauge also display the **Truck info** menu window in the trip data menu  (▷ page 137). You can change the clock mode and the temperature unit in the



Menu menu window within the  settings menu (▷ page 149).

Odometer



Instrument cluster (example: display in rev counter)

- ▶ Switch the ignition lock to the drive position. The display in the speedometer shows total distance ① and trip distance ②.



The total distance recorder and trip meter also display the **Truck info** menu window in the  trip data menu (▷ page 137). You can change the units of measurement in the **Menu** menu window in the  settings menu (▷ page 149). You can reset trip distance ② in the **Truck info** menu window in the  trip data menu (▷ page 137).

Engine diagnostics indicator lamp

Vehicles without BlueTec® exhaust gas aftertreatment



Problem	Possible causes/consequences and ▶ Solutions
The  indicator lamp lights up, then goes off again after starting the engine.	If there are no malfunctions, the indicator lamp lights up briefly during the instrument cluster's display check and then goes out after the engine starts.







BlueTec® 4 vehicles and BlueTec® 5 vehicles

Problem	Possible causes/consequences and ► Solutions
The  indicator lamp lights up, then goes off again after starting the engine.	If there are no malfunctions, the indicator lamp lights up briefly during the instrument cluster's display check and then goes out after the engine starts.
The  indicator lamp flashes. The on-board computer displays an event window.	AdBlue® has been used up or an emissions-related malfunction has been detected. The engine output may be reduced. ► Follow the instructions in the event window. ► Drive carefully to the nearest filling station and refill AdBlue® (> page 318). or ► Drive carefully to the nearest qualified specialist workshop and have the malfunction rectified immediately.
The  indicator lamp lights up.	The BlueTec® exhaust gas aftertreatment is malfunctioning or has an emissions-related fault. The malfunction or defect may damage the BlueTec® exhaust gas aftertreatment. ► If the on-board computer displays an event window, observe the information. ► Have the BlueTec® exhaust gas aftertreatment checked immediately at a qualified specialist workshop.

- i** Once the AdBlue® tank has been refilled or the fault rectified, full engine output is restored. If the system check does not detect any other faults, the  indicator lamp goes out. It may take several journeys to complete the system check

BlueTec® 6 vehicles

Problem	Possible causes/consequences and ► Solutions
The  indicator lamp flashes.	After you have switched the ignition lock into drive position, the indicator lamp indicates the system's status by means of a sequence of flashes. If there are no malfunctions, the indicator lamp goes out after the engine is started (> page 133).
The  indicator lamp lights up and remains lit after the engine is started.	The BlueTec® exhaust gas aftertreatment is malfunctioning or has an emissions-related fault. The malfunction or defect may damage the BlueTec® exhaust gas aftertreatment. ► If the on-board computer displays an event window, observe the information. ► Have the BlueTec® exhaust gas aftertreatment checked immediately at a qualified specialist workshop.

Problem	Possible causes/consequences and ► Solutions
<p>The  indicator lamp lights up.</p> <p>The on-board computer shows an event window and the  indicator lamp in the display.</p>	<p>An emissions-related malfunction has been detected.</p> <ul style="list-style-type: none"> ► Follow the instructions in the event window. ► Have the BlueTec® exhaust gas aftertreatment checked immediately at a qualified specialist workshop. <p>If you do not follow the instructions in the event window, a reduction in the engine power output may be imposed, as per the message displayed:</p> <ul style="list-style-type: none"> • after approximately 10 hours, e.g. if a low-grade diluted reducing agent is being used or if the dosage is incorrect • after approximately 36 hours, e.g. if the exhaust gas recirculation or the security system is faulty <p>In certain cases, engine output may be reduced even earlier.</p>
<p>The  indicator lamp lights up.</p> <p>The engine power output is reduced. The on-board computer also shows an event window and the  indicator lamp in the display.</p>	<p>You have not rectified a detected emissions-related malfunction.</p> <ul style="list-style-type: none"> ► Follow the instructions in the event window. ► Drive carefully to the nearest qualified specialist workshop and have the malfunction rectified immediately. <p>If you do not follow the instructions in the event window, a speed limitation may be imposed, as per the message displayed:</p> <ul style="list-style-type: none"> • approximately 20 hours after the first occurrence of a malfunction, e.g. if a low-grade diluted reducing agent is being used or if the dosage is incorrect • approximately 100 hours after the first occurrence of a malfunction, e.g. if the exhaust gas recirculation or the security system is faulty <p>In certain cases, speed limitation may be imposed even earlier.</p>
<p>The  indicator lamp lights up.</p> <p>Vehicle speed is limited to approx. 20 km/h. Simultaneously, the on-board computer shows the  indicator lamp in the status area.</p>	<p>AdBlue® has been used up or a detected emissions-related malfunction has not been rectified.</p> <ul style="list-style-type: none"> ► Follow the instructions in the event message. ► Drive carefully to the nearest filling station and refill AdBlue® (► page 318). <p>or</p> <ul style="list-style-type: none"> ► Drive carefully to the nearest qualified specialist workshop and have the malfunction rectified immediately. <p>The operating permit is invalidated if you continue to use the vehicle.</p>

i Once the AdBlue® tank has been refilled or the fault rectified, full engine output is restored. If the system check does not detect any other faults, the  indicator lamp goes out after the system's status indicator. It may take several journeys to complete the system check. When low quality or diluted reducing agent is in the AdBlue® tank, the tank must be emptied and then refilled with AdBlue/DEF according to DIN 70070/ISO. Subsequently, a system check can be initiated. Also carry out manual regeneration (► page 312).

BlueTec® exhaust gas aftertreatment status indicator

Only on BlueTec®6 vehicles, the status of the BlueTec® exhaust gas aftertreatment is signalled for a quick on-site check by authorities.

There are three successive signalling phases shown by the  indicator lamp. These commence when the ignition starter switch unit is switched to the drive position and end when the engine is started.

The first phase is the instrument cluster display check. The indicator lamp lights up for approximately 5 seconds and then goes out for approximately 10 seconds. The second phase indicates the system check status. The indicator lamp either lights up again for 5 seconds or flashes for approximately 5 seconds. Subsequently, it goes out for 5 seconds.

In the third phase, the indicator lamp indicates whether any emissions-related malfunctions have been detected.

If no emissions-related malfunctions are detected, the indicator lamp lights up briefly and then goes out for approximately 5 seconds. This flashing sequence is repeated until the engine is started.

If an emissions-related malfunction is detected, the indicator lamp flashes three times and then goes out for approximately 5 seconds. This flashing sequence is repeated until the engine is started. The indicator lamp remains lit for approximately 15 seconds after the engine is started.

The indicator lamp lights up and remains lit after the engine is started if:

- a serious emissions-related malfunction is detected
- an emissions-related malfunction is still present and more than 200 hours have elapsed since detection

On-board computer

Operating the on-board computer

WARNING

Operating the integrated information systems and communications equipment in the vehicle while driving will distract you from traffic con-





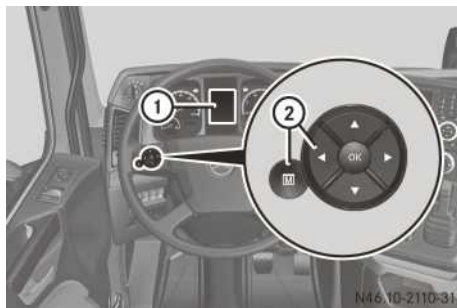

ditions. You could then lose control of the vehicle. There is a risk of an accident.

Only operate these devices if road traffic conditions permit. If you are unsure about the surrounding conditions, pull over to a safe location and make entries only while the vehicle is stationary.

Observe the legal requirements for the country you are currently in while operating the on-board computer.



The on-board computer only shows messages or warnings from certain systems in the display. You should therefore make sure your vehicle is operating safely at all times. Otherwise, you could cause an accident by driving an unsafe vehicle. If your vehicle is not operating safely, stop immediately, paying attention to the road and traffic conditions.















- ① On-board computer display
 - ② Buttons
-  Selects the next main menu/next entry in the input window, increases or resets value
 -  Selects the previous main menu/previous entry in the input window or decreases value
 -  Next menu window/next menu bar down in the input window
 -  Previous menu window/next menu bar up in the input window
 -  Opens and closes input window/acknowledges event window
 -  Stores/displays favourite menu window



Navigate through the on-board computer menus using the left group of buttons on the multifunction steering wheel.

Whilst you are driving, the on-board computer provides information about:

- fuel consumption
 - trip time
 - operating conditions
 - maintenance due dates
 - malfunctions
 - causes of malfunctions
 - measures to be taken
- Switch the ignition lock to the radio position. The on-board computer shows the welcome display (Mercedes star). After a short time the display also shows the date and time.
- Switch the ignition lock to the drive position. The on-board computer shows the last active menu window, e.g. the **Truck info** menu window in the  trip data menu.
- If a malfunction is detected, the on-board computer will display the events in an event window first. In addition to the event window, an indicator lamp may light up in the instrument cluster or in the status area of the on-board computer. If there are several messages, the on-board computer shows them one by one according to priority level. If further information on the malfunction is available in the event window, the event window shows the  symbol. You can display the information using the  button.

- Clear the event window by pressing the  button.
- **To scroll through the main menus:** press  or .
- **To display further menu windows in the main menu:** press  or .
- **To open and close the input window:** when a menu window displays the  symbol, press .
- **To select menu bars in the input window:** press  or .
- **To change the value or select an entry in the input window:** press  or .

i If you call up a particular menu window regularly, e.g. the engine oil level check, save it on the  button.

- **To save a favourite menu window:** call up the desired menu window and press the  button for approximately 2 seconds. A tone sounds and the menu window is saved.
- **To display the favourite menu window:** briefly press the  button.

Areas in the display

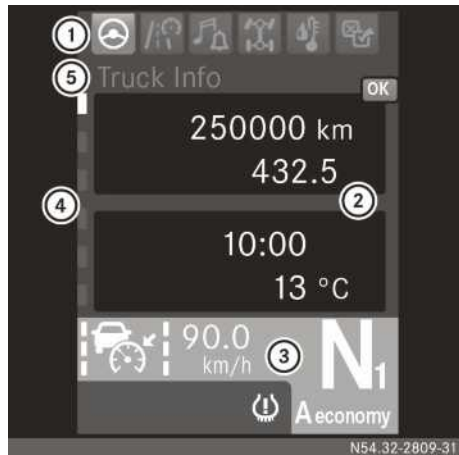

Areas in the display (example: Truck Info menu window)

Register and title bar: register ① shows the main menu. The active main menu is represented in white. Register ④ shows you the number of menu windows (submenus) and which window is currently selected. Title bar ⑤ shows the name of the active menu window.



Display area: the on-board computer displays the menu window or event window in display area ②. Event windows are displayed automatically and contain messages, e.g. **Power take-off active**, or information about malfunctions, e.g. **Turn signal faulty**. In addition to the event window, an indicator lamp may light up in status area ③ of the on-board computer or in the instrument cluster. If you can confirm the event window using the  button, the event window is hidden. An indicator lamp that lights up in status area ③ of the on-board computer or in the instrument cluster does not go out after the event window is confirmed.

Status area: status area ③ shows the selected drive program, for example **A economy**, and the gear indicator, e.g. **N1** (► page 254).

For the following driving systems, status area ③ displays the following corresponding information:

- Cruise control: the  symbol and the set speed, e.g. 85 km/h (▷ page 276)
- Lane Keeping Assist: the lane marking (▷ page 290)

For the following driving systems, status area ③ displays the following corresponding information:

- Cruise control: the  symbol and the set speed, e.g. 85 km/h (▷ page 276)
- Distance control assistant: the  symbol and the set speed, e.g. 85 km/h (▷ page 278)
- Speed limiter: the  symbol and the set limit speed, e.g. 50 km/h (▷ page 275)
- Lane Keeping Assist: the lane marking (▷ page 290)

The status of the driving system, e.g. on or off, is represented in colour.

In addition, status area ③ contains an indicator lamp panel. In the event of a malfunction, warning or operating information, an indicator lamp automatically lights up in status area ③ of the on-board computer. Depending on the priority of the malfunction, warning or operating information, the indicator lamp lights up in different colours. The indicator lamp may also light up in addition to the event window.

Menus at a glance

The number and order of the menus depends on your vehicle's equipment and the type of vehicle itself.

Trip data 	(▷ page 137)
Truck info	Displays the time and outside temperature, displays/resets the trip meter and total distance recorder
Tachograph	Displays driving time and rest periods
Since start - all	Displays/resets trip data from start
Range	Displays the range of fuel and AdBlue® levels



Trip data 	(▷ page 137)
Since reset - all	Displays/resets trip data since Reset - all
Since reset - drive	Displays/resets trip data since Reset - drive

Driving mode 	(▷ page 138)
Speed	Displays vehicle speed
FleetBoard EcoSupport	Displays/resets statistics on your driving style
Navigation	Displays route guidance
Assistance	<ul style="list-style-type: none"> • Displays the distance to the vehicle in front (distance control assistant) • Displays lane markings (Lane Keeping Assist)
Backup drive mode	Selects shift position when experiencing problems with the transmission shift system
Video	Displays/adjusts the reversing camera

Audio and communications 	(▷ page 140)
Alarm clock	<ul style="list-style-type: none"> • Displays the alarm time • Sets the alarm clock • Switches off the alarm
Telephone	Displays the telephone book and the calls list/calls numbers

Audio and communications 	(▷ page 140)
Audio	<ul style="list-style-type: none"> • Controls the volume • Displays the audio source • Changes the audio source, title, station or frequency • Operates the MP3 browser
Mobile devices	Authorise mobile devices for the vehicle's network (Wi-Fi) or remove from the list of authorised devices

Operation and maintenance 	(▷ page 143)
Axles	<ul style="list-style-type: none"> • Displays the axle loads • Sets the axle load indicator
Tyres	Checks the tyre pressures electronically
Level control	<ul style="list-style-type: none"> • Raises/lowers the chassis • Sets the driving level • Stores/calls up a chassis height
Trailer	Displays trailer/semi-trailer data <ul style="list-style-type: none"> • Information on braking • Axle loads • Tyre pressures • Reservoir pressure
Maintenance	Displays/resets the maintenance point and due date

Monitoring info 	(▷ page 148)
Reserve pressure	Displays the reservoir pressure in brake circuits  and 
Coolant	Displays the coolant temperature
Engine	Displays the engine oil level and engine operating hours
Events	Displays events
Diagnosis	Displays diagnostics data

Settings 	(▷ page 149)
Menu	Sets the units system (display of e.g. °C or °F)
Lighting	<ul style="list-style-type: none"> • Adjusts the dipped-beam headlamps • Adjusts the brightness of the instrument lighting and the audio display lighting • Sets the exterior lighting delayed switch-off • Switches the automatic interior lighting control on/off • Switches the nightlight on/off
Language	Sets the language

Settings 	(▷ page 149)
Service products	Displays/sets service product values
Systems	<ul style="list-style-type: none"> Starts or blocks regeneration of the diesel particle filter Switches the drive functions in the automated manual transmission on/off Rocking free/crawler mode or Hydromove/EcoRoll mode <ul style="list-style-type: none"> Switches the driving systems on/off ATTENTION ASSIST/PPC <ul style="list-style-type: none"> Switches video pop-up on/off

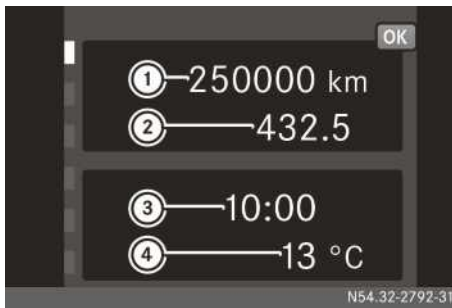

Trip data menu

Truck info menu window



Truck info menu window

- ① Total distance recorder
- ② Trip meter
- ③ Time
- ④ Outside temperature

▶ **To display the total distance recorder, trip meter, time and outside temperature:** use the  or  button to scroll to  trip data.



▶ **To reset the trip meter:** press .



The input window displays the message **Reset trip meter? No/Yes.**

▶ Use the  button to select the **Yes** menu bar and press the  or  button to confirm.

Tachograph menu window

The **Tachograph** menu window is available on vehicles with a digital tachograph.

▶ Use the  or  button to scroll to  trip data.

▶ **To display the driving and rest times:** use the  or  button to scroll to the **Tachograph** menu window.

The menu window shows:

- the driver's name
 - the driving time since your last rest
 - the daily driving time
 - the weekly driving time with the number of daily driving times of more than 9 hours
- A dot in the display changes from green to grey for every extended daily driving time.
- the rest time (maximum 45 minutes)
 - number of times exceeded



Further information on the digital tachograph can be found in the separate operating instructions.

Menu window from start/from reset 1/ from reset 2

The **Since start** trip data includes performance and level data since the start of a journey. If you leave the vehicle parked for more than 4 hours, the values are reset automatically.

The **Since reset 1** or **Since reset 2** trip data contain performance and level values since the last menu window reset.

▶ Use the  or  button to scroll to  trip data.

▶ **To display trip data:** use the  or  button to scroll to the **Since start**, **Since reset 1** or **Since reset 2** menu window.

The menu window shows:

- the distance covered
- the driving time
- the average vehicle speed
- the average fuel consumption

► **To display performance and level data:**

press the  button.



The **Consumption** menu window shows

- the average total fuel consumption
- the average fuel consumption while driving
- the average fuel consumption when stationary

► Using the  or  button to scroll to the **Times** menu window.

The menu window shows

- the total driving time
- the driving time
- the idle time

► Use the  or  button to scroll to the **Speeds** menu window.

The menu window shows:

- the average total vehicle speed
- the average vehicle speed

► **To reset the trip data:** in the **Consumption, Times** or **Speeds** menu window, press the  button.





The input window shows, for example, **Reset values for: Since start No/Yes.**

► Use the  button to select the **Yes** menu bar and press the  or  button to confirm.

Range menu window

The on-board computer calculates the approximate range based on current levels of fuel and AdBlue®. The range depends largely on your driving style.

► Use the  or  button to scroll to  trip data.



► **To display the range:** use the  or  button to scroll to the **Range** menu window. The menu window displays the approximate range of the  fuel level and the  AdBlue® level. In addition, the menu window also shows the current fuel consumption as a bar display underneath the range. When the vehicle is stationary, the bar display changes to display the fuel consumption for the stationary vehicle (l/h). The mark above the bar display corresponds to the **Since start - all** average consumption.

The menu window displays the range up to **50 km**. For lower values, the on-board computer displays **<50 km**.

Driving mode menu

Speed menu window

► Use the  or  button to scroll to  driving mode.

► **To display the vehicle speed:** use the  or  button to scroll to the **Speed** menu window.

FleetBoard EcoSupport menu window

The on-board computer detects your driving style in 8 categories, evaluates it and displays it in the **FleetBoard EcoSupport** menu window. The on-board computer can support you in optimising your driving style and developing a fuel-saving driving style. In order to positively influence the evaluation of your driving style, also observe the driving tips in the "Economical and environmentally-aware driving" section (▷ page 309).

The **FleetBoard EcoSupport** menu window recognises the driver by means of the tachograph driver card and saves the evaluations of 2 drivers. If a third driver inserts his/her driver card into the digital tachograph, the oldest evaluations are automatically deleted.

You can reset the evaluations at any time. All evaluations are then automatically deleted.

► Use the  or  button to scroll to  driving mode.

► Press the  or  button to scroll to the **FleetBoard EcoSupport** menu window.

► **To display evaluations:** press the  button. The menu window shows the following categories:

- **Evenly** The on-board computer evaluates your constant vehicle speed over a prolonged period.
- **Roll/brake** The on-board computer evaluates the braking phases that do not lead to the vehicle coming to a standstill. It evaluates whether you decelerate the vehicle by rolling or by applying the brakes (engine brake/retarder and service brake). The most economical process for reducing kinetic energy is:
 - deceleration by rolling
 - deceleration with the engine brake/retarder
 - deceleration with the service brake

If you often reduce the vehicle speed by rolling, you receive a positive evaluation.

- **Stop** The on-board computer evaluates the braking phases that lead to the vehicle coming to a standstill. If you drive carefully and therefore avoid having to bring the vehicle to a standstill, you receive a positive evaluation.
- **Speed** The on-board computer evaluates excessive vehicle speeds. If you drive above approximately 85 km/h, you receive a negative evaluation.
- **Use of cont. brake** The on-board computer evaluates the use of the continuous brake and a careful, incremental activation of the brake stages.
- **Shift** The on-board computer evaluates whether you observe the gearshift recommendations in the on-board computer, and which drive program you have selected. If, for example, you drive in the fuel-saving **A economy** gearshift program, you receive a positive evaluation.
- **Use of acc. pedal** The on-board computer evaluates your accelerator usage, as well as the use of the kickdown function. A gentle and constant accelerator usage is evaluated positively.
- **Truck check** The on-board computer evaluates:
 - the engine run time when the vehicle is stationary

If you leave the engine running for approximately 1 minute for no discernible reason when the vehicle is stationary, you receive a negative evaluation. If, for example, you switch off the engine while in stationary traffic, you receive a positive evaluation.

- the tyre pressure (vehicles with tyre pressure monitor)

If the tyre pressures are too low when driving, you receive a negative evaluation.
- the regeneration of the diesel particle filter

If you do not carry out a scheduled regeneration of the diesel particle filter, you receive a negative evaluation.
- the maintenance of the air filter

If you exceed the air filter maintenance due date, you receive a negative evaluation.

- ▶ Press the or button to select the category.

In the corresponding category, the menu window displays:

 - the average evaluation score, e.g. **Ø 25%**
 - a bar display with the current evaluation
 - a message on the current evaluation, e.g. **Even driving**
- ▶ **To reset evaluations:** press the button.

The input window displays the **Reset evaluation? Yes/No** message.
- ▶ Use the or button to select **Yes** and press or to confirm.

Navigation menu window

The **Navigation** menu window is available on vehicles with the truck navigation system.

- ▶ Use the or button to scroll to driving mode.
- ▶ **To display route guidance:** use the or button to scroll to the **Navigation** menu window.

The menu window shows:

 - the destination, the street name
 - the direction of travel
 - the distance to the next change of direction

Assistance menu window

The **Assistance** menu window is available on vehicles with distance control assistant and/or Lane Keeping Assist. The on-board computer displays warnings and the status of the driving systems in colour. Please read the operating instructions on the distance control assistant (▷ page 278) and Lane Keeping Assist first (▷ page 290)

- ▶ Switch on the distance control assistant and/or Lane Keeping Assist.
- ▶ Use the or button to scroll to driving mode.
- ▶ **To show distance, speed and lane markings:** use the or button to scroll to the **Assistance** menu window.

The menu window shows:

- the vehicle speed of the detected vehicle and the distance to the detected vehicle (distance control assistant)
- the lane markings (Lane Keeping Assist)

Backup drive mode menu window











General notes

If the automated transmission shift system is malfunctioning, you may, under certain circumstances, be able to continue your journey in backup drive mode. It is not possible to change gear in backup drive mode when the vehicle is in motion.

The vehicle may respond abnormally in backup drive mode and therefore requires a high level of concentration on the part of the driver.

Backup drive mode remains switched on for as long as the ignition lock is in the drive position. When you take the key out of the ignition lock, backup drive mode is switched off. If backup drive mode is used when the transmission is cold, the on-board computer may not show the selected gear. Repeat the gear selection. If the on-board computer does not display the selected gear after you have tried to select a gear several times, switch off the engine. Start the engine again and select the gear.

Selecting a shift position

- ▶ Apply the parking brake.
- ▶ Start the engine.
- ▶ Use the  or  button to scroll to  driving mode.
- ▶ Use the  or  button to scroll to the **Backup drive mode** menu window. The menu window shows the **Activate with "OK"** message.
- ▶ Press the  button. The menu window shows the **Engage parking brake** message.
- ▶ Press the  button. The input window shows:
 - **R** for reverse gear
 - **N** for neutral
 - **D1** for the slow gear, 2nd gear
 - **D2** for the fast gear, 6th gear
 -  for towing mode
- ▶ Select the desired gear, neutral position or towing mode with the  or  button

and confirm your selection with the  button.

The on-board computer displays the selected direction of travel in the status area.











- ▶ When the menu window shows the **Ready to start for 10 seconds** message, depress the accelerator pedal.

If you are driving in backup drive mode, **Shift to neutral?** appears in the event window. You can only shift to neutral position if the vehicle is in motion.

You can find information on towing in the section "Manoeuvring, tow-starting and towing away" (▷ page 397).

Video menu window

The **Video** menu window is available for vehicles fitted with a reversing camera without a Bluetooth® radio/navigation system, Comfort.



- ▶ Use the  or  button to scroll to  driving mode.
- ▶ **To display the camera image:** use the  or  button to scroll to the **Video** menu window. The display in the instrument cluster displays the camera image.
- ▶ **To adjust the brightness/contrast:** press . By means of a bar display, the input window displays the set brightness.
- ▶ Select the bar display for brightness/contrast using the  or  button.
- ▶ Adjust the brightness/contrast of the camera image using the  or  button.

Information on operating the reversing camera for vehicles with a Bluetooth® radio/navigation system, Comfort, can be found in the "Audio systems" section (▷ page 216).



Audio and communications menu

Alarm clock menu window

If your vehicle is equipped with Mercedes-Benz audio equipment, you can set the radio as an alarm in alarm mode. If the alarm mode is set to **Radio** and the audio equipment is switched on at the set alarm time, no further signalling takes place.

- ▶ **To display alarm time:** use the  or  button to scroll to  audio and communications.



The menu window shows:



- the day of the week and the date
- the alarm time for alarm clock 
- the alarm time for alarm clock 



- ▶ **To set the alarm clock:** press the  button.

The input window shows:

- the alarm clock **Alarm clock 1/Alarm clock 2**
- the alarm mode **Audio/Buzzer/Off**
- the hour of the alarm time, e.g. **09 h**
- the minute of the alarm time, e.g. **23 min**

- ▶ Select the desired menu bar with the  or  button.

- ▶ Change the value with the  or  button.

- i** If you press and hold  or , the hours/minutes scroll quickly.

- ▶ **To stop the alarm:** press the  button.

- i** The alarm switches off automatically after 2 minutes.

Telephone menu window

Important safety notes

WARNING

If you use mobile information systems and communications devices while driving, you will be distracted from traffic conditions. You could then lose control of the vehicle. There is a risk of an accident.

Only operate these devices when the vehicle is stationary.

Functions

The telephone menu window is available on vehicles with:

- CD radio with Bluetooth®
- CD radio Comfort with Bluetooth®
- Radio/navigation system, Bluetooth®, Comfort

In the telephone menu window you can:

- display the phone book, select and call an entry
- display the list of callers, select and call an entry
- update the phone book

- i** Further information on suitable mobile phones and on connecting mobile phones via Bluetooth® can be obtained:

- at your Mercedes-Benz Service Centre
- on the Internet at <http://www.mercedes-benz.com/connectivity>

- ▶ Bluetooth® mobile phone: connect the mobile phone with the audio equipment.

- ▶ Use the  or  button to scroll to  audio and communications.

- ▶ Use the  or  button to scroll to the **Telephone** menu window.



- ▶ The menu window shows the name of the provider and the name of the connected Bluetooth® mobile phone.

- i** Pressing the  button briefly calls up the **Telephone** menu directly.



- ▶ **To display the phone book/call list:** press .



The input window shows:



- **Phone book**
- **Missed calls**
- **Received calls**
- **Numbers dialled**
- **Load phone book**

- ▶ Select the desired menu bar with the  or  button.

- ▶ Use the  button to display the entries.





- ▶ Select a name or number with the  or  button.

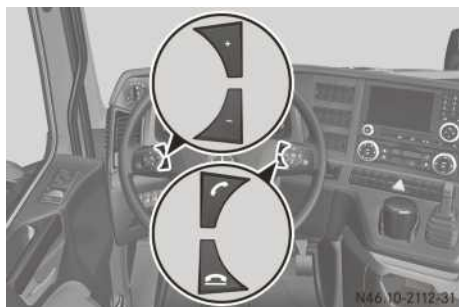



- i** By pressing and holding the  or  button, you can quickly scroll through the telephone book or the missed calls list.

- i** To call the number in the telephone book or a missed calls list, press . The menu window first displays details about the call. Pressing the  button again dials the phone number.



Example







-  Makes or accepts a call/displays **Telephone** menu window
-  Ends or rejects a call
-  Increases the volume
-  Decreases the volume





- ▶ **To accept a call:** press the  button. The on-board computer shows the caller's number or **Unknown number**.
- ▶ **To adjust the call volume:** increase or decrease the volume during the call with the  or  button.
- ▶ **To reject or end a call:** press the  button.

Audio menu window

Audio source, title/station/frequency, MP3 browser











The **Audio** menu window is available on vehicles with Mercedes-Benz audio equipment.

- ▶ Switch on the audio equipment (▷ page 216).
- ▶ Use the  or  button to scroll to  audio and communications.
- ▶ **To display the audio source and the title/station:** use the  or  button to scroll to the **Audio** menu window.
- ▶ **To change the audio source or title/station/frequency:** press the  button. Depending on the active audio source, the input window displays:
 - the name of the audio source
 - the station or frequency when in radio mode
 - the title when in CD, USB or Bluetooth® mode
 - the AUX source when in audio AUX mode

- the waveband when in radio mode
 - the MP3 browser when in CD or USB mode
- ▶ Select the desired menu bar with the  or  buttons.
 - ▶ Change the audio source, track or station with the  or  buttons.

For MP3 files on audio CDs or on USB storage devices, you can navigate in the folders and play MP3 files.

Operating the MP3 browser

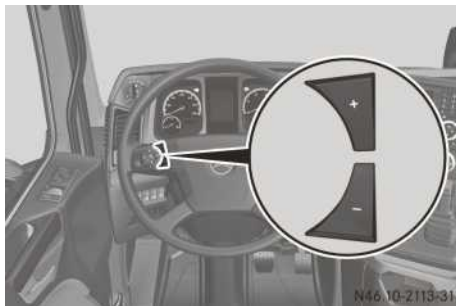

- ▶ Open the **Audio** menu window.
- ▶ Press the  button.
- ▶ Press the  or  button to select the MP3 browser menu bar.
- ▶ **To open the MP3 browser:** press the  or  button.
- ▶ **To switch between MP3 files/folders:** press the  or  button.
- ▶ **To select an MP3 file or to open a folder:** press the  button.
- ▶ **To close the current folder:** briefly press the  button.
- ▶ **To close the MP3 browser:** press and hold the  button.

Adjusting the volume



Example

In audio mode, you can adjust the volume at any time.













- ▶ **To increase or decrease the volume:** press  or .



Mobile devices menu window

Mobile devices are smartphones or tablets, for example. If your vehicle is equipped with the "Remote Online" function, authorise devices to access the vehicle's network (Wi-Fi) via the











menu. To do this, the Truck-App must be installed on the mobile device.

Further information on the "Remote Online" function and on the Truck-App can be found under "Communication" (▷ page 112).

- ▶ Use the  or  button to scroll to  audio and communications.
- ▶ Use the  or  button, to scroll to the **Mobile devices** menu window. The menu window shows .
- ▶ Press the  button. The input window shows both mobile device options:
 - to authorise for access to the vehicle's network (Wi-Fi)
 - to remove from the list of authorised devices
- ▶ **To connect a mobile device:** use the  or  buttons to select **Connect**. The input window **Connect devices** shows:
 - **Network name:** Name of the vehicle's network (Wi-Fi)
 - **Network key:** Wi-Fi password for authentication for entry in the mobile device for network registration
 - **Network session:** PIN to identify the mobile device for entry via the Truck-App
- ▶ Mobile device: connect the device to the vehicle's network (Wi-Fi) (see the manufacturer's operating instructions).
- ▶ Mobile device: in the Truck-App's pairing menu, add a new vehicle and enter the PIN for the network session.
- ▶ Press the  button. The on-board computer display shows a message if the device has successfully been connected to the vehicle's network.
- ▶ Press the  button. If the mobile device could not be connected successfully, repeat the process.
- ▶ **To remove a mobile device:** use the  or  button to select **Remove**. The **Remove devices** input window shows the list of names for the authorised mobile devices and the **All devices** option.

- ▶ To remove all authorised devices, use the  or  button to select **All devices** and confirm with the  button. The input window shows the confirmation prompt **Are you sure you want to remove? No/Yes**.

or

- ▶ Use the  or  button to select the mobile device to be deleted and confirm with the  button. The following input window shows the Name and a Detail, e.g. the network address, to identify the mobile device. The device selection must be confirmed with the  or  button. Afterwards, the next input window shows the confirmation prompt **Are you sure you want to remove? No/Yes**.
- ▶ Use the  or  button to select **Yes** and press  or  to confirm. The on-board computer display shows a message if the device has successfully been removed from the vehicle's list of authorised devices.
- ▶ Press the  button. If the mobile device could not be removed, repeat the process.



Operation and maintenance menu

Axles menu window

Displaying the axle loads









Vehicles with air suspension: the vehicle may be equipped with an axle load indicator. The axle load indicator is not calibrated, nor is it a system capable of calibration. The measured data only provides an approximate guide. The values are not suitable for official use. In order to avoid inaccuracies in the measurement, make sure that the vehicle is uniformly laden.

When the chassis is at driving level, the axle load measuring system determines the axle load from the pressure in the air spring bellows.

- ▶ Park the vehicle on a level surface.
- ▶ Apply the parking brake.
- ▶ Set the driving level (▷ page 298).
- ▶ Using the  or  button, scroll to  operation and maintenance. The menu window shows the vehicle axles and the axle load.

Setting the axle load indicator

You can adjust the axle load indicator if there is a notable difference between the axle load indicator and the weighbridge results.

- ▶ Park the vehicle on a level surface.
- ▶ Apply the parking brake.
- ▶ Switch off the starting-off aid (▷ page 300).
- ▶ Set the driving level (▷ page 298).
- ▶ Drive the vehicle onto the single axle weighbridge.
- ▶ Using the  or  button, scroll to  operation and maintenance. The menu window shows the axle loads and the overall axle load.
- ▶ Press the  button. The input window shows the axle loads.
- ▶ Select the desired axle with the  or  button.
- ▶ Using the  or  button, correct the axle load according to the value shown by the single axle load measuring device.

Tyres menu window

Function and notes on the tyre pressure monitor

WARNING

Underinflated or overinflated tyres pose the following risks:

- the tyres may burst, especially as the load and vehicle speed increase.
- the tyres may wear excessively and/or unevenly, which may greatly impair tyre traction.
- the driving characteristics, as well as steering and braking, may be greatly impaired.

There is a risk of an accident.

Observe the recommended tyre pressure and check the tyre pressure of all the tyres including the spare wheel:

- at least once a month
- when the load changes
- before embarking on a longer journey
- for changed operating conditions, e.g. off-road driving.

If necessary, correct the tyre pressure.

The **Tyres** menu window is available on vehicles with the tyre pressure monitor system.

The tyre pressure monitor is a convenience system that:

- assists you in checking your tyre pressures regularly and
- automatically warns of tyre pressure loss

The tyre pressure monitor can only provide reliable warnings if the correct specific pressure for the tyres has been set in the on-board computer.

The tyre pressure monitor detects an incorrect value if, for example:

- your vehicle is overloaded or incorrectly loaded
- the vehicle is fitted with wheels which have different tyre sizes and the specified pressure in the on-board computer has not been corrected
- an incorrect specified pressure has been set in the on-board computer

You are always responsible for setting the correct tyre pressure. Always have the correct specified pressure set in the on-board computer at a qualified specialist workshop.

i For every 10 °C change in air temperature, the tyre pressure changes by around 30 to 40 kPa (0.3 to 0.4 bar/4.4 to 5.8 psi). Bear this temperature-related change in tyre pressure in mind when checking tyre pressures indoors, where the temperature may be higher than the outside temperature.

Example:

- room temperature is approximately 20 °C
- outside temperature is approximately 0 °C
- set the tyre pressure to around 60 to 80 kPa (0.6 to 0.8 bar/8.7 to 11.6 psi) above that prescribed in the tyre pressure table

Note also the important safety notes in the "Tyres and wheels" section (▷ page 404).

If you are using tyres with a different load bearing index or tyres of a different size, have the specified pressure adjusted accordingly in a qualified specialist workshop.

The tyre pressure monitor system monitors the tyre pressure of all the tyres of the tractor vehicle both when stationary and when the vehicle is in motion.

i If your trailer is equipped with a tyre pressure monitor, the trailer tyres are also moni-

tored and displayed in the **Trailer** menu window (▷ page 147).

If radio transmitting equipment (e.g. cordless headphones, two-way radios) is operated inside the vehicle or in the vicinity of the vehicle, this can interfere with the operation of the tyre pressure monitor.

The on-board computer displays "-" instead of the respective tyre pressure if:

- a tyre pressure sensor is temporarily malfunctioning, e.g. due to radio transmitting equipment
- values from the tyre pressure sensor are not yet available

Wait a few minutes and/or move the vehicle out of the operating range of the radio transmitting equipment.

The tyre pressure values in the on-board computer may differ from those measured with a tyre pressure checker. The tyre pressures displayed by the on-board computer refer to sea level. When at high altitudes, tyre pressure checkers show higher pressures than the on-board computer. If this is the case, do not reduce the tyre pressure.







The tyre pressure monitor automatically recognises new wheels or tyre pressure sensors.

After replacing the tyre pressure sensors, the vehicle should remain stationary for 15 minutes. Afterwards, drive the vehicle at a speed of over 30 km/h for at least 10 minutes.

Displaying tyre pressure

i If your vehicle is equipped with a multifunction key, you can also check the tyre pressure on the display of the multifunction key (▷ page 58).

If your vehicle is equipped with the "Remote Online" function, you can also check the tyre pressures in the Truck-App (▷ page 112).

- ▶ Using the  or  button, scroll to  operation and maintenance.
 - ▶ Using the  or  button, scroll to the **Tyres** menu window.
- The menu window displays the tyre pressures for all of the tractor vehicle's tyres.
- ▶ Press the  button.

The input window shows:



- the battery status of the tyre pressure sensor for the tyres on this axle
- the selected axle, e.g. **Axle 1**

- the tyre pressures and temperatures for the tyres on this axle
- depending on the equipment
 - the specified pressure for the tyres on this axle (at 20 °C)
 - the target pressure for each tyre depending on the tyre's temperature



- ① Axles
- ② Target pressure

i When the tyre temperature differs, different target pressures may be shown for the tyres, e.g. because of exposure to sunlight.

- ▶ Scroll to the next axle using the  or  button.

Tyre pressure loss warning

If the tyre pressure of one or more tyres drops, the on-board computer displays the  warning in a yellow or red event window. A warning tone also sounds. Each tyre pressure value for which a loss of pressure has been determined is highlighted in red or yellow. When there is a notable loss of tyre pressure, the tyre pressure value is shown in red.

Level control menu window

Important safety notes

When driving with a lowered or raised chassis, the driving and braking characteristics may be affected. Additionally, the maximum permitted vehicle height may be exceeded when the chassis is raised. Observe the legally permissible

vehicle heights for the country you are currently in.

Set the driving level before pulling away.







It is necessary to raise/lower the chassis to pick up/set down demountable bodies or semitrailers. If you continue a journey after having changed the chassis height, it is necessary to lower/raise the chassis to driving level.

If the yellow  indicator lamp in the instrument cluster lights up, the chassis is not at driving level. Observe the additional information in the event window.

Adjusting the level control

The **Level control** menu window is available on vehicles with air suspension. You can operate the level control when the vehicle is stationary or when the vehicle is in motion up to approximately 30 km/h.





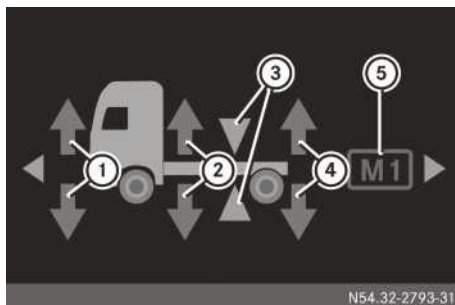









Depending on your vehicle's equipment, you control the function of the level control system using:





- the control panel on the driver's seat (▷ page 295)
 - the external control panel on the vehicle body (▷ page 295)
 - the multifunction key (▷ page 58)
 - the Truck-App on a mobile device (▷ page 112)
 - the on-board computer
- ▶ Using the  or  button, scroll to  operation and maintenance.
- ▶ Using the  or  button, scroll to the **Level control** menu window.
- ▶ Press the  button.
The on-board computer displays the input window.



Example: level control input window

- ① Preselection: to raise/lower the front axle
- ② Preselection: to raise/lower the entire vehicle
- ③ Preselection: to set the driving level
- ④ Preselection: to raise/lower the rear axle
- ⑤ Memory position M1 or M2 for chassis height

- ▶ **To raise/lower the chassis:** using the  or  button, select front axle ①, entire vehicle ② or rear axle ④.
- ▶ Press the  button to lower the chassis or the  button to raise it. The  indicator lamp in the instrument cluster lights up.
- ▶ **To interrupt/end the raising or lowering operation:** press the  button.
- ▶ **To select the driving level:** use the  or  button to select preselection driving level ③.
- ▶ Briefly press the  or  button.
The chassis is raised or lowered automatically to the driving level.
When the chassis is at driving level, the  indicator lamp in the instrument cluster goes out.
- ▶ **To store the chassis height:** raise or lower the chassis to the desired height.
- ▶ Using the  or  button, select memory position M1 or M2 for chassis height ⑤.
- ▶ Press the  button for approximately 2 seconds.
The current height of the chassis frame is stored under the corresponding memory position M1 or M2.









- ▶ **To call up the chassis height:** using the  or  button, select memory position M1 or M2 for chassis height .
- ▶ Call up the selected memory position by pressing . The chassis will be raised/lowered automatically to the stored height.

You can find more information about level control in the "Driving mode" section (▶ page 295).

Trailer/semitrailer menu window

The **Trailer** menu window is available when a trailer/semitrailer is coupled up. The possible displays depend on your trailer/semitrailer's equipment. Observe the notes on equipment and their operation in the manufacturer's operating instructions for the trailer/semitrailer.

If the axle load is displayed in the **Trailer** menu window, park the vehicle on a level surface and apply the parking brake.

- ▶ Use the  or  button to scroll to  operation and maintenance.
- ▶ Using the  or  button, scroll to the **Trailer** menu window.
- ▶ Press the  button. The display shows the first input window, e.g. **Brake info**.
- ▶ Display the next input window with the  or  button. The following information/input windows may be displayed, depending on the equipment installed:
 - **Brake info** displays the temperature and the wear of the trailer/semitrailer brake
 - **Axle loads** displays the overall axle load of the trailer/semitrailer
 - **Tyres** displays the tyre pressure of the trailer/semitrailer tyres
 - **Reserve pressure** displays the reservoir pressure in the trailer/semitrailer compressed-air reservoir
 - **Sideguard Assist trailer monitoring** displays the Sideguard Assist trailer monitoring setting. In addition, you can switch the trailer monitoring of Sideguard Assist on or off.

Maintenance menu window







- ▶ **If you confirm maintenance work, without having it performed according to schedule, you can damage the vehicle and the assemblies. Wear can increase.**

If you inadvertently confirm maintenance work or confirm it too early, the maintenance system calculates the new maintenance due date. To prevent damage to the vehicle or assemblies, have the corresponding maintenance work performed immediately.

Only confirm the maintenance work when the maintenance work has been performed.

The maintenance system calculates maintenance due dates for the vehicle and its assemblies based on the vehicle's operating conditions. The event window automatically displays maintenance due dates 14 days in advance. When the maintenance due date has been reached or exceeded, the on-board computer shows additional event windows (▶ page 161).

If the maintenance work is carried out at a Mercedes-Benz Service Centre, the fact that the work has been carried out professionally will be confirmed in the on-board computer and the service report.



- ▶ Using the  or  button, scroll to  operation and maintenance.
- ▶ Using the  or  button, scroll to the **Maintenance** menu window.
- ▶ **To display the maintenance point and due date:** press the  button.

The input window shows, for example:







- the maintenance point **Engine**
- the maintenance due date **23.09.2014**
- the remaining distance **2000 km**

If no prediction for the maintenance due date is possible, the input window shows, for example:

- the maintenance point **Engine**
- the maintenance due date **--.---.---**





- ▶ **To display the next maintenance point and due date:** use the  or  button to display the next maintenance point. Depending on the vehicle's equipment, you can call up the following maintenance points, for example:
 - **Time-based maint.**
 - **Engine**
 - **Diesel particle filter**

- Rear axle
- Transmission
- Brakes, axle 1/2/3/4/5
- Air filter





- ▶ **To reset the maintenance due date:** press the  or  button to display the desired maintenance point. If a reset is possible, the input window shows **Reset?**.
- ▶ Press the  button. The input window shows **No/Yes**.
- ▶ Use the  button to select the **Yes** menu bar and press the  or  button to confirm.

Monitoring info menu

Reservoir pressure menu window

- ▶ **To display the reservoir pressure:** use the  or  button to scroll to  monitoring info. The menu window shows the reservoir pressure of brake circuits  and  as a bar display.

Coolant menu window

- ▶ Use the  or  button to scroll to  monitoring info.
- ▶ **To display the coolant temperature:** use the  or  button to scroll to the **Coolant** menu window.







If the coolant level is too low, the coolant temperature cannot be displayed.

Engine menu window

In the **Engine** menu window, you can check the engine oil level and display the engine's operating hours. Check the engine oil level before the start of every journey. The engine oil level is not displayed while driving.

- ▶ Park the vehicle on a level surface.
- ▶ Apply the parking brake.
- ▶ Switch off the engine.
- ▶ Switch the ignition lock to the drive position.
- ▶ Wait at least 5 minutes after switching off the engine.

i If you call up the oil level too early or while the engine is running, **Not available** appears in the menu window.









- ▶ Use the  or  button to scroll to  monitoring info.
- ▶ **To display the engine oil level and operating hours:** use the  or  button to scroll to the **Engine** menu window. The menu window shows:
 - the engine oil level , e.g. **Oil level ok** or **Oil level low** and/or **Top up oil: 4 l**
 - the  operating hours of the engine, e.g. **10000 h 27 min**

The service counter is not suitable for measuring the driving hours of the driver. Use equipment which is suitable for this purpose.

- ▶ When the menu window displays **Oil level low** or **Oil level too low**, do not start the engine. Immediately top up the amount of oil shown (▶ page 360) and check the oil level again. If the menu window shows **Oil level ok** and **Top up oil: 3 l**, the engine oil level is sufficient. The amount of oil to top up to reach the maximum fill level is purely for your information. At the moment, you do not need to top up the oil.
- ▶ If the oil level display is not available, repeat the oil level check.
- ▶ If it is not possible to display the oil level after repeated attempts, have the oil level display checked at a qualified specialist workshop.

Events menu window









You can display stored malfunctions and messages in the **Events** menu. If you have rectified the cause of the malfunction/message, the on-board computer no longer displays the event.

- ▶ Use the  or  button to scroll to  monitoring info.
- ▶ Use the  or  button to scroll to the **Events** menu window. The menu window shows, for example, the number of events.
- ▶ **To display an event:** press .
- ▶ **To show further events:** press the  or  button.

Diagnostics menu window

Diagnostics data contains information with which you can assist the workshop staff during fault diagnosis, e.g. by remote diagnosis. The **Diagnosis** menu window contains, for example, a list of all control units (systems) installed in the vehicle.









You can obtain further information from any Mercedes-Benz Service Centre.

- ▶ Use the  or  button to scroll to  monitoring info.
- ▶ Use the  or  button to scroll to the **Diagnosis** menu window.
- ▶ **To display diagnostics data:** press . The input window shows a list of all control unit system abbreviations.
- ▶ Select the desired control unit using the  or  button.
- ▶ Display further details on the control unit by pressing the  button.

Settings menu















Menu window menu



If you change the settings in the **Menu** menu window, the changes affect the display of the menu window.

- ▶ Use the  or  button to scroll to  settings.
- ▶ **To set the units of measurement:** press the  button. The input window displays a list of possible settings:
 - clock mode in **24h** or **12h**
 - speed in **km/h** or **mph**
 - distance in **km** or **mi**
 - liquid units in **litres**, **UK gal** or **US gal**
 - temperature units in **°C** or **°F**
 - average fuel consumption in **l/100 km**, **km/l** or **mpg**
 - pressure units in **bar/kpa** or **psi**
 - weight units in **t**, **tn** or **l.tn**
- ▶ Select the desired menu bar with the  or  button.
- ▶ Change the setting with the  or  button.

Lighting menu window

In the lighting menu window you can:

- adjust the headlamp range of the dipped-beam headlamps
- adjust the brightness of the instrument cluster lighting and audio display, when it is dark and the lights are switched on
- set the delayed switch-off of the exterior lighting (dipped-beam headlamps and foglamp) for the surround lighting
- switch the automatic control of the interior lighting on/off
- switch the nightlight (green) on/off
- ▶ Use the  or  button to scroll to  settings.
- ▶ Use the  or  button to scroll to the **Lighting** menu window.
- ▶ Press the  button. The menu window shows the **Headl. range ctrl.** input window.
- ▶ **To adjust the headlamp range of the dipped-beam headlamps:** change the setting using the  or  button. When the vehicle is laden, the road should be illuminated from 40 m to 100 m and the dipped-beam headlamps must not dazzle oncoming vehicles. If the vehicle is unladen, select position **0**.
- ▶ **To set the instrument cluster lighting:** use the  or  button to select **Instrument panel**. If the light is switched off and night mode has not been detected, the input window shows **Day mode**. Changing the settings is then no longer possible. Otherwise, the input window shows the brightness of the instrument cluster lighting and of the audio display as a bar display.
- ▶ Change the setting with the  or  button.
- ▶ **To set the delayed switch-off of the exterior lighting:** use the  or  button to select **Delay switch-off, ext. lighting**. The input window shows the delayed switch-off time set for the exterior lighting (dipped-beam headlamps and foglamp) for the surround lighting.

- ▶ Change the setting with the  or  button.



If you set the delayed switch-off to **0 s**, the surround lighting is switched off.

Vehicles with rain and light sensor: surround lighting is switched on for the delayed switch-off time set if you:

- unlock the vehicle with the remote control in the dark
- open a door in the dark

Vehicles without rain and light sensor: surround lighting is switched on for the delayed switch-off time set if you:

- unlock the vehicle with the remote control
- switch off the dipped-beam headlamps or side lamps, switch off the ignition and open a door within approximately 4 minutes

- ▶ **To switch the automatic control of the interior lighting on/off:** use the  or  button to select **Automatic interior light control**.

i Depending on the equipment, the menu item may not be available.

- ▶ Press the  or  button to activate or deactivate automatic control.

The interior lights and the entrance lighting switch on automatically if the automatic control is switched on and you open a door. You will find further information on automatic control of the interior lighting under "Interior lighting" (▷ page 90).

- ▶ **To switch the nightlight on/off:** use the  or  button to select **Nightlight**.

i The nightlight is used as non-dazzle courtesy lighting while driving.

Depending on the equipment, the menu item may not be available.

- ▶ Press the  or  button to activate or deactivate the nightlight.

If you select the **Auto** setting, the nightlight will automatically switch on when the dipped-beam headlamps have been switched on.

Language menu window



The languages available depend on the country in which the vehicle is sold. All text displays are shown in the set language. You can install more languages.

Information on installing more languages can be obtained from any Mercedes-Benz Service Centre.

- ▶ Use the  or  button to scroll to  settings.

- ▶ Use the  or  button to scroll to the **Language** menu window.

- ▶ **To set the language:** press the  button. The input window displays a selection of languages.

- ▶ Select the desired language with the  or  button.

- ▶ Change the setting with the  button.

Service products menu window

General notes

- !** When you change the service product data via the on-board computer, the maintenance system adjusts the maintenance due dates accordingly.

Set the data for the service products added. Otherwise, the assemblies could be damaged.

Observe the information under "Service products" (▷ page 4 18).

Engine fuel grade

- !** A high fuel sulphur content accelerates the ageing process of the engine oil and can damage the engine and exhaust system.

Before delivery, the fuel sulphur content is set to the standard of the country of delivery or the permissible fuel sulphur content for BlueTec® vehicles.

Observe the notes on diesel fuel and fuel grade in the "Diesel fuel" section (▷ page 422).

Engine oil viscosity

Set the viscosity classification (SAE class) of the engine oil used under **Engine Oil viscosity**.

Engine oil grade

- !** If you mix engine oils with differing oil grades, the change interval for the engine oil is reduced in comparison to mixtures of engine oil of identical grade.

Therefore, only mix engine oils of differing grade in exceptional circumstances. To prevent damage to the engine, set the sheet

number of the engine oil with the lower grade under [Engine oil grade](#).

Observe the information under "Engine oils" (▷ page 419).

Set the oil grade of the engine oil used according to the Sheet Numbers of the Mercedes-Benz Specifications for Service Products under [Engine Oil grade](#).

- i** You can obtain information about service products that have been tested by Mercedes-Benz and approved for your vehicle on the Internet at: <http://bevo.mercedes-benz.com/>













Transmission oil grade

Set the oil grade of the transmission oil used according to the Sheet Numbers of the Mercedes-Benz Specifications for Service Products under [Transmission Oil grade](#).

Rear axle oil grade

Set the oil grade of the transmission oil used according to the Sheet Numbers of the Mercedes-Benz Specifications for Service Products under [Rear axle Oil grade](#).

Setting the service products

- ▶ Use the  or  button to scroll to  settings.
- ▶ Use the  or  button to scroll to the [Service products](#) menu window.
- ▶ Press the  button.
The input window displays the assembly and the service product characteristic, for example [Engine Oil grade](#), as well as the currently set value, e.g. [228.51](#).
- ▶ **To select an assembly:** using the  or  button, select an assembly with a corresponding service product characteristic, for example:
 - [Engine Fuel grade](#)
 - [Engine Oil viscosity](#)
 - [Engine Oil grade](#)
 - [Transmission Oil grade](#)
 - [Rear axle Oil grade](#)
- ▶ **To set the service product value:** using the  or  button, select a service product value.
- ▶ Set the service product value of the service product added using the  or  button.

Systems menu window

Information on controlling regeneration of the diesel particle filter can be found under:

- Regeneration block (▷ page 312)
- Starting manual regeneration (▷ page 312)









You will find information about the drive functions in the automated manual transmission under:

- Rocking-free (▷ page 258)
- Crawler mode (▷ page 257)
- Hydromove (vehicles with a hydrodynamic clutch)
- EcoRoll mode (▷ page 256)

Information on the driving systems can be found under:

- ATTENTION ASSIST (▷ page 291)
- Sideguard Assist (▷ page 292)
- PPC (Predictive Powertrain Control) (▷ page 282)

Using the [Video popup](#) function you can set whether the image from the reversing camera is automatically displayed if reverse gear is engaged. You can adjust the image from the reversing camera in the  driving mode menu in the [Video](#) menu window (▷ page 140).

- ▶ Use the  or  button to scroll to  settings.
- ▶ Use the  or  button to scroll to the [Systems](#) menu window.
- ▶ **To switch the function or driving system on/off:** press the  button.
- ▶ Use the  or  button to select the function or driving system.
- ▶ Press the  button to activate/deactivate.

If you switch the ignition lock to position **0** for several seconds, the following vehicle systems are automatically activated again:

- Crawler mode
- EcoRoll mode
- ATTENTION ASSIST

PPC and the regeneration block of the diesel particle filter stay on or off even after the ignition has been switched on again.

On-board computer event window

Notes on events

Messages include operating information, error messages or warnings that the on-board computer automatically displays in an event window. In addition to the event window, an indicator lamp may light up in the instrument cluster or in the status area of the on-board computer. Depending on the priority of the message, the on-board computer displays the event window in different colours:

- **grey event window for a malfunction/ notification of low priority**



Observe the instructions in the event window. You can drive on.

- **yellow event window for a malfunction/ notification of medium priority**

Observe the instructions in the event window. If it is possible to continue the journey despite the malfunction, drive on carefully. Have the affected system checked at a qualified specialist workshop as soon as possible.

- **red event window for a malfunction of high priority**

Observe the instructions in the event window. Immediately stop the vehicle while paying attention to the traffic conditions and contact a qualified specialist workshop. If the qualified specialist workshop determines it is possible to continue driving, adapt your driving style accordingly. Drive with even greater care. Keep in mind that continuing the journey could damage the vehicle and contravene legal regulations. Immediately drive to a qualified specialist workshop and have the affected system checked and repaired.

If you can confirm the event window using the  button, the event window is hidden. You can call up the event window again at a later point ( page 148). If in addition to the event window, an ( page 134) indicator lamp has lit up in the instrument cluster or in the status area of the on-board computer, the indicator lamp remains on.



Grey event window

Notes





Important safety notes

If you ignore warning and indicator lamps and the event window, you will not be able to recognise failures and malfunctions in components or systems. Driving/braking characteristics may be affected and the operating and road safety of your vehicle may be limited. Have the affected system checked and repaired at a qualified specialist workshop. Always observe the warning lamps and event window and follow the corresponding measures.









Grey event window

With a malfunction/notification of low priority, the on-board computer displays a grey event window. If further information about the malfunction/notification is available, the event window displays the  symbol. You can display the information using the  button on the multifunction steering wheel. Observe the information and instructions in the event window. You can drive on.





BlueTec® exhaust gas aftertreatment

Display messages	Possible causes/consequences and ► Solutions
 <p>Engine speed increase</p>	<p>The "HC burn-off" feature reduces deposits of hydrocarbons in the catalytic converter. This is done by increasing the engine speed. The process cannot be cancelled once the message has appeared.</p> <p>When the process is completed, the message disappears automatically.</p> <p>"HC burn-off" does not regenerate the diesel particle filter.</p>
 <p>Regeneration disabled</p>	<p>Regeneration of the diesel particle filter is disabled and the fill level of the diesel particle filter is raised.</p> <ul style="list-style-type: none"> ► In order to enable automatic regeneration of the diesel particle filter, deactivate the regeneration block as soon as possible (▷ page 312).
 <p>Manual regeneration not possible</p>	<p>Supplementary text : Requirements for manual regeneration have not been fulfilled. Please observe Operating Instructions.</p> <p>Regeneration of the diesel particle filter is not possible. One or more requirements have not been fulfilled.</p> <ul style="list-style-type: none"> ► Observe the activation conditions and requirements for manual regeneration of the diesel particle filter (▷ page 312).



Transmission and clutch

Display messages	Possible causes/consequences and ► Solutions
 <p>Clutch under heavy strain</p>	<p>The clutch is under a heavy load but not overloaded. You should only pull away in first gear.</p> <ul style="list-style-type: none"> ► Keep the pulling away or manoeuvring procedure as brief as possible.
 <p>Press shunting switch for longer</p>	<p>You have pressed the  switch for manoeuvring mode too briefly.</p> <ul style="list-style-type: none"> ► Press the  switch again.
 <p>Press shunting switch faster</p>	<p>If the event window turns off again, you have pressed the  switch for manoeuvring mode for too long. If the event window stays on, the  switch is malfunctioning.</p> <ul style="list-style-type: none"> ► Press the  switch again. <p>or</p> <ul style="list-style-type: none"> ► Have the  switch checked at a qualified specialist workshop.









Driving systems

Display messages	Possible causes/consequences and ► Solutions
 <p>Active Brake Assist cannot be activated</p>	<p>ABS may be switched off. There may be a fault in Active Brake Assist or a fault with the vehicle's brake system.</p> <p> WARNING</p> <p>If Active Brake Assist cannot be activated, you will not receive any collision warnings. The vehicle will not brake automatically in critical situations.</p> <p>There is a risk of an accident if you do not adapt your driving style.</p> <ul style="list-style-type: none"> ► Pay particular attention to the traffic situation. ► If necessary, use the service brake to brake the vehicle. ► Have the Active Brake Assist system checked at a qualified specialist workshop.
 <p>Emergency braking finished</p>	<p>Active Brake Assist has triggered an emergency braking manoeuvre (full brake application) and the emergency braking manoeuvre has been completed.</p> <ul style="list-style-type: none"> ► Remove the vehicle as quickly as possible from the danger zone, paying attention to road and traffic conditions as you do so. ► Switch off the engine. ► Apply the parking brake. ► Make sure that the vehicle is in proper operating order and that the load is secured properly.
 <p>Sideguard Assist inoperative</p>	<p>Supplementary text: Stop vehicle and clean sensor</p> <p>The sensor is dirty. Sideguard Assist is unavailable.</p> <p> WARNING</p> <p>If Sideguard Assist is unavailable, you will not receive any warnings from Sideguard Assist.</p> <p>There is a risk of an accident.</p> <ul style="list-style-type: none"> ► Stop the vehicle, paying attention to road and traffic conditions, and clean the sensor.



Electrical system and key

Display messages	Possible causes/consequences and ► Solutions
 <p>Consumer shutoff active</p>	<p>The engine is switched off and the battery charge level is low. The following electrical consumers are automatically deactivated:</p> <ul style="list-style-type: none"> • audio equipment • 24 V power sockets • 12 V socket • cigarette lighter • seat heating • loading tailgate • switch 1 for non-MB body (e.g. load compartment light) <p>If the vehicle is also equipped with a 24 V power socket, the first consumer is not deactivated. Non-MB body switch.</p> <ul style="list-style-type: none"> • stowage compartment lamp above the windscreen • ambient lighting <p>i The audio equipment can be switched on manually after automatic shutoff.</p> <p>► If necessary, start the engine. When you start the engine, the electrical consumers are available again.</p>
 <p>Please insert key again</p>	<p>If you remove the key from the key slot while the vehicle is in motion, the event window appears in the display.</p> <p>i In an emergency situation you can switch off the engine while the vehicle is in motion by pressing and holding the Start/Stop button.</p> <p>► Insert the key back into the slot of the ignition lock.</p>
 <p>Press and hold EMERGENCY OFF button for 3 s</p>	<p>If you have briefly pressed the Start/Stop button while driving, the event window appears in the display. In an emergency situation you can switch off the engine while the vehicle is in motion by pressing and holding the Start/Stop button.</p> <p>⚠ WARNING</p> <p>Driving characteristics change significantly when the engine is not running. There is a risk of an accident.</p> <p>► If you want to switch off the engine, press the Stop/Start button to the stop for approximately 3 seconds. The engine is switched off.</p>







Tyres

Display messages	Possible causes/consequences and ► Solutions
 <p>Tyre pressure in spare wheel too low</p>	<p>Additional text : Check and correct tyre pressure</p> <p>In addition to the event window, the  indicator lamp lights up in grey in the status area of the on-board computer. The tyre pressure of the spare wheel is too low.</p> <p>► Check the tyre pressure and, if necessary, correct it.</p>
 <p>Spare wheel tyre pressure sensor battery low</p>	<p>Additional text : Replace tyre pressure sensor</p> <p>In addition to the event window, the  indicator lamp lights up grey in the status area of the on-board computer. The battery of the tyre pressure sensor in the spare wheel is discharged.</p> <p>► Have the tyre pressure sensor replaced at a qualified specialist workshop.</p>
 <p>Tyre pressure monitor in spare wheel faulty</p>	<p>Supplementary text : Spare wheel tyre pressure monitor failure</p> <p>In addition to the event window, the  indicator lamp lights up grey in the status area of the on-board computer. The tyre pressure monitor on the spare tyre has malfunctioned. No signal is received by the tyre pressure sensor, e.g. due to a source of radio interference.</p> <p>► Drive on.</p> <p>As soon as the cause is rectified, the tyre pressure monitor in the spare wheel is reactivated and the tyre pressure value is displayed again.</p> <p>► If the tyre pressure monitor in the spare wheel is not automatically activated after a long journey, have the tyre pressure monitor checked at a qualified specialist workshop.</p>

Semitrailers

Display messages	Possible causes/consequences and ► Solutions
 <p>Coupling level reached</p>	<p>The  indicator lamp lights up red in the status area of the on-board computer as well as in the event window. The semitrailer has been detected while reversing. The semitrailer coupling is unlocked.</p> <p>► Continue the coupling procedure by reversing slowly.</p>

Service products and maintenance

Display messages	Possible causes/consequences and ► Solutions
	<p>The washer fluid level in the washer fluid reservoir for the windscreen washer/headlamp cleaning system has fallen to approximately 1 litre.</p> <p>► Refill the washer fluid reservoir (▷ page 357).</p>
 Air filter 12.08.20143,000 km (Example)	<p>A service is due soon.</p> <p>► Schedule a service appointment at a qualified specialist workshop.</p>
 Air filter Maintenance due (example)	<p>In addition to the event window, the  indicator lamp lights up in grey in the status area of the on-board computer.</p> <p>A service is due.</p> <p>► Have maintenance work carried out at a qualified specialist workshop.</p>
 Fully refuel the main tank first	<p>Supplementary text : The main tank is on the left-hand side of the vehicle or The main tank is the front tank on the left-hand side of the vehicle.</p> <p>The main tank has run dry. The supplementary text provides information about the location of the main tank.</p> <p>In vehicles with an additional fuel tank, you must observe the filling order. The fuel gauge otherwise does not correctly show the current fuel level, or the on-board computer the correct range.</p> <p>► First, completely fill the main tank on the left-hand side of the vehicle (▷ page 317).</p> <p>► Then fill up the additional fuel tank.</p>

Engine and cooling

Display messages	Possible causes/consequences and ► Solutions
 Example: Radiator shutters inoperative	<p>The upper or lower air regulation system is malfunctioning, e.g. due to objects blocking the engine radiator.</p> <p>► Stop the vehicle, paying attention to road and traffic conditions, and switch off the engine.</p> <p>► Check the upper and lower air regulation system for objects and dirt and remove the objects or dirt, as necessary.</p> <p>If no objects or dirt can be found or the event window is shown again:</p> <p>► Manually open the radiator shutters and lock them (▷ page 379).</p> <p>► Have the air regulation system checked at a qualified specialist workshop.</p>



Yellow event window

Notes

Important safety notes







If you ignore warning and indicator lamps and the event window, you will not be able to recognise failures and malfunctions in components or systems. Driving/braking characteristics may be affected and the operating and road safety of your vehicle may be limited. Have the affected system checked and repaired at a qualified specialist workshop. Always observe the warning lamps and event window and follow the corresponding measures.

Yellow event window

With a malfunction/notification of medium priority, the on-board computer displays a yellow event window. The on-board computer displays a yellow event window, e.g. if you have not performed the service work due. The on-board computer also displays a yellow event window for special operating conditions, e.g. if the diesel particle filter is saturated or if the clutch is under heavy load. If further information about the malfunction/notification is available, the event window displays the  symbol. You can display the information using the  button on the multifunction steering wheel. Observe the information and instructions in the event window.







BlueTec[®] exhaust gas aftertreatment

BlueTec[®] 4 and BlueTec[®] 5











Display messages	Possible causes/consequences and ► Solutions
 AdBlue reserve	Supplementary text  : Please top up AdBlue. The AdBlue [®] level has dropped to approximately 10%. ► Top up the AdBlue [®] tank immediately (▷ page 318). Otherwise, engine output may be reduced.
 AdBlue empty	Supplementary text  : Please top up AdBlue. The AdBlue [®] level has dropped to approximately 0%. Engine output will be reduced the next time that the engine is started. ► Adapt your driving style accordingly. ► Top up the AdBlue [®] tank immediately (▷ page 318).
 Engine power reduced	Supplementary text  : Please top up AdBlue. The AdBlue [®] level has dropped to approximately 0%. The engine power output is reduced. ► Adapt your driving style accordingly. ► Top up the AdBlue [®] tank immediately (▷ page 318).

BlueTec®6



Display messages	Possible causes/consequences and ► Solutions
 <p>AdBlue reserve</p>	<p>Supplementary text : Please top up AdBlue. The AdBlue® level has dropped to approximately 10%.</p> <ul style="list-style-type: none"> ► Top up the AdBlue® tank immediately (▷ page 318). Otherwise, engine output may be reduced and, also, speed may be limited to approximately 20 km/h.
 <p>AdBlue reserve</p>	<p>Supplementary text : Please top up with AdBlue. Risk of reduction in engine power</p> <p>Additionally, the on-board computer displays the  indicator lamp in the status area. The AdBlue® level has dropped to approximately 7.5%.</p> <ul style="list-style-type: none"> ► Top up the AdBlue® tank immediately (▷ page 318). Otherwise, engine output may be reduced and, also, speed may be limited to approximately 20 km/h.
 <p>AdBlue very low</p>	<p>Supplementary text : Please top up with AdBlue. Reduction in engine power after stopping</p> <p>Additionally, the on-board computer displays the  indicator lamp in the status area. The AdBlue® level has dropped to approximately 2.5%.</p> <ul style="list-style-type: none"> ► Top up the AdBlue® tank immediately (▷ page 318). Otherwise, engine output will be reduced the next time the vehicle comes to a standstill and the speed may be limited to approximately 20 km/h.
 <p>AdBlue empty</p>	<p>Supplementary text : Please top up with AdBlue Risk of limit speed</p> <p>Additionally, the on-board computer displays the  indicator lamp in the status area. The AdBlue® level has dropped to approximately 0%.</p> <p>The engine power output is reduced.</p> <ul style="list-style-type: none"> ► Adapt your driving style accordingly. ► Top up the AdBlue® tank immediately (▷ page 318). Otherwise, the vehicle speed may be limited to approximately 20 km/h.

Display messages	Possible causes/consequences and ► Solutions
 Engine power reduced	Supplementary text  : Please top up with AdBlue Risk of limit speed Additionally, the on-board computer displays the  indicator lamp in the status area. The AdBlue® level has dropped to approximately 2.5%. The engine power output is reduced. <ul style="list-style-type: none"> ► Adapt your driving style accordingly. ► Top up the AdBlue® tank immediately (▷ page 318). Otherwise, speed may be limited to approximately 20 km/h.
 Limit speed	Supplementary text  : Please top up AdBlue Additionally, the on-board computer displays the  indicator lamp in the status area. The AdBlue® level has dropped to approximately 0%. Vehicle speed is limited to approximately 20 km/h. <ul style="list-style-type: none"> ► Adapt your driving style accordingly. ► Top up the AdBlue® tank immediately (▷ page 318).







Diesel particle filter





Display messages	Possible causes/consequences and ► Solutions
 <p>Diesel part. filter: fluid level increased</p>	<p>Supplementary text : Please start regeneration Please observe Operating Instructions</p> <p>The  indicator lamp also lights up yellow in the instrument cluster. The diesel particle filter is in need of regeneration.</p> <p>Depending on your operation of the vehicle, within the next 4 hours:</p> <ul style="list-style-type: none"> ► Deactivate the regeneration block (▷ page 312) and drive on a motorway or for a longer distance until the  indicator lamp goes out. <p>or</p> <ul style="list-style-type: none"> ► Start manual regeneration (▷ page 312).
 <p>Diesel particle filter full</p>	<p>Supplementary text : Start regeneration immediately Please observe the Operating Instructions</p> <p>The  indicator lamp also lights up yellow in the instrument cluster. The diesel particle filter is in need of regeneration.</p> <p>Depending on how the vehicle is being driven, within the next 30 minutes:</p> <ul style="list-style-type: none"> ► Deactivate the regeneration block (▷ page 312) and drive on a motorway or for a longer distance until the  indicator lamp goes out. <p>or</p> <ul style="list-style-type: none"> ► Immediately start manual regeneration (▷ page 312).
 <p>Diesel particle filter full</p>	<p>Supplementary text : Start regeneration immediately Please observe the Operating Instructions</p> <p>The  indicator lamp also flashes yellow in the instrument cluster. The diesel particle filter is in immediate need of regeneration and this is the last possibility for it to be started manually.</p> <ul style="list-style-type: none"> ► Immediately start manual regeneration (▷ page 312). Otherwise, the diesel particle filter can only be cleaned or exchanged at a qualified specialist workshop.

Service products and maintenance













Display messages	Possible causes/consequences and ► Solutions
	<p>The fuel has dropped to the reserve level.</p> <ul style="list-style-type: none"> ► Refill the fuel tank (▷ page 315).
 <p>Engine Maintenance due immediately (example)</p>	<p>The  indicator lamp lights up yellow in the status area of the on-board computer as well as in the event window.</p> <p>A service due date has been significantly exceeded. This could result in damage to the vehicle and its assemblies. It could also result in increased wear.</p> <ul style="list-style-type: none"> ► Have maintenance work carried out immediately at a qualified specialist workshop.







Compressed-air system, engine and cooling system

Display messages	Possible causes/consequences and ► Solutions
 <p>Condensation in compressed-air reservoir</p>	<p>The compressed-air dryer is malfunctioning.</p> <ul style="list-style-type: none"> ► Have the compressed-air dryer checked at a qualified specialist workshop.
 <p>Transmission/clutch reserve pressure too low</p>	<p>The reservoir pressure in the transmission/clutch is too low.</p> <p>⚠ WARNING</p> <p>The gears can no longer be changed properly. There is a risk of an accident.</p> <ul style="list-style-type: none"> ► Stop the vehicle at once, paying attention to road traffic conditions. ► Apply the parking brake. ► Let the engine run until the event window goes out and the reservoir pressure has reached an adequate level. ► If the malfunction occurs regularly, have the compressed-air system checked at a qualified specialist workshop.
 <p>Drive control faulty</p>	<p>Supplementary text : Visit workshop</p> <p>The electronic drive control is malfunctioning.</p> <ul style="list-style-type: none"> ► Observe the instructions in the event window.
 <p>Engine faulty</p>	<p>One of the following systems is malfunctioning:</p> <ul style="list-style-type: none"> • engine • engine cooling • engine management • fuel injection system <ul style="list-style-type: none"> ► Have the systems checked at a qualified specialist workshop.
 <p>Engine cooling faulty</p>	<p>The poly-V-belt may be damaged or the tension of the poly-V-belt may not be sufficient.</p> <ul style="list-style-type: none"> ► Have the poly-V-belt checked at a qualified specialist workshop.
 <p>Coolant temperature too high</p>	<p>The coolant temperature is too high. Engine power output is automatically reduced.</p> <ul style="list-style-type: none"> ► Reduce the speed. ► Shift to a lower gear. <p>or</p> <ul style="list-style-type: none"> ► Stop the vehicle, paying attention to road and traffic conditions. ► Switch off the engine. ► Remove objects that could block the air supply to the radiator, e.g. paper which has blown onto the grille.







Display messages	Possible causes/consequences and ► Solutions
 <p>Engine protection: engine power reduced</p>	<p>The coolant temperature is too high. Engine power output is automatically reduced.</p> <ul style="list-style-type: none"> ► Reduce the speed. ► Shift to a lower gear. <p>or</p> <ul style="list-style-type: none"> ► Stop the vehicle, paying attention to road and traffic conditions. ► Switch off the engine. ► Remove objects that could block the air supply to the radiator, e.g. paper which has blown onto the grille.
 <p>Coolant pressure regulation faulty</p>	<p>The electrical connection or the hose fitting on the coolant expansion tank is loose. The turquoise cap on the coolant expansion tank is not tight.</p> <ul style="list-style-type: none"> ► Check the electrical connection and the hose fitting on the coolant expansion tank (► page 356). ► If you detect any leakage, have the engine cooling system checked at a qualified specialist workshop.
 <p>Coolant level too low</p>	<p>Supplementary text : Top up coolant</p> <p>The coolant level has dropped below the normal filling level. The yellow event window is shown when the engine is cold and the ignition lock is in the drive position.</p> <ul style="list-style-type: none"> ► Top up the coolant (► page 356). ► If the coolant level drops again, immediately have the cooling system checked at a qualified specialist workshop.





Transmission and clutch

Display messages	Possible causes/consequences and ► Solutions
 <p>Transmission faulty</p>	<p>Supplementary text : Visit workshop.</p> <p> WARNING</p> <p>The transmission gearshift system is malfunctioning. The journey can be continued, but with restrictions.</p> <ul style="list-style-type: none"> ► Have the transmission checked at a qualified specialist workshop.
 <p>Transmission faulty (only vehicles with auto- matic transmission)</p>	<p>Supplementary text : Visit workshop.</p> <p> WARNING</p> <p>The automatic transmission is malfunctioning. The journey can be continued, but with restrictions.</p> <p>Depending on the fault, a specialist workshop may be able to assist you in restricted continuation of your journey if you supply the fault code. You can view the fault codes either by using the Diagnosis (► page 149) menu window in the on-board computer or the touch-key gearshift of the automatic transmission.</p> <p>Displaying the fault codes via the touch-key gearshift:</p> <ul style="list-style-type: none"> ► Simultaneously press the  and  buttons on the touch-key gearshift twice. The touch-key gearshift display shows the 5-digit fault codes in sequence. ► To display the next fault code, press the MODE button. A maximum of 5 fault codes can be stored. ► To stop displaying fault codes, press the  and  buttons of the automatic transmission simultaneously. <p>or</p> <ul style="list-style-type: none"> ► Shift the automatic transmission to the neutral position.
 <p>Transmission: oil temperature too high</p>	<p>Supplementary text : Visit workshop.</p> <p>The permissible operating temperature of the transmission or retarder has been reached. The temperature of the transmission oil or coolant is too high. The reason for this may be that the oil level in the transmission is too high or too low. If excessive oil temperature persists in the transmission, the transmission may be damaged.</p> <ul style="list-style-type: none"> ► Switch off the retarder. ► Stop the vehicle as soon as possible, paying attention to traffic conditions. ► Apply the parking brake and shift the automatic transmission to neutral. ► Run the engine for 2 to 3 minutes at a speed between 1,200 and 1,500 rpm and then switch off the engine. ► If the temperature of the fluid does not drop, check the automatic transmission fluid level (► page 360). ► If the event message does not go out, contact a qualified specialist workshop and have the malfunction rectified.





Display messages	Possible causes/consequences and ► Solutions
 <p>Clutch faulty</p>	<p>Supplementary text : Visit workshop</p> <p> WARNING</p> <p>The clutch is malfunctioning. The journey can be continued, but with restrictions.</p> <ul style="list-style-type: none"> ► Have the clutch checked at a qualified specialist workshop.
 <p>Clutch under heavy strain</p>	<p>The permissible operating temperature of the clutch has been reached. There is a risk of clutch damage if placed under further load.</p> <ul style="list-style-type: none"> ► Engage a lower gear when manoeuvring or pulling away. ► Complete the pulling away or manoeuvring process as quickly as possible. Otherwise, the clutch will be overloaded.
 <p>Clutch plate oil temperature 180 °C</p>	<p>The oil temperature in the hydraulic clutch is too high.</p> <ul style="list-style-type: none"> ► Shift to a lower gear. The engine speed increases and the dry clutch is engaged.
 <p>Retarder: oil temperature too high</p>	<p>The oil temperature in the retarder is too high.</p> <ul style="list-style-type: none"> ► Shift to a lower gear. The engine speed and the engine braking effect increase.
 <p>Transmission in off-road reduction ratio</p>	<p>You are driving faster than approximately 50 km/h with the off-road gear engaged. The temperature in the retarder is too high.</p> <ul style="list-style-type: none"> ► If the off-road gear is engaged, drive with a lower engine speed or engage the road gear.













Trailers/semitrailers









Display messages	Possible causes/consequences and ► Solutions
 <p>Wheel brake overload</p>	<p>Supplementary text : Adapt your driving style</p> <p>The temperature of one of the drum brakes/disc brakes on the tractor vehicle is too high. The drum brake/disc brake may overheat.</p> <p> WARNING</p> <p>The vehicle's driving and braking characteristics may change. Also observe the information in the separate operating instructions provided by the trailer/semitrailer manufacturer.</p> <p>There is a risk of an accident.</p> <ul style="list-style-type: none"> ► Drive on carefully. ► Shift to a lower gear. ► Brake the vehicle with the continuous brake. ► Only depress the brake pedal if the continuous brake cannot decelerate the vehicle sufficiently. ► Have the brake system checked at a qualified specialist workshop.
 <p>Check tyre pressure</p>	<p>On at least one of the trailer/semitrailer tyres, the tyre pressure is too low.</p> <p> WARNING</p> <p>Driving/braking characteristics may change. Also observe the information in the separate operating instructions provided by the trailer/semitrailer manufacturer.</p> <p>There is a risk of an accident.</p> <ul style="list-style-type: none"> ► Stop the vehicle without steering or braking suddenly. Pay attention to the traffic conditions. ► Check the tyre pressure and, if necessary, correct it.
 <p>Starting-off aid active</p>	<p>The starting-off aid on the trailer/semitrailer is activated.</p> <ul style="list-style-type: none"> ► Observe the separate operating instructions issued by the trailer/semitrailer manufacturer.
 <p>Additional axle raised</p>	<p>The leading/trailing axle on the trailer/semitrailer is raised.</p> <ul style="list-style-type: none"> ► Observe the separate operating instructions issued by the trailer/semitrailer manufacturer.



Display messages	Possible causes/consequences and ► Solutions
 <p>Note trailer height</p>	<p>The  indicator lamp lights up yellow in the instrument cluster as well as in the event window. The level control of the trailer/semitrailer is not at driving level.</p> <p>▲ WARNING</p> <p>The vehicle's driving and braking characteristics may change when driving.</p> <p>There is a risk of an accident if you do not adapt your driving style.</p> <p>Be aware of the headroom clearance of underpasses. Also observe the information in the separate operating instructions provided by the trailer/semitrailer manufacturer.</p> <p>► Set level control for the trailer/semitrailer to driving level; see the separate operating instructions provided by the trailer/semitrailer manufacturer.</p>
  <p>Example: Turn signal faulty</p>	<p>The turn signal on the trailer/semitrailer is faulty.</p> <p>► Replace the corresponding bulb; see the separate operating instructions issued by the trailer/semitrailer manufacturer.</p>





Braking and driving systems









Display messages	Possible causes/consequences and ► Solutions
 <p>ESP not available</p>	<p>Supplementary text : Visit workshop</p> <p>In addition, the  warning lamp lights up in the instrument cluster. Stability Control Assist is malfunctioning.</p> <p>▲ WARNING</p> <p>Driving/braking characteristics may change.</p> <p>There is a risk of an accident if you do not adapt your driving style.</p> <p>► Drive with even greater care.</p> <p>► Have Stability Control Assist checked at a qualified specialist workshop.</p>
 <p>ESP deactivated Set normal level</p>	<p>In addition, the  warning lamp lights up in the instrument cluster. If the chassis is not at driving level while driving, Stability Control Assist is deactivated.</p> <p>▲ WARNING</p> <p>Driving/braking characteristics may change.</p> <p>There is a risk of an accident if you do not adapt your driving style.</p> <p>► Set the driving level (► page 298).</p>

Display messages	Possible causes/consequences and ► Solutions
  Braking effect limited	Supplementary text  : Adapt your driving style The temperature of one of the disc brakes on the tractor vehicle is too high.  WARNING The disc brake may overheat. Driving/braking characteristics may change. There is a risk of an accident. ► Drive with even greater care. ► Shift to a lower gear. ► Brake the vehicle with the continuous brake. ► Only depress the brake pedal if the continuous brake cannot decelerate the vehicle sufficiently.
 Driving and braking characteristics changed	Supplementary text  : Visit workshop In addition, the  warning lamp lights up yellow in the instrument cluster. The vehicle's brake system is malfunctioning.  WARNING Driving and braking characteristics may change. There is a risk of an accident. ► Drive with even greater care. Adapt your driving style to suit the changed driving and braking characteristics. ► Have the brake system checked at a qualified specialist workshop.
 Set driving level.	The chassis is not at driving level. The distance control assistant and Active Brake Assist are inoperative. ► Set the driving level (► page 298).
 Distance sensor dirty	Supplementary text  : Stop vehicle and clean sensor. Active Brake Assist and distance control faulty The distance sensor is dirty. The distance control assistant and Active Brake Assist are inoperative.  WARNING If the distance control assistant and Active Brake Assist are inoperative, you will not receive any collision warnings. The vehicle will not brake automatically in critical situations. There is a risk of an accident. ► Clean the distance sensor cover in the front bumper using water (► page 352). Do not use any dry, rough or hard cloths and do not scrub or scratch.











Display messages	Possible causes/consequences and ► Solutions
 <p>Active Brake Assist not available</p>	<p>Example: supplementary text : Please have rectified at next maintenance</p> <p>Active Brake Assist is not available.</p> <p>▲ WARNING</p> <p>If Active Brake Assist is not available, you will not receive any collision warnings. In critical situations, the vehicle will not brake automatically.</p> <p>There is a risk of an accident if you do not adapt your driving style.</p> <ul style="list-style-type: none"> ► If necessary, use the service brake to brake the vehicle. ► Have the Active Brake Assist system checked at a qualified specialist workshop.
 <p>Camera's optical field of vision, dirty</p>	<p>Supplementary text : Stop vehicle and clean the windscreen Lane Keeping Assist and ATTENTION ASSIST unavailable</p> <p>▲ WARNING</p> <p>If Lane Keeping Assist and ATTENTION ASSIST are unavailable, you will not receive any warnings from Lane Keeping Assist or ATTENTION ASSIST.</p> <p>There is a risk of an accident.</p> <ul style="list-style-type: none"> ► Clean the area of the windscreen where the camera is located (► page 352).
 <p>Lane Keeping Assist not available</p>	<p>Supplementary text : Visit workshop Camera height calibration faulty Lane Keeping Assist and ATTENTION ASSIST not available</p> <p>▲ WARNING</p> <p>If Lane Keeping Assist and ATTENTION ASSIST are unavailable, you will not receive any warnings from Lane Keeping Assist or ATTENTION ASSIST.</p> <p>There is a risk of an accident.</p> <ul style="list-style-type: none"> ► Have Lane Keeping Assist and ATTENTION ASSIST checked at a qualified specialist workshop.
 <p>Lane Keeping Assist not available</p>	<p>Supplementary text : Visit workshop Lane Keeping Assist and ATTENTION ASSIST not available</p> <p>Lane Keeping Assist and ATTENTION ASSIST are malfunctioning.</p> <p>▲ WARNING</p> <p>If Lane Keeping Assist and ATTENTION ASSIST are unavailable, you will not receive any warnings from Lane Keeping Assist or ATTENTION ASSIST.</p> <p>There is a risk of an accident.</p> <ul style="list-style-type: none"> ► Have Lane Keeping Assist and ATTENTION ASSIST checked at a qualified specialist workshop.









Display messages	Possible causes/consequences and ► Solutions
 <p>Lane Keeping Assist faulty</p>	<p>Supplementary text : Visit workshop Lane Keeping Assist and ATTENTION ASSIST not available</p> <p>Lane Keeping Assist and ATTENTION ASSIST are malfunctioning.</p> <p> WARNING</p> <p>If Lane Keeping Assist and ATTENTION ASSIST are unavailable, you will not receive any warnings from Lane Keeping Assist or ATTENTION ASSIST.</p> <p>There is a risk of an accident.</p> <p>► Have Lane Keeping Assist and ATTENTION ASSIST checked at a qualified specialist workshop.</p>
 <p>Lane Keeping Assist faulty</p>	<p>Supplementary text : Visit workshop left speaker Lane Keeping Assist faulty or Visit workshop, right speaker Lane Keeping Assist faulty</p> <p> WARNING</p> <p>The left or right loudspeaker is malfunctioning. You will not receive any warnings from Lane Keeping Assist on the left or right sides.</p> <p>There is a risk of an accident.</p> <p>► Have Lane Keeping Assist checked at a qualified specialist workshop.</p>
 <p>Sideguard Assist faulty</p>	<p>Sideguard Assist is malfunctioning.</p> <p> WARNING</p> <p>If the Sideguard Assist is malfunctioning, you may not necessarily receive a warning from Sideguard Assist.</p> <p>There is a risk of an accident.</p> <p>► Have Sideguard Assist checked at a qualified specialist workshop.</p>
 <p>ATTENTION ASSIST: take a break?</p>	<p>ATTENTION ASSIST has detected tiredness or increasing lapses in concentration.</p> <p>A warning tone also sounds.</p> <p>► Confirm the warning by pressing the  button.</p> <p>► If necessary, take a break.</p> <p>During long journeys, take regular breaks in good time.</p>

Display messages	Possible causes/consequences and ► Solutions
 <p>Steering characteristics changed</p>	<p>Supplementary text : Do not steer when the vehicle is at a standstill. Steer carefully when the vehicle is moving at walking pace or Please have rectified at next maintenance</p> <p>The power-steering function has detected a malfunction. The feel of the steering may change.</p> <p>If you steer abruptly when manoeuvring, the steering may go into emergency mode.</p> <ul style="list-style-type: none"> ► Stop the vehicle, paying attention to road and traffic conditions. ► Switch off the ignition. ► Start the engine. ► If the fault is displayed again or continues to be displayed: have the vehicle checked at a qualified specialist workshop.
 <p>Do not turn the steering wheel to the stop</p>	<p>Supplementary text : Active steering wheel return inoperative or Please have rectified at next maintenance</p> <p>A fault has occurred in the steering control unit. The vehicle's driving characteristics (feel) may change. The steering wheel will not return to the straight-ahead position.</p> <p>Do not turn the steering wheel to the stop. Otherwise, the steering may overheat.</p> <ul style="list-style-type: none"> ► Stop the vehicle, paying attention to road and traffic conditions. ► Switch off the ignition. ► Start the engine. ► If the fault is displayed again or continues to be displayed: have the steering checked at a qualified specialist workshop.
 <p>Leading/trailing axle centred</p>	<p>The steerable additional axle is malfunctioning and is centred automatically. It is deactivated and no longer steers actively.</p> <ul style="list-style-type: none"> ► Drive on carefully and stop at the next available opportunity. Adjust your driving style to the changed handling and steering characteristics. ► Stop the vehicle and switch off the engine. ► Start the engine after approximately 10 seconds. The event window goes out. The steerable additional axle is reactivated. ► If the event window does not disappear: have the steerable additional axle checked at a qualified specialist workshop.













Display messages	Possible causes/consequences and ► Solutions
 <p>Brakes, axle 1 Maintenance due immediately (example)</p>	<p>The  indicator lamp lights up yellow supplemented by  in the status area of the on-board computer.</p> <p>The service work due has not been performed.</p> <p>The wear limit of the brake pads/linings and/or brake discs has been exceeded.</p> <p> WARNING</p> <p>The vehicle's driving and braking characteristics may change. There is a risk of an accident.</p> <p>► Have the brake pads/linings replaced immediately at a qualified specialist workshop.</p>
 <p>Brake pads/linings completely worn</p>	<p>Supplementary text : Visit workshop</p> <p>The wiring for the trailer/semitrailer is not connected or the service work due has not been performed on the trailer/semitrailer. The wear limit of the brake pads/linings and/or brake discs of the trailer/semitrailer has been exceeded.</p> <p> WARNING</p> <p>The vehicle's driving and braking characteristics may change. Also observe the information in the separate operating instructions provided by the trailer/semitrailer manufacturer.</p> <p>There is a risk of an accident.</p> <p>► Have the trailer/semitrailer wiring checked immediately at a qualified specialist workshop.</p> <p>or</p> <p>► Have the brake pads/linings on the trailer/semitrailer replaced immediately at a qualified specialist workshop.</p>
 <p>Deactivate shunting level</p>	<p>You are driving faster than approximately 20 km/h at shunting level. If you drive faster than approximately 40 km/h a warning tone also sounds.</p> <p> WARNING</p> <p>The vehicle's driving and braking characteristics may change. There is a risk of an accident if you do not adapt your driving style.</p> <p>► Deactivate shunting level (► page 299).</p> <p>or</p> <p>► Reduce the speed.</p>







Lighting system, electrical system and key

Display messages	Possible causes/consequences and ► Solutions
 Battery charge status not available	Supplementary text  : Please have rectified at next maintenance The measured values for the battery charge level are unavailable. You will not be warned when the battery charge level is critical. ► If electrical consumers are switched on when the engine is not running, monitor electrical consumption.
 Battery charge level low	Supplementary text  : Deactivate power consumers In addition, a brief warning tone also sounds. The battery charge level is low. ► Switch off electrical consumers that are not required, e.g. audio equipment, coolbox and climate control.
 Battery charge level too low Start engine	Supplementary text  : Please start engine and/or charge battery In addition, 3 warning tones sound. The engine is switched off and the battery charge level is too low. ► Start the engine. or ► Charge the batteries (► page 367). ► Switch off electrical consumers that are not required, e.g. audio equipment, coolbox and climate control.
 Generator is not charging battery	Supplementary text  : Visit workshop The  indicator lamp lights up yellow in the status area of the on-board computer as well as in the event window. The alternator is faulty or the poly-V-belt has torn.  WARNING The vehicle's driving and braking characteristics may change. There is a risk of an accident if you do not adapt your driving style. ► Have the alternator/poly-V-belt checked at a qualified specialist workshop immediately.
 Instrument cluster display and controls faulty	The CAN connection to the instrument cluster is interrupted. The display of the on-board computer can no longer show important information about the operating and road safety of the vehicle. ► Drive with even greater care. ► Have the instrument cluster checked at a qualified specialist workshop.

Display messages	Possible causes/consequences and ► Solutions
	<p>The entire exterior lighting of the vehicle is electronically monitored. When the event window is shown, a bulb has failed. The event window contains information about fault location and fault assistance, e.g. Replace light bulb. Left dipped beam faulty or Visit workshop. Left dipped beam faulty.</p> <p>If the event window displays "Replace bulbs":</p> <ul style="list-style-type: none"> ► Replace the corresponding bulb (► page 91). If you do not switch off the lighting system before replacing a bulb, it will be necessary to reset the event window afterwards. To do this, switch on the corresponding light or, if necessary, turn the ignition off and on again. <p>or</p> <ul style="list-style-type: none"> ► For LED bulbs and xenon bulbs, consult a qualified specialist workshop. <p>If the event window displays "Visit workshop":</p> <ul style="list-style-type: none"> ► Consult a qualified specialist workshop.
 <p>Incorrect key</p>	<p>You have inserted the wrong key into the key slot of the ignition lock.</p> <ul style="list-style-type: none"> ► Use the correct key.
 <p>Please replace key</p>	<p>Supplementary text : Please visit a workshop and have the key replaced</p> <p>The key must be replaced.</p> <ul style="list-style-type: none"> ► Consult a qualified specialist workshop.
 <p>Please replace ignition key battery</p>	<p>The key batteries are discharged.</p> <ul style="list-style-type: none"> ► Replace the batteries (► page 65).
 <p>Key invalid</p>	<p>Supplementary text : Please consult service centre and have the key replaced</p> <p>The key is malfunctioning or faulty. The key must be replaced.</p> <ul style="list-style-type: none"> ► Consult a qualified specialist workshop.
 <p>Ignition key not correctly inserted</p>	<p>Supplementary text : Please consult service centre and have the key replaced</p> <p>The key is not inserted completely into the key slot of the ignition lock.</p> <ul style="list-style-type: none"> ► Insert the key completely into the slot of the ignition lock. <p>or</p> <ul style="list-style-type: none"> ► If the event window is shown regularly: consult a qualified specialist workshop.

Tyres

Display messages	Possible causes/consequences and ► Solutions
 <p>Tyre pressure monitor inoperative</p>	<p>The  indicator lamp lights up yellow in the status area of the on-board computer as well as in the event window. The tyre pressure monitor is faulty.</p> <p>► Visit a qualified specialist workshop.</p>
 <p>Tyre pressure monitor faulty</p>	<p>Supplementary text : Failure, tyre pressure monitor for one/multiple tyre(s)</p> <p>The  indicator lamp lights up yellow in the status area of the on-board computer as well as in the event window. The tyre pressure monitor on one or more tyres has failed. No signal is received by the tyre pressure sensors, e.g. due to a source of radio interference.</p> <p>► Drive on.</p> <p>As soon as the cause is rectified, the tyre pressure monitor is reactivated and the tyre pressure level is displayed again.</p> <p>► If the tyre pressure monitor is not automatically activated after a long journey, have the tyre pressure monitor checked in a qualified specialist workshop.</p>
 <p>Tyre pressure sensor faulty</p>	<p>The  indicator lamp lights up yellow in the status area of the on-board computer as well as in the event window. The tyre pressure sensor is malfunctioning on one of the tyres.</p> <p>► Have the tyre pressure sensor replaced at a qualified specialist workshop.</p>
 <p>Tyre pressure sensor battery low</p>	<p>Supplementary text : Replace tyre pressure sensor</p> <p>The  indicator lamp lights up yellow in the status area of the on-board computer as well as in the event window. The battery of a tyre pressure sensor is discharged.</p> <p>► Have the tyre pressure sensor replaced at a qualified specialist workshop.</p>
 <p>Tyre temperature too high</p>	<p>Supplementary text : Reduce speed drastically</p> <p>The  indicator lamp lights up yellow in the status area of the on-board computer as well as in the event window.</p> <p>⚠ WARNING</p> <ul style="list-style-type: none"> • The temperature in one or more tyres has risen significantly while driving • The brakes may have overheated • The tyre pressure is too low <p>Driving/braking characteristics may change. There is a risk of an accident.</p> <p>► Drive on slowly. The tyre temperature is lowered by the airflow.</p> <p>► If the tyre temperature has fallen, have the tyres and brakes checked and the cause of the problem rectified at a qualified specialist workshop.</p>

Display messages	Possible causes/consequences and ► Solutions
 Tyre pressure too low	Supplementary text  Check and correct tyre pressure The  indicator lamp lights up yellow in the status area of the on-board computer as well as in the event window. The tyre pressure in one or more of the tyres is too low. ► Check the tyre pressure and, if necessary, correct it.
 Tyre pressure too high	Supplementary text  Check and correct tyre pressure The  indicator lamp lights up yellow in the status area of the on-board computer as well as in the event window. The pressure in one or more tyres has risen significantly while driving. ► Stop the vehicle without steering or braking suddenly. Pay attention to the traffic conditions. ► Check the tyre pressure and, if necessary, correct it.



Red event window

Notes



Important safety notes

If you ignore warning and indicator lamps and the event window, you will not be able to recognise failures and malfunctions in components or systems. Driving/braking characteristics may be affected and the operating and road safety of your vehicle may be limited. Have the affected system checked and repaired at a qualified specialist workshop. Always observe the warning lamps and event window and follow the corresponding measures.









Red event window

For a malfunction of high priority, the on-board computer shows a red event window. The on-board computer shows a red event window, e.g. for low brake reservoir pressure. Immediately stop the vehicle while paying attention to the traffic conditions and contact a qualified specialist workshop. If further information about the malfunction is available, the event window displays the  symbol. You can display the information using the  button on the multifunction steering wheel. Observe the information and instructions in the event window.











BlueTec® exhaust gas aftertreatment

Display messages	Possible causes/consequences and ► Solutions
 Diesel particle filter full	Supplementary text  : Stop vehicle Consult service centre Regeneration is no longer possible The  indicator lamp also lights up red in the instrument cluster. The diesel particle filter has reached its soot saturation limit. Engine performance is reduced and manual regeneration is no longer possible. ► Clean the diesel particle filter as soon as possible or have it replaced.







Compressed-air system

Display messages	Possible causes/consequences and ► Solutions
<div data-bbox="117 215 201 263" style="border: 1px solid black; padding: 2px; display: inline-block;">  </div> Example: Brake supply pressure in circuit 1 too low	<p>In addition, the  warning lamp lights up red in the instrument cluster.</p> <p>The reservoir pressure in brake circuit 1  or 2  is too low. If the reservoir pressure in the spring actuator and the trailer's brake circuit is too low, the event window shows the  symbol.</p> <p>Possible causes:</p> <ul style="list-style-type: none"> • too much compressed air has been consumed • there is a leak in the compressed-air system <p> WARNING</p> <p>The operating and road safety of the vehicle are jeopardised. There is a risk of an accident.</p> <ul style="list-style-type: none"> ► Stop the vehicle at once, paying attention to road traffic conditions. ► Apply the parking brake. ► Start the engine. The compressed-air system is charged. <p>If the  warning lamp in the instrument cluster goes out:</p> <ul style="list-style-type: none"> ► Continue the journey. <p>If the  warning lamp in the instrument cluster does not go out:</p> <ul style="list-style-type: none"> ► Check the compressed-air brake system for leaks (► page 244). ► If the compressed-air brake system is not leaking, but the  warning lamp does not go out: have the compressed-air brake system checked at a qualified specialist workshop.











Engine and cooling







Display messages	Possible causes/consequences and ► Solutions
 <p>Engine oil pressure too low</p>	<p>Supplementary text : Stop vehicle. Switch off engine.</p> <p>The  indicator lamp lights up red in the status area of the on-board computer as well as in the event window. The engine oil pressure is too low.</p> <p>The operating safety of the engine is jeopardised.</p> <ul style="list-style-type: none"> ► Stop the vehicle at once, paying attention to road traffic conditions. ► Switch off the engine. ► Apply the parking brake. ► Check the engine oil level (▷ page 148) and top up oil (▷ page 360). ► Consult a qualified specialist workshop.
 <p>Coolant temperature too high</p>	<p>Supplementary text : Stop vehicle. Switch off engine.</p> <p>The  indicator lamp lights up red in the status area of the on-board computer as well as in the event window.</p> <ul style="list-style-type: none"> ► Stop the vehicle at once, paying attention to road traffic conditions. ► Switch off the engine. ► Apply the parking brake. ► Let the engine cooling system cool down.
 <p>Coolant level too low</p>	<p>Supplementary text : Top up coolant Coolant temperature not reliable</p> <p>The  indicator lamp lights up in the status area of the on-board computer as well as in the event window. As long as the  indicator lamp is on, the coolant temperature cannot be displayed.</p> <p>The coolant level has dropped to at least 3 litres below the normal filling level. The operating safety of the engine is jeopardised.</p> <ul style="list-style-type: none"> ► Stop the vehicle at once, paying attention to road traffic conditions. ► Switch off the engine. ► Apply the parking brake. ► Top up the coolant (▷ page 356). ► Have the engine cooling system checked for leaks at a qualified specialist workshop.

Transmission and clutch







Display messages	Possible causes/consequences and ► Solutions
 <p>Clutch faulty</p>	<p>Supplementary text : Stop vehicle. Contact service centre.</p> <p> WARNING</p> <p>The transmission no longer changes gear. The reservoir pressure in the transmission/clutch may be too low.</p> <ul style="list-style-type: none"> ► Stop the vehicle at once, paying attention to road traffic conditions. ► Apply the parking brake. ► If the Transmission/clutch reserve pressure too low event window is displayed: start the engine and let it run until there is adequate reservoir pressure in the transmission circuit/clutch circuit. The Transmission/clutch reserve pressure too low event window goes out. ► Switch off the engine. ► Start the engine again after approximately 10 seconds. ► If the Clutch faulty Stop vehicle. Contact service centre message is displayed again, activate backup mode. ► If backup mode cannot be activated, contact a qualified specialist workshop.
 <p>Transmission faulty</p>	<p>Supplementary text : Park vehicle safely. Gears can only be changed in backup drive mode.</p> <p> WARNING</p> <p>The transmission gearshift system is malfunctioning.</p> <ul style="list-style-type: none"> ► Activate backup drive mode. ► Move the vehicle to a safe position. ► Consult a qualified specialist workshop.









Semitrailers









Display messages	Possible causes/consequences and ► Solutions
 <p>Open semitrailer coupling</p>	<p>The  indicator lamp lights up red in the status area of the on-board computer as well as in the event window.</p> <p>If the on-board computer displays a warning and a warning tone sounds:</p> <ul style="list-style-type: none"> • the semitrailer coupling pin was detected during coupling/decoupling and • the sensor-monitored semitrailer is not engaged <p> WARNING</p> <p>The semi-trailer can become decoupled. There is a risk of an accident.</p> <p>► During decoupling: continue the process. ► During coupling: check the locking mechanism of the sensor-monitored semitrailer coupling.</p> <p>or</p> <p>► Couple the semitrailer again.</p>
 <p>Driving level below coupling level</p>	<p>The  indicator lamp lights up red in the status area of the on-board computer as well as in the event window. If the on-board computer displays a warning and a warning tone sounds, the semitrailer is no longer detected during reversing. The sensor-monitored semitrailer has not been coupled yet.</p> <p>► Correct the coupling level until the on-board computer displays the grey  Coupling level reached event window.</p>
 <p>Check semitrailer coupling</p>	<p>Additional text : Check semitrailer coupling: open if needed</p> <p>The  indicator lamp lights up red in the status area of the on-board computer as well as in the event window.</p> <p>If the on-board computer displays a warning and a warning tone sounds, the sensor-monitored semitrailer coupling is engaged and the semitrailer has not been detected.</p> <p> WARNING</p> <p>The semi-trailer can become decoupled. There is a risk of an accident.</p> <p>► Check the coupling on the sensor-monitored semitrailer.</p>







Display messages	Possible causes/consequences and ► Solutions
 <p data-bbox="115 220 322 268">Check semitrailer coupling</p>	<p data-bbox="372 172 1011 220">The  indicator lamp lights up red in the status area of the on-board computer as well as in the event window.</p> <p data-bbox="372 228 1033 300">If the on-board computer displays a warning and a warning tone sounds, the sensor-monitored semitrailer coupling is engaged and the semitrailer was not correctly detected.</p> <p data-bbox="384 316 535 347"> WARNING</p> <p data-bbox="372 355 759 411">The semi-trailer can become decoupled. There is a risk of an accident.</p> <ul style="list-style-type: none"> <li data-bbox="372 419 944 475">► Check the coupling on the sensor-monitored semitrailer. <li data-bbox="372 451 395 475">or <li data-bbox="372 483 675 507">► Couple the semitrailer again.
 <p data-bbox="115 587 344 635">Semitrailer coupling sensor faulty</p>	<p data-bbox="372 539 1011 587">The  indicator lamp lights up red in the status area of the on-board computer as well as in the event window.</p> <p data-bbox="372 595 1033 691">The sensor monitoring of the semitrailer coupling is malfunctioning. The condition of the sensor-monitored semitrailer coupling has not been correctly detected. Observe the additional text  regarding the malfunction/remedy in the red event window, e.g. Clean sensor.</p> <p data-bbox="384 707 535 738"> WARNING</p> <p data-bbox="372 746 759 802">The semi-trailer can become decoupled. There is a risk of an accident.</p> <ul style="list-style-type: none"> <li data-bbox="372 810 1022 834">► Clean the sensor; see the manufacturer's operating instructions. <li data-bbox="372 842 944 866">► Check the coupling on the sensor-monitored semitrailer.

Braking and driving systems













Display messages	Possible causes/consequences and ► Solutions
	<p> WARNING</p> <p>Active Brake Assist warns you of a risk of colliding with the vehicle in front.</p> <p>There is a risk of an accident.</p> <p>When an automatic collision warning is being given, you must brake the vehicle using the service brake if:</p> <ul style="list-style-type: none"> • the on-board computer displays the  warning in a red event window • an intermittent warning tone sounds <p>► Pay particular attention to the traffic situation.</p> <p>► Slow down the vehicle using the service brake.</p>
 <p>Engage parking brake</p>	<p>The distance control assistant has stopped the vehicle. You have not applied the parking brake and:</p> <ul style="list-style-type: none"> • left the driver's seat • opened the driver's door • switched off the engine <p> WARNING</p> <p>The distance control assistant function is no longer keeping the vehicle stationary. The parked vehicle could roll away. You could endanger yourself and others.</p> <p>There is a risk of an accident.</p> <p>► Apply the parking brake.</p>
 <p>Engage parking brake</p>	<p>The parking brake is not applied.</p> <p>The vehicle was parked with a gear applied and the parking brake released. After the engine has been switched off, the transmission automatically shifts to neutral.</p> <p> WARNING</p> <p>The parked vehicle could roll away. You could endanger yourself and others.</p> <p>There is a risk of an accident.</p> <p>► Apply the parking brake.</p>

Display messages	Possible causes/consequences and ► Solutions
 <p>Engage parking brake</p>	<p>Vehicles with a programmable special module: the parking brake is not applied.</p> <p>The parking brake has not been applied before engaging power take-off.</p> <p> WARNING</p> <p>The parked vehicle could roll away. You could endanger yourself and others.</p> <p>There is a risk of an accident.</p> <p>► Apply the parking brake before engaging power take-off.</p>
 <p>Increased brake force and pedal travel</p>	<p>Supplementary text : Stop vehicle. Contact service centre.</p> <p>In addition, the  warning lamp lights up red in the instrument cluster.</p> <p>Full braking power may not be available.</p> <p> WARNING</p> <p>Driving and braking characteristics are affected. The operating and road safety of the vehicle are jeopardised.</p> <p>There is a risk of an accident.</p> <p>► Carefully bring the vehicle to a standstill and park it safely.</p> <p>► Apply the parking brake.</p> <p>► Consult a qualified specialist workshop.</p>
 <p>Power steering: function not assured</p>	<p>Supplementary text : Stop vehicle or start engine</p> <p>In addition, the  warning lamp lights up red in the instrument cluster.</p> <p>The vehicle rolls, although the engine is not switched on.</p> <p>► Stop the vehicle.</p> <p>or</p> <p>► Start the engine.</p>

Display messages	Possible causes/consequences and ► Solutions
 <p>Power steering: function not assured</p>	<p>Supplementary text : Stop vehicle Check hydraulic steering during shunting Consult service centre</p> <p>In addition, the  warning lamp lights up red in the instrument cluster.</p> <p>Steering operates in emergency mode.</p> <p> WARNING</p> <p>The hydraulic power steering has failed. There is a risk of an accident.</p> <ul style="list-style-type: none"> ► Stop the vehicle immediately, paying attention to road and traffic conditions. ► Switch off the ignition. ► Start the engine. ► If the fault is displayed again or continues to be displayed: consult a qualified specialist workshop.
 <p>Power steering: function not assured</p>	<p>Supplementary text : Stop vehicle. Contact service centre.</p> <p>In addition, the  warning lamp lights up red in the instrument cluster.</p> <p>A fault has occurred in the electric power steering.</p> <p> WARNING</p> <p>Power steering function cannot be assured. There is a risk of an accident.</p> <ul style="list-style-type: none"> ► Stop the vehicle immediately, paying attention to road and traffic conditions. ► Switch off the ignition. ► Start the engine. ► If the fault is displayed again or continues to be displayed: consult a qualified specialist workshop.

Display messages	Possible causes/consequences and ► Solutions
 <p>Power-steering assistance overheated</p>	<p>Supplementary text : Stop vehicle. Switch off engine. In addition, the  warning lamp lights up red in the instrument cluster.</p> <p>The steering gear has overheated.</p> <ul style="list-style-type: none"> ► Stop the vehicle immediately, paying attention to road and traffic conditions. ► Switch off the ignition. ► Let the steering gear cool down. ► Start the engine. ► If the fault reappears: consult a qualified specialist workshop.
 <p>Steer. characteristics of add. axle changed</p>	<p>Supplementary text : Visit workshop</p> <p>The steerable additional axle is malfunctioning and only steers passively. Stability Control Assist may also have been deactivated as a result. If Stability Control Assist is deactivated, the yellow  event window displays ESP not available.</p> <p>In extreme driving conditions, e.g. when braking hard on a slippery or uneven road surface, the steerable additional axle may deactivate itself. It will then only steer passively. On vehicles with a height-adjustable trailing axle, it is no longer possible to lower the additional axle while the vehicle is moving.</p> <p> WARNING</p> <p>If Stability Control Assist is deactivated due to a faulty steerable additional axle, the vehicle's stability is decreased. There is a risk of an accident.</p> <ul style="list-style-type: none"> ► Drive on carefully and stop at the next available opportunity. Adjust your driving style to the changed handling and steering characteristics. ► Stop the vehicle and switch off the engine. ► Start the engine after approximately 10 seconds. The event window goes out. The steerable additional axle is reactivated. ► If the event window does not disappear: have the steerable additional axle checked at a qualified specialist workshop.

Tyres

Display messages	Possible causes/consequences and ► Solutions
 <p>Flat tyre</p>	<p>Supplementary text : Change tyre</p> <p>The  indicator lamp lights up red in the status area of the on-board computer as well as in the event window. The tyre pressure has suddenly dropped in one or more tyres. A warning tone also sounds.</p> <p> WARNING</p> <p>The driving and braking characteristics are affected. There is a risk of an accident.</p> <ul style="list-style-type: none"> ► Stop the vehicle without steering or braking suddenly. Pay attention to the traffic conditions. ► If necessary, change the tyre (▷ page 380). <p>Cement mixer vehicle with single tyres: the vehicle is designed in such a way that, in the case of a flat tyre on a rear axle, the vehicle can continue to travel a short distance at reduced speed. This allows you to find a safe place to stop the vehicle for the purposes of changing a wheel.</p> <ul style="list-style-type: none"> ► Check the scale of the damage to the wheel (tyre and rim). ► If a faulty tyre presents a danger to other road users: do not continue your journey. ► Replace the tyre immediately (▷ page 380). <p>or</p> <ul style="list-style-type: none"> ► If a faulty tyre does not present a danger to other road users: continue driving until you find a suitable place to pull over. ► Drive at a maximum of 40 km/h on straight stretches of road. ► On bends, drive at a maximum of 15 km/h.
 <p>Tyre pressure too low</p>	<p>Additional text : Check and correct tyre pressure</p> <p>The  indicator lamp lights up red in the status area of the on-board computer as well as in the event window. The tyre pressure in one of the tyres is too low.</p> <p> WARNING</p> <p>The driving and braking characteristics are affected. There is a risk of an accident.</p> <ul style="list-style-type: none"> ► Stop the vehicle without steering or braking suddenly. Pay attention to the traffic conditions. ► Check the tyre pressure and, if necessary, correct it.
 <p>Locked wheel</p>	<p>Additional text : Stop vehicle and release locked wheel</p> <p>The  indicator lamp lights up red in the status area of the on-board computer as well as in the event window. At least one wheel is blocked. A warning tone also sounds.</p> <p> WARNING</p> <p>The driving characteristics are affected. There is a risk of an accident.</p>

Display messages	Possible causes/consequences and ► Solutions
	<ul style="list-style-type: none"> ► Stop the vehicle. Pay attention to the traffic conditions. ► Check wheel position and release blockage if necessary.

Indicator lamps in the status area of the display

Important safety notes

If you ignore warning and indicator lamps, you will not be able to recognise failures and malfunctions in components or systems. Driving/braking characteristics may be affected and the operating and road safety of your vehicle may be limited. Have the affected system checked and repaired at a qualified specialist workshop. Always observe the warning and indicator lamps and follow the corresponding measures.

Overview



Example: warning and indicator lamps in the on-board computer

If there is a fault, warning or operating information, a warning lamp or indicator lamp lights up in status area ① of the on-board computer. The warning lamp/indicator lamp lights up in a different colour, depending on the priority of the fault, warning or the operating information. The warning lamp/indicator lamp may also light up in addition to an event window.

	Warning and indicator lamps
	Driver's airbag (► page 52)
	Seat belt warning (► page 52)
	An emissions-relevant malfunction in the BlueTec® exhaust gas after-treatment system or low AdBlue® supply (► page 131)
	Engine oil pressure too low; see the corresponding event window
	Engine oil level too low (► page 148)
	Coolant level too low (► page 178)
	Charge status of the battery, see corresponding event window
	Power supply malfunction (► page 173)
	Maintenance due date; see the corresponding event window
	Leading axle (► page 300)
	Trailing axle (► page 300)
	Starting-off aid (► page 300)
	Steerable additional axle centred (► page 301)
	Steering angle disparity in steerable additional axle (► page 301)
	Steerable additional axle malfunction (leading/trailing axle centred) or power steering malfunction (► page 167)
	Steerable additional axle malfunction or power steering malfunction (► page 182)
	Sensor-monitored semitrailer coupling (► page 322)
	Sensor-monitored semitrailer coupling (► page 322)



Warning and indicator lamps	
	Sensor-monitored semitrailer coupling malfunction (▷ page 180)
	Semitrailer coupling, refill grease reservoir (see separate Operating Instructions)
	Loading tailgate (see the separate Operating Instructions)
	Power take-off (▷ page 341)
	Continuous brake malfunction (▷ page 250)
	Tyre pressure monitor warning message, see corresponding event window
	Tyre pressure monitor (▷ page 144)
	Frequent-stop brake (▷ page 248)

Warning and indicator lamps	
	ABS equipment shown with or for tractor vehicle and/or trailer/semitrailer (▷ page 245)
	ABS trailer/semitrailer malfunction (▷ page 245)
	Trailer/semitrailer brake system malfunction; see the corresponding warning/indicator lamps in the following sections
	Brake pads/lining wear shown with for tractor vehicle (▷ page 167) or shown with for trailer/semitrailer (▷ page 167)
	Control intervention by Stability Control Assist in trailers/semitrailers (▷ page 267)

Yellow warning/indicator lamp

Problem	Possible causes/consequences and ► Solutions
The indicator lamp in the status area of the on-board computer lights up yellow.	<p> Risk of accident</p> <p>The trailer's/semitrailer's brake system is malfunctioning. Driving/braking characteristics may change. Also observe the information in the separate operating instructions provided by the trailer/semitrailer manufacturer.</p> <ul style="list-style-type: none"> ► Drive on carefully. ► Have the brake system checked at a qualified specialist workshop.

Red warning/indicator lamp

Problem	Possible causes/consequences and ► Solutions
The  indicator lamp in the status area of the on-board computer lights up red.	<p data-bbox="375 223 599 252"> Risk of accident</p> <p data-bbox="375 263 1024 391">The trailer's/semitrailer's brake system is malfunctioning or the trailer/semitrailer is automatically braked. Driving/braking characteristics may change. Also observe the information in the separate operating instructions provided by the trailer/semitrailer manufacturer.</p> <ul data-bbox="375 399 1024 510" style="list-style-type: none"><li data-bbox="375 399 1024 446">► Brake carefully and stop the vehicle, paying attention to road and traffic conditions.<li data-bbox="375 454 1024 478">► Apply the parking brake.<li data-bbox="375 486 1024 510">► Consult a qualified specialist workshop.

Useful information

These Operating Instructions describe all the models and standard and optional equipment of your vehicle that were available at the time of going to print. Country-specific differences are possible. Bear in mind that your vehicle may not be equipped with all the functions described. This also applies to safety-relevant systems and functions.

Read the information on qualified specialist workshops (▷ page 31).

Important safety notes

WARNING

If you operate information and communication equipment integrated in the vehicle when driving, you could be distracted from the traffic situation. This could also cause you to lose control of the vehicle. There is a risk of an accident.





Only operate this equipment when the traffic situation permits. If you cannot be sure of this, stop the vehicle paying attention to road and traffic conditions and operate the equipment with the vehicle stationary.

When using FleetBoard, observe the legal requirements of the country in which you are currently driving.

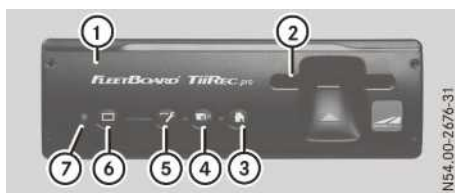
FleetBoard vehicle computer with integrated card reader

FleetBoard overview



- ① FleetBoard vehicle computer
- ② Card slot (driver card or FleetBoard Driver-Card)
- ③  Home-Call button
- ④  Event-Call button
- ⑤  Service-Call button
- ⑥  Reads out driver card and sends data
- ⑦  LED indicator lamp

FleetBoard is an innovative Internet-based telematics service designed to provide constant communication between vehicle and headquarters at any time and location.

Some requirements must be met before FleetBoard can be operated, e.g. a service contract. For more information, please contact FleetBoard Support, see contact details in the publication details. You can obtain information on FleetBoard from any Mercedes-Benz Service Centre.

FleetBoard vehicle management enables unlimited access to consumption figures and information about vehicle parts that are subject to wear.

FleetBoard functions

The FleetBoard vehicle computer allows you to carry out the following functions:

- Analyse and calculate the driving style
- Record journey and rest periods
- Determine the position of the vehicle
- Remote readout of the driver card and the mass storage device of the digital tachograph
- Send predefined messages from the vehicle (Home-Call, Service-Call, Event-Call)
- Send vehicle maintenance due dates to the maintenance schedule, e.g. remaining distance for engine and transmission oil
- Send vehicle fault memory for fast diagnosis and breakdown assistance (only if the disclosure of data has been agreed to in the service contract)
- Send data for the purpose of operational analysis of the vehicle, e.g. current use and operating conditions
- Analyse and evaluate vehicle data via the Internet

Inserting/removing the FleetBoard DriverCard



FleetBoard DriverCard

The FleetBoard DriverCard is used to identify the driver for driver-related evaluation.



Avoid touching the contact surface points of memory chip ① with your fingers. Otherwise, errors could occur when reading memory chip ①.

- ▶ Switch the ignition lock to the drive position.

Before beginning the journey/trip:

- ▶ **To insert:** insert FleetBoard DriverCard ② into the card slot of the FleetBoard vehicle computer until it engages. The lettering and memory chip ① on the FleetBoard DriverCard ② must be face up. If the FleetBoard DriverCard ② is inserted incorrectly, a warning tone sounds.

After the end of the journey/trip:



- ▶ **To remove:** remove FleetBoard DriverCard ② from the card slot.

Sending a message

With the FleetBoard vehicle computer, you can send three different messages to headquarters that have been predefined by headquarters.

- ▶ Switch the ignition lock to the drive position.

i When the green LED on the FleetBoard vehicle computer lights up permanently, the FleetBoard vehicle computer is operational.

- ▶ **To send a Home or Event-Call message:** press the  or  button on the FleetBoard vehicle computer.

A short warning tone sounds over the loudspeaker. The FleetBoard vehicle computer generates the data which is to be sent; this may take a few seconds.

- ▶ **To send a Service-Call message/to activate roadside assistance:** press the  button on the FleetBoard vehicle computer for approximately 2 seconds.

A short warning tone sounds over the loudspeaker and the orange LED indicator lamp flashes. The FleetBoard vehicle computer generates the data which is to be sent; this may take some time. Leave the ignition switched on while the data is being sent. A short warning tone sounds over the loudspeaker and the green LED indicator lamp flashes three times when the message has been successfully sent. The roadside assistance data is now available to Mercedes-Benz Service.

- ▶ Switch the ignition lock to position 0.
- ▶ Contact Mercedes-Benz Service (Customer Assistance Centre or national organisation).

If a longer warning tone sounds over the loud-speaker and the red LED indicator lamp flashes three times, the message has not been sent:

- ▶ Change the vehicle location.
- ▶ Send the message again.
- i** You will find further information on roadside assistance in the "Breakdown assistance" section (▶ page 369).

Reading out the driver card and sending the data

Data on the driver card



Driver card (example) (source: FMTA)

The data from the digital tachograph is stored on the driver card. You can use the FleetBoard vehicle computer to transmit this data to the FleetBoard Service Centre. Once the data has been transmitted, the central fleet office can download the data from the FleetBoard Service Centre via the Internet. The data must be made available to the authorities if requested.

The FleetBoard DriverCard is used to identify the driver for driver-related evaluation.

Avoid touching the contact surface points of memory chip with your fingers. Otherwise, errors could occur when reading the memory chip.

Reading out and sending data from the driver card

- ▶ Switch the ignition lock to the drive position.
- ▶ Insert the driver card into the card slot of the FleetBoard vehicle computer until it engages. The memory chip and the arrow on the driver card must be facing upwards. If the driver card is inserted incorrectly, a warning tone sounds.
- ▶ Press the  button on the FleetBoard vehicle computer for approximately 2 seconds. The LED indicator lamp on the FleetBoard vehicle computer flashes orange while the card is being read out. The card reading procedure can take up to approximately 1 minute. Once the card has been read out, a warning tone sounds and the LED indicator lamp lights up green again. The FleetBoard on-board computer automatically transmits the data it has read out to the FleetBoard Service Centre. Data is also transmitted when the key is not inserted in the ignition lock.
- ▶ Remove the driver card from the card slot.

Driver card read-out error	
Problem	Possible causes/consequences and ► Solutions
The LED indicator lamp lights up green and you hear a continuous warning tone until the driver card is removed.	<p>The FleetBoard vehicle computer has not detected a valid driver card. There could be several reasons for this:</p> <ul style="list-style-type: none"> • an invalid driver card has been inserted. • the driver card has been inserted incorrectly. • there is dirt on the driver card memory chip. <p>► Insert a valid driver card. Do not confuse the driver card with the FleetBoard DriverCard.</p> <p>► Clean the contact surface points of the memory chip carefully with a lint-free cloth.</p> <p>► Insert the driver card so that the arrow and contact surfaces of the memory chip face upwards.</p>
The LED indicator lamp flashes orange/red and you hear a continuous warning tone until the driver card is removed.	<p>The driver card has already been read out during the last 18 hours.</p> <p>► Wait until 18 hours have passed since the last reading procedure.</p>
The LED indicator lamp lights up red and you hear a continuous warning tone until the driver card is removed.	<p>The FleetBoard vehicle computer may be unable to transmit data as there is no connection to a mobile phone network.</p> <p>The temporary memory of the FleetBoard on-board computer is full.</p> <p>► Search for a location where you can connect to a mobile phone network and attempt to transmit the data again.</p> <p>► Call FleetBoard support, see the contact details in the publication details.</p>
The LED indicator lamp briefly lights up orange, then green.	<p>The "Send data" function is not enabled.</p> <p>► Call FleetBoard support, see the contact details in the publication details.</p>

FleetBoard vehicle computer with driver card

FleetBoard overview



- ①  Service Call button
- ② LED indicator lamp for the FleetBoard vehicle computer

FleetBoard is an innovative Internet-based telematics service designed to provide constant communication between vehicle and headquarters at any time and location.

Some requirements must be met before FleetBoard can be operated, e.g. a service contract. For more information, please contact FleetBoard Support; see contact details in the publication details. You can obtain information on FleetBoard from any Mercedes-Benz Service Centre.

FleetBoard vehicle management enables unlimited access to consumption figures and information about vehicle parts that are subject to wear.

FleetBoard functions

The FleetBoard vehicle computer allows you to carry out the following functions:

- Analyse and calculate the driving style
- Record journey and rest periods
- Determine the position of the vehicle
- Remote readout of the driver card and the mass storage device of the digital tachograph
- Send out a Service Call message from the vehicle
- Send vehicle maintenance due dates to the maintenance schedule, e.g. remaining distance for engine and transmission oil
- Send vehicle fault memory for fast diagnosis and breakdown assistance (only if the disclo-

sure of data has been agreed to in the service contract)

- Send data for the purpose of operational analysis of the vehicle, e.g. current use and operating conditions
- Analyse and evaluate vehicle data via the Internet

Sending a Service Call message

Using the FleetBoard vehicle computer, you can send a Service Call to the central unit.

- ▶ Switch the ignition lock to the drive position.

i If the green LED indicator lamp on the Service Call button goes out after lighting up at the start, the FleetBoard vehicle computer is ready for operation.

- ▶ **To send a Service Call message/to activate roadside assistance:** press the  button for approximately 2 seconds.

The LED indicator lamp flashes orange. The FleetBoard vehicle computer generates the data to be sent; this takes approximately 3 minutes. Leave the ignition switched on while the data is being sent. When the Service message has been successfully sent, the LED indicator lamp lights up green for approximately 4 seconds. The roadside assistance data is now available to Mercedes-Benz Service.

- ▶ Switch the ignition lock to position **0**.
- ▶ Contact Mercedes-Benz Service (Customer Assistance Centre or national organisation).

If the LED indicator lamp lights up red for approximately 4 seconds, the Service message was not sent. In this case:

- ▶ Change the vehicle location.
- ▶ Send the Service message again.
- i** You will find further information on roadside assistance in the "Breakdown assistance" section (▷ page 369).

Reading out the driver card and sending the data



N54.60-2009-31

Driver card (example) (source: FMTA)

The data from the digital tachograph is stored on the driver card. This data will be automatically

transmitted from the FleetBoard vehicle computer to the FleetBoard Service Centre. Once the data has been transmitted, the central fleet office can download the data from the FleetBoard Service Centre via the Internet. The data must be made available to the authorities if requested.

You can use the driver card for unambiguous identification of the driver.

Avoid touching the contact surface points of the memory chip with your fingers. Errors could otherwise occur when reading the memory chip.

LED indicator lamp display

The status of the FleetBoard vehicle computer can be read out on the LED indicator lamp below the Service Call button.

i If the FleetBoard vehicle computer is not activated, the LED indicator lamp is not lit up.

LED indicator lamp	Meaning
Flashes green	The FleetBoard vehicle computer starts up. The process can last several minutes.
Lights up green for approximately four seconds	The FleetBoard vehicle computer is ready for operation.
Flashes orange	The FleetBoard vehicle computer is carrying out a task at present (roadside assistance). If the task has been carried out successfully, the LED indicator lamp lights up green for approximately four seconds, then the LED indicator lamp goes out. ▶ Wait until the task has been carried out. ▶ Leave the ignition on; do not remove the key.
Flashes red for approximately four seconds	The last task was not correctly carried out. ▶ Turn the ignition off and then on again. ▶ If the problem persists: call FleetBoard support; see the contact details in the publication details.
Lights up continuously in red	The FleetBoard vehicle computer has detected a fault and is no longer functioning. ▶ Check the display in the on-board computer in the Diagnosis menu. ▶ Call FleetBoard support; see the contact details in the publication details.

Free and open source software

Information on licences for the free and open source software used in your device can be found on this website:
<http://www.fleetboard.com/license>

FleetBoard Truck Data Center 6 (DTCO)

Declaration of conformity

Simplified EU declaration of conformity

Hereby, Daimler AG declares that the radio equipment type CTPMID is in compliance with Directive 2014/53/EU. The full text of the EU declaration of conformity is available at the following internet address: <https://www.fleetboard.info/license>

Electromagnetic compatibility

The electromagnetic compatibility of the vehicle components has been checked and certified according to the currently valid version of Directive ECE-R 10.

Safety notes on electromagnetic fields

The FleetBoard vehicle computer receives and transmits radio waves when in operation. The FleetBoard vehicle computer was constructed and manufactured so that it does not exceed the limiting values recommended by the International Commission on Non-Ionizing Radiation Protection (ICNIRP) for exposure to radio waves.

Notes on radio malfunctions and interferences

Radio malfunctions can be caused by any device which emits electromagnetic signals. Due to the wide range of devices which transmit and receive radio waves, overlapping radio waves can also cause malfunctions. If you are a user or carrier of a medical device (cardiac pacemaker, hearing aid, implant with electronic controls etc.), you should ask your doctor or the manufacturer of the medical device if your device will function properly while using the FleetBoard vehicle computer at the same time. The manufacturers of cardiac pacemakers recommend maintaining a minimum distance of 15 cm to avoid cardiac pacemakers experiencing any malfunctions.

Transmitter frequencies

Mobile communications

3G UMTS/HSDPA/HSUPA	2G GSM/GPRS/EDGE
5-band support: <ul style="list-style-type: none"> • Band I 2100 MHz • Band II 1900 MHz • Band V 850 MHz • Band VI 800 MHz • Band VII 900 MHz 	4-band support: <ul style="list-style-type: none"> • GSM 850 MHz • E-GSM 900 MHz • DCS 1800 MHz • PCS 1900 MHz
WCDMA/HSDPA/HSUPA Power Class: <ul style="list-style-type: none"> • Power Class 3 (24 dBm) for WCDMA/HSDPA/HSUPA mode 	GSM/GPRS Power Class: <ul style="list-style-type: none"> • Power Class 4 (33 dBm) for GSM/E-GSM bands • Power Class 1 (30 dBm) for DCS/PCS bands
	EDGE Power Class: <ul style="list-style-type: none"> • Power Class E2 (27 dBm) for GSM/E-GSM bands • Power Class E2 (26 dBm) for DCS/PCS bands

Wi-Fi

Operation mode	Further details	Max. power level
IEEE hrs 802.11b	-	17 dBm
IEEE hrs 802.11g	-	14 dBm
IEEE hrs 802.11n	Channel spacing 20 MHz for 2.4GHz band	14 dBm

Operation restriction

Due to restrictions on operation in the Wi-Fi/BT range of 2.4 GHz, operation in the following countries is restricted:

- Iran
- Pakistan
- Macao
- Maldives

FleetBoard overview



- ①  Service Call button
- ② LED indicator lamp for the FleetBoard vehicle computer

The FleetBoard Truck Data Center 6 (DTCO) is the vehicle computer for FleetBoard. It is fitted in the vehicle and is not visible in the cab itself. The Service Call button is fitted in the instrument panel with the vehicle computer. It allows for remote readout of the vehicle fault memory throughout Europe by Mercedes-Benz Service 24h.

A digital tachograph and the corresponding basic wiring is required to operate the FleetBoard Truck Data Center 6 (DTCO). A valid framework agreement with appropriate service booking is required to use the FleetBoard services. The FleetBoard Truck Data Center 6

(DTCO) is a prerequisite for using the connectivity services for FleetBoard and Mercedes-Benz.

FleetBoard services

With the FleetBoard Truck Data Center 6 (DTCO), it is possible to transfer all data generated by vehicles and drivers. A valid framework agreement with appropriate service booking is required to use the FleetBoard services.

Overview of FleetBoard services:

- **Operational analysis and reports** assists in reducing fuel consumption and wear and tear. Values such as speed, braking characteristics and average total fuel consumption identify potential improvements for a more economical driving style. This information can be summarised in the form of monthly reports including an evaluation.
- **Mapping and journey record** displays vehicle data on a digital street map which can be kept track of accurately.
- **Driver card and mass storage device download** allows the driver card and mass storage device to be downloaded automatically from the vehicle.
- **Time recording** provides an overview of the current driving and rest periods of drivers.
- **Messaging** facilitates communication between the driver and logistics via DispoPilot.guide. (The DispoPilot.guide is not included in the scope of delivery.)
- **Trailer services** links data on the truck and trailer to one another.

Sending a Service Call message

If there is an active framework agreement with an activated vehicle computer, a Service Call

can be sent to the headquarters using the FleetBoard vehicle computer.

▶ Switch the ignition lock to the drive position.

i If the green LED indicator lamp on the Service Call button goes out after lighting up at the start, the FleetBoard vehicle computer is ready for operation.

▶ **To send a Service Call message/to activate roadside assistance:** press the  button for approximately 2 seconds. The LED indicator lamp flashes orange. The FleetBoard vehicle computer generates the data to be sent; this takes approximately 3 minutes. Leave the ignition switched on while the data is being sent. When the Service message has been successfully sent, the LED indicator lamp lights up green for approximately 4 seconds. The roadside assistance data is now available to Mercedes-Benz Service.

- ▶ Turn ignition lock to position **0**.
- ▶ Contact Mercedes-Benz Service (Customer Assistance Centre or national organisation).

If the LED indicator lamp flashes red for approximately 4 seconds, the service message was not sent. In this case:

- ▶ Change the vehicle location.
- ▶ Send the Service message again.

Reading out the driver card and sending the data



Driver card (example) (source: FM TA)

The data from the digital tachograph is stored on the driver card. This data will be automatically transmitted from the FleetBoard vehicle computer to the FleetBoard Service Centre. Once the data has been transmitted, the central fleet office can download the data from the FleetBoard Service Centre via the Internet. The data must be made available to the authorities if requested.

You can use the driver card for unambiguous identification of the driver.

Avoid touching the contact surface points of the memory chip with your fingers. Errors could otherwise occur when reading the memory chip.

LED indicator lamp display

The status of the FleetBoard vehicle computer can be read out on the LED indicator lamp below the Service Call button.

i If the FleetBoard vehicle computer is not activated, the LED indicator lamp lights up green and then goes out when the ignition is switched on.

LED indicator lamp	Meaning
Flashes green	The FleetBoard vehicle computer starts up. The process can last several minutes.
Lights up green for approximately 4 seconds and then goes out	The FleetBoard vehicle computer is ready for operation.
Lights up continuously in red	The FleetBoard vehicle computer has detected a fault and is no longer functioning. <ul style="list-style-type: none"> ▶ Turn the ignition off and then on again. ▶ Check the display in the on-board computer in the Diagnosis menu. ▶ If the problem persists: call FleetBoard support (> page 147)

Free and open source software

Information on licences for the free and open source software used in your device can be found on this website:

<http://www.fleetboard.com/license>

FleetBoard Truck Data Center 6 (FB Card)

Equipment

This Supplement describes the FleetBoard vehicle computer with all standard and optional equipment available at the time of going to print. Country-specific deviations are possible. Bear in mind that the FleetBoard computer may not be equipped with all of the functions described. This also applies to safety-relevant systems and functions. The equipment level of your FleetBoard vehicle computer may therefore differ to what is shown in some of the descriptions and illustrations. Contact a Mercedes-Benz Service Centre if you have any questions about equipment or operation.

Declaration of conformity

Simplified EU declaration of conformity

Hereby, Daimler AG declares that the radio equipment type CTPDIN is in compliance with Directive 2014/53/EU. The full text of the EU declaration of conformity is available at the following internet address: <https://www.fleetboard.info/license>

Electromagnetic compatibility

The electromagnetic compatibility of the vehicle components has been checked and certified according to the currently valid version of Directive ECE-R 10.

Safety notes on electromagnetic fields

The FleetBoard vehicle computer receives and transmits radio waves when in operation. The FleetBoard vehicle computer was constructed and manufactured so that it does not exceed the limiting values recommended by the International Commission on Non-Ionizing Radiation Protection (ICNIRP) for exposure to radio waves.

Notes on radio malfunctions and interferences

Radio malfunctions can be caused by any device which emits electromagnetic signals. Due to the wide range of devices which transmit and receive radio waves, overlapping radio waves can also cause malfunctions. If you are a user or carrier of a medical device (cardiac pacemaker, hearing aid, implant with electronic controls etc.), you should ask your doctor or the manufacturer of the medical device if your device will function properly while using the FleetBoard vehicle computer at the same time. The manufacturers of cardiac pacemakers recommend maintaining a minimum distance of 15 cm to avoid cardiac pacemakers experiencing any malfunctions.

Transmitter frequencies

Mobile communications

3G UMTS/HSDPA/HSUPA	2G GSM/GPRS/EDGE
5-band support: <ul style="list-style-type: none"> • Band I 2100 MHz • Band II 1900 MHz • Band V 850 MHz • Band VI 800 MHz • Band VII 900 MHz 	4-band support: <ul style="list-style-type: none"> • GSM 850 MHz • E-GSM 900 MHz • DCS 1800 MHz • PCS 1900 MHz
WCDMA/HSDPA/HSUPA Power Class: <ul style="list-style-type: none"> • Power Class 3 (24 dBm) for WCDMA/HSDPA/HSUPA mode 	GSM/GPRS Power Class: <ul style="list-style-type: none"> • Power Class 4 (33 dBm) for GSM/E-GSM bands • Power Class 1 (30 dBm) for DCS/PCS bands
	EDGE Power Class: <ul style="list-style-type: none"> • Power Class E2 (27 dBm) for GSM/E-GSM bands • Power Class E2 (26 dBm) for DCS/PCS bands

Wi-Fi

Operation mode	Further details	Max. power level
IEEE hrs 802.11b	-	17 dBm
IEEE hrs 802.11g	-	14 dBm
IEEE hrs 802.11n	Channel spacing 20 MHz for 2.4GHz band	14 dBm

Operation restriction



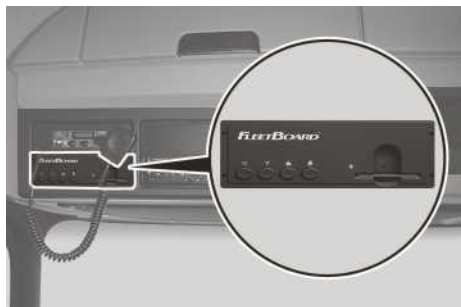

Due to restrictions on operation in the Wi-Fi/BT range of 2.4 GHz, operation in the following countries is restricted:

- Iran
- Pakistan
- Macao
- Maldives

FleetBoard overview





- ① FleetBoard vehicle computer
- ② Card slot (FleetBoard DriverCard)
- ③ LED indicator lamp
- ④  Home-Call button
- ⑤  Event-Call button
- ⑥  Service-Call button
- ⑦  Inoperative

The FleetBoard Truck Data Center 6 (FB card) is the vehicle computer for FleetBoard. It is fitted in the vehicle and is visible in the cab.

The corresponding basic wiring is required to operate the FleetBoard Truck Data Center 6 (FB card). A valid framework agreement with a respective service booking is required for use of the FleetBoard services. The FleetBoard Truck Data Center 6 (FB card) is a prerequisite for using connectivity services for FleetBoard.

FleetBoard services

With the FleetBoard Truck Data Center 6 (FB card), it is possible to transfer all data generated by vehicles and drivers. A valid framework agreement with a respective service booking is required for use of the FleetBoard services.

Overview of FleetBoard services:

- **Operational analysis and reports** assists in reducing fuel consumption and wear and tear. Values such as speed, braking characteristics and average total fuel consumption point out potential improvements for a more economical driving style. This information can be summarised in the form of monthly reports, including an evaluation.
- **Mapping and journey recording** presents vehicle data on a digital street map which can be retraced exactly.
- **Driver card and mass storage device download** allows the driver card and mass storage device to be downloaded automatically from the vehicle (a digital tachograph is required to carry out the driver card and mass storage device download).

- **Time recording** provides an overview of the current driving and rest periods of drivers.
- **Messaging** facilitates communication between the driver and logistics via DispoPilot.guide (DispoPilot.guide is not included in the scope of delivery).
- **Trailer services** links data on the truck and trailer to one another.

Inserting/removing the FleetBoard DriverCard



N54.61-2160-31

FleetBoard DriverCard

The FleetBoard DriverCard is used to identify the driver for driver-related evaluation.



Avoid touching the contact surface points of memory chip ① with your fingers. Otherwise, errors could occur when reading memory chip ①.

- ▶ Switch the ignition lock to the drive position.

Before beginning the journey/trip:

- ▶ **To insert:** insert FleetBoard DriverCard ② into the card slot of the FleetBoard vehicle computer until it engages. The lettering and memory chip ① on the FleetBoard DriverCard ② must be face up. If the FleetBoard DriverCard ② is inserted incorrectly, a warning tone sounds.

After the end of the journey/trip:



- ▶ **To remove:** remove FleetBoard DriverCard ② from the card slot.

Sending a message

With the FleetBoard vehicle computer, you can send three different messages to headquarters that have been predefined by headquarters.

► Switch the ignition lock to the drive position.

i When the green LED on the FleetBoard vehicle computer lights up permanently, the FleetBoard vehicle computer is operational.

► **To send a Home or Event-Call message:** press the  or  button on the FleetBoard vehicle computer.

The FleetBoard vehicle computer generates the data which is to be sent; this may take a few seconds.

► **To send a Service-Call message/to activate roadside assistance:** press the  button on the FleetBoard vehicle computer for approximately 2 seconds.

The LED indicator lamp flashes orange. The FleetBoard vehicle computer generates the

data which is to be sent; this may take some time. Leave the ignition switched on while the data is being sent. The green LED indicator lamp briefly flashes when the message has been successfully sent. The roadside assistance data is now available to Mercedes-Benz Service.

- Turn the ignition to position .
- Contact Mercedes-Benz Service (Customer Assistance Centre or national organisation).

If the red LED indicator lamp briefly lights up, the message has not been sent:

- Change the vehicle location.
- Send the message again.

i You will find further information on roadside assistance in the "Breakdown assistance" section (> page 369).

LED indicator lamp display

The status of the FleetBoard vehicle computer can be read out on the LED indicator lamp beside the card slot.

i If the FleetBoard vehicle computer is not activated, the LED indicator lamp is not lit up.

LED indicator lamp	Meaning
Flashes green	The FleetBoard vehicle computer starts up. The process can last several minutes.
Flashes green, until the FleetBoard vehicle computer is operational and subsequently lights up green continuously	The FleetBoard vehicle computer is ready for operation.
Lights up continuously in red	The FleetBoard vehicle computer has detected a fault and is no longer functioning. <ul style="list-style-type: none"> ► Turn the ignition off and then on again. ► If the problem persists: call FleetBoard support (> page 202).

Free and open source software

Information on licences for the free and open source software used in your device can be found on this website:

<http://www.fleetboard.com/license>

FleetBoard Support

If you have any questions regarding your FleetBoard vehicle computer or DispoPilot.guide, please consult FleetBoard Support:

Telephone

Germany/ International	+49 711 17 91 999
Austria	+43 1 36 02 77 30 24
Belgium	+32 2 62 00 453
Czech Republic	+420 22 53 76 440
Denmark (in English)	+45 35 15 80 32
Finland (in English)	+358 98 17 10 433
France	+33 1 70 48 90 88
Hungary	+36 1 32 85 340
Italy	+39 02 38 59 13 48
Luxembourg	+352 27 30 21 76
Norway (in English)	+47 23 50 01 19
Poland	+48 22 58 44 282
Romania	+402 165 507 34
Slovakia	+421 2 50 11 20 11
Spain	+34 91 37 53 353
Sweden (in English)	+46 85 19 92 272
Switzerland	+41 22 56 75 124
The Netherlands	+31 20 72 19 232

Address Daimler FleetBoard GmbH,
HPC: Z400, 70546 Stuttgart, Ger-
many

Internet <http://www.fleetboard.com>

E-mail support@fleetboard.com

Important safety notes

WARNING

If you handle or operate mobile audio/video sources while driving, your attention may be diverted from the traffic conditions. You could then lose control of the vehicle. There is a risk of an accident.

Only handle or operate these mobile audio/video sources when the vehicle is stationary. Only operate mobile audio/video sources via the communications devices integrated into the vehicle when traffic conditions permit. If this is not the case, pull over to a safe location and make entries only while the vehicle is stationary.

WARNING

If you use mobile information systems and communications devices while driving, you will be distracted from traffic conditions. You could then lose control of the vehicle. There is a risk of an accident.

Only operate these devices when the vehicle is stationary.

When using the DispoPilot.guide, observe the legal requirements of the country in which you are currently driving.

Remember that even at a speed of 50 km/h, your vehicle covers a distance of 14 m per second.

When using the device please follow:

- the safety notes in these Operating Instructions
- traffic laws and regulations
- laws pertaining to motor vehicles and safety standards

WARNING

SD cards are small parts. They can be swallowed and cause choking. This poses an increased risk of injury or even fatal injury.

Keep the SD card out of the reach of children. If a SD card is swallowed, seek medical attention immediately.

Note on the Brief Instructions

These brief instructions only describe the basic operation of your DispoPilot.

All further information on the individual functions can be found on the Internet at www.mercedes-benz.de/betriebsanleitung-lkw or in the Operating Instructions on the DispoPilot.

Declaration of conformity

Simplified EU declaration of conformity

Hereby, Daimler AG declares that the radio equipment type DispoPilot.guide is in compliance with Directive 2014/53/EU. The full text of the EU declaration of conformity is available at the following internet address: <https://www.fleetboard.info/license>

Electromagnetic compatibility

The electromagnetic compatibility of the vehicle components has been checked and certified according to the currently valid version of Directive ECE-R 10.

Safety notes on electromagnetic fields

DispoPilot.guide receives and transmits radio waves when in operation. DispoPilot.guide was constructed and manufactured so that it does not exceed the limit values recommended by the International Commission on Non-Ionizing Radiation Protection (ICNIRP) for exposure to radio waves.

Notes on radio malfunctions and interferences

Radio malfunctions can be caused by any device which emits electromagnetic signals. Due to the wide range of devices which transmit and receive radio waves, overlapping radio waves can also cause malfunctions. If you are a user or carrier of a medical device (cardiac pacemaker, hearing aid, implant with electronic controls etc.), you should ask your doctor or the manufacturer of the medical device if your device will function properly while using DispoPilot.guide at the same time. The manufacturers of cardiac pacemakers recommend maintaining a mini-

mum distance of 15 cm to avoid cardiac pace-makers experiencing any malfunctions.

Transmitter frequencies

Serial number	OC	OJ
Mobile communications		
WCDMA/HSDPA/HSUPA/ HSPA+ Power Class:	Class 3 (23.5 dBm) @ 900/2100 MHz	Class 3 (+24 dBm +1/-3 dB) for UMTS 2100, WCDMA FDD BdI Class 3 (+24 dBm +1/-3 dB) for UMTS 1900, WCDMA FDD BdII Class 3 (+24 dBm +1/-3 dB) for UMTS 900, WCDMA FDD BdVIII Class 3 (+24 dBm +1/-3 dB) for UMTS 850, WCDMA FDD BdV Class 3 (+24 dBm +1/-3 dB) for UMTS 800, WCDMA FDD BdVI
GSM/GPRS Power Class:	Class 4 (33 dBm) @ 900 MHz Class 1 (30 dBm) @ 1800 MHz	Class 4 (+33 dBm \pm 2 dB) for EGSM850 Class 4 (+33 dBm \pm 2 dB) for EGSM900 Class 1 (+30 dBm \pm 2 dB) for GSM1800 Class 1 (+30 dBm \pm 2 dB) for GSM1900
EDGE Power Class:	Class E2 (27 dBm) @ 900 MHz Class E2 (26 dBm) @ 1800 MHz	Class E2 (+27 dBm \pm 3 dB) for GSM 850 8-PSK Class E2 (+27 dBm \pm 3 dB) for GSM 900 8-PSK Class E2 (+26 dBm +3 /-4 dB) for GSM 1800 8-PSK Class E2 (+26 dBm +3 /-4 dB) for GSM 1900 8-PSK
Wi-Fi 2.4 GHz		
IEEE hrs 802.11b	13 dBm	17 dBm
IEEE hrs 802.11g	13 dBm	16 dBm
IEEE hrs 802.11n (HT20)	13 dBm	16 dBm
Wi-Fi 5 GHz		
IEEE hrs 802.11n (HT20)	n/a	17 dBm

Serial number	OC	OJ
IEEE hrs 802.11n (HT40)	n/a	16 dBm
Bluetooth® 2.4 GHz		
Bluetooth® Classic	3 dBm	3 dBm
Bluetooth® Low Energy	3 dBm	3 dBm
NFC 13.56 MHz		
	-3 dBμA/m @ 3 m	12 dBμA/m @ 3 m

Operation restriction

Operation is restricted in the following counties:

- Russian Federation

Availability

The DispoPilot.guid is offered in Mercedes-Benz vehicles as original equipment and for all brands for retrofitting.

First steps

Inserting the rechargeable battery

DispoPilot.guid is only available with a pre-installed rechargeable battery. The rechargeable battery cannot be removed. If the rechargeable battery needs to be replaced, contact FleetBoard Support.

Charging the rechargeable battery

When DispoPilot.guid is inserted into the holder and the vehicle ignition is switched on, the DispoPilot.guid rechargeable battery automatically charges.

When DispoPilot.guid is not inserted into the holder, you can charge DispoPilot.guid using the micro USB port (▷ page 207).

Inserting and removing DispoPilot.guid

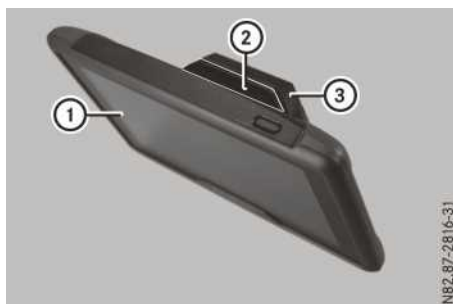

- ① DispoPilot.guid
- ② Release button
- ③ Holder

- ▶ **To insert:** insert DispoPilot.guid ① at the bottom of the holder and then press it back until DispoPilot.guid engages.
- ▶ **To remove:** press release button ② and pull DispoPilot.guid ① out of holder ③ forwards.

- i** If you remove DispoPilot.guid from the vehicle and insert it into the holder in another vehicle, current orders and messages in the device are lost.

Overview

Operating system

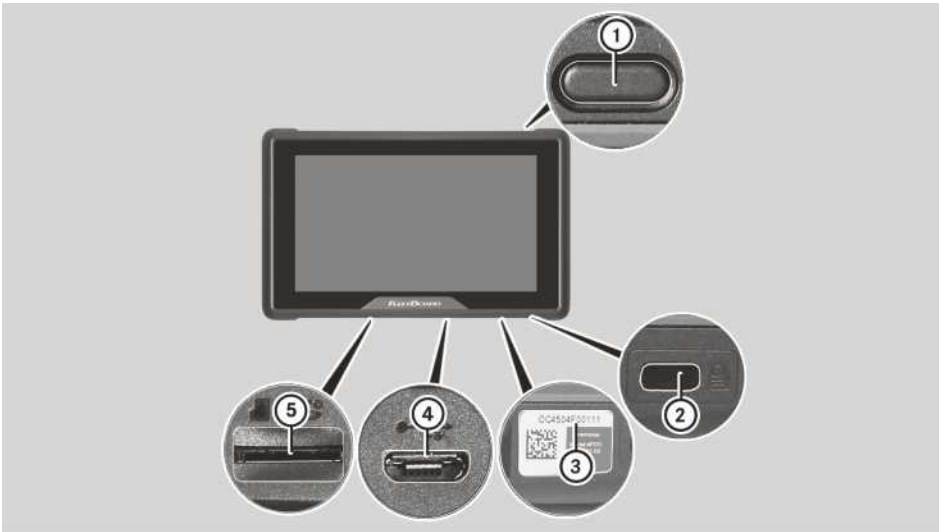

- ① To switch DispoPilot.guide on/off
- ② Slot for Kensington lock
- ③ DispoPilot.guide serial number
- ④ Micro USB port (only for charging the rechargeable battery)
- ⑤ Card slot for microSD card

Homepage

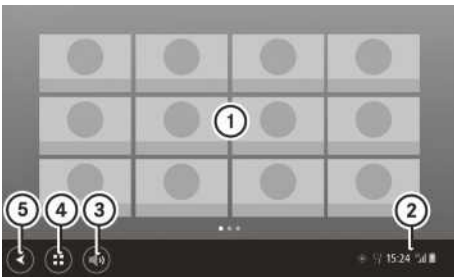

- ① FleetBoard portal homepage
- ② Status indicator (GPS status, connection status, time, GSM status, charge status)
- ③ Adjusting the volume
- ④ To call up the FleetBoard application
- ⑤ To return to the previous screen

Connection status overview

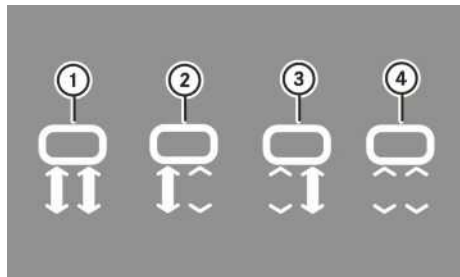

- ① Vehicle computer and FleetBoard Server connected
- ② Vehicle computer connected, FleetBoard Server not connected
- ③ Vehicle computer not connected, FleetBoard Server connected
- ④ Vehicle computer and FleetBoard Server not connected

i The connection status in the display shows whether DispoPilot.guide is connected to the vehicle computer and FleetBoard Server. If there is no connection to the FleetBoard Server, no messages or orders can be transmitted. If there is no connection to the vehicle computer, navigation will not work.

Basic functions

Switching on/off

When the DispoPilot.guide is in the holder, the DispoPilot.guide is automatically switched on and off with the vehicle's ignition. You can also manually switch the DispoPilot.guide on and off.

- ▶ **To switch on manually:** briefly press the on/off button.
After switching on, the start screen appears.
- ▶ Confirm the start screen with **OK**.
- ▶ **To switch off manually:** press and hold the on/off button until a menu appears.
- ▶ Select **Switch off**.

Using the screen

General note

Do not press your fingers too hard on the screen. This can result in a malfunction.

Moving the view

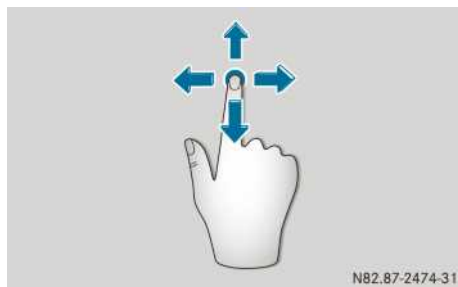

- ▶ Touch the touch-sensitive surface with one finger.
- ▶ Swipe up, down, to the left or to the right.
The selection in the display moves according to the direction of the movements.

This allows you to navigate through lists or menus or move the map.

Rapid view change

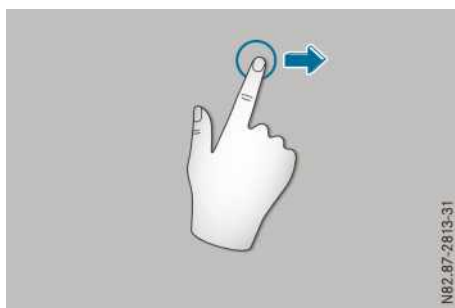

- ▶ Touch the touch-sensitive surface with one finger and quickly swipe it to the left or right.
The selection in the display quickly moves according to the direction of movement.

This allows you to navigate through lists or menus or move the map.

Confirming the selection



- ▶ Press the touch-sensitive surface with one finger until the point of resistance is reached.
A menu item or option is selected.

Opening the menu

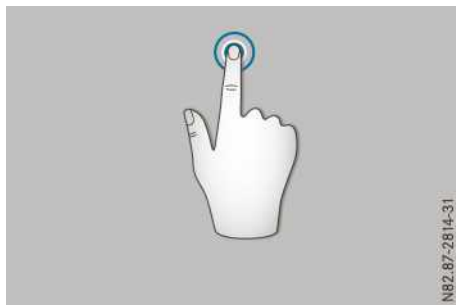

N82.87-2814-31

- ▶ Press and hold the touch-sensitive surface with one finger until the menu opens.

Rapidly zooming in on the map

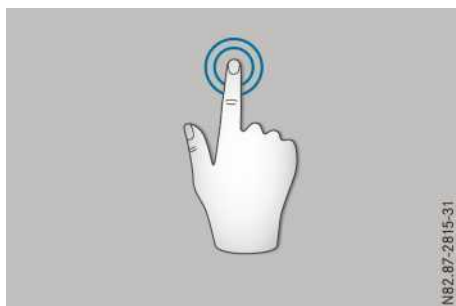

N82.87-2815-31

- ▶ Rapidly press the touch-sensitive surface with one finger twice.
The view will zoom in.

Zooming in on the map



N82.87-2481-31

- ▶ Place two fingers a short distance apart on the touch-sensitive surface.
- ▶ Slide your fingers apart.
The map will zoom in.

Zooming out of the map

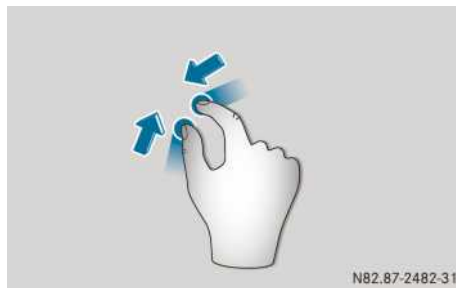

N82.87-2482-31

- ▶ Place two fingers a larger distance apart on the touch-sensitive surface.
- ▶ Slide your fingers together.
The map will zoom out.

Navigation

Important safety notes

WARNING

If you operate information and communication equipment integrated in the vehicle when driving, you could be distracted from the traffic situation. This could also cause you to lose control of the vehicle. There is a risk of an accident.

Only operate this equipment when the traffic situation permits. If you cannot be sure of this, stop the vehicle paying attention to road and traffic conditions and operate the equipment with the vehicle stationary.

You must observe the legal requirements for the country in which you are currently driving when operating the system.

The navigation system calculates the route to the destination without taking into account, for example:

- traffic lights
- stop signs and right-of-way signs
- parking and stopping restrictions
- lane narrowings
- other road and traffic rules and regulations

The navigation system may provide incorrect driving recommendations if the surroundings do not correspond to the data on the digital map.

For example, if the routing or the direction of a one-way street has been changed.

For this reason, you must always observe road and traffic rules and regulations during your journey. Traffic regulations always take precedence over the navigation system's recommendations.

Calling up menus in the navigation system

Calling up the navigation system menu

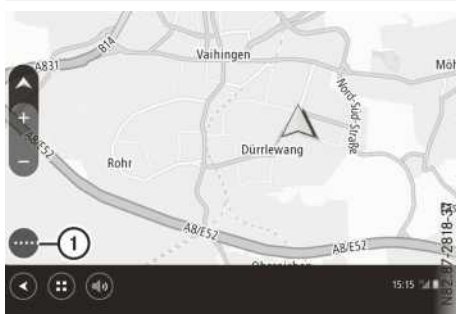

① To call up the navigation system menu

Options in the navigation menu

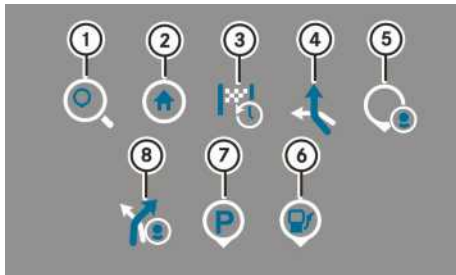

- ① To search for an address, a position or a POI
- ② To navigate home
- ③ To call up previous destinations
- ④ To change or delete the current route
- ⑤ To display stored locations
- ⑥ To search for petrol stations
- ⑦ To search for a parking space
- ⑧ To display stored routes

Calling up the submenu



① To call up the submenu

When a location or a route is selected on the map, the submenu is available.

Entering a destination

Overview of entering a destination



- ① Entry line
- ② To select search area
- ③ To switch to map or route view (cancel search)
- ④ To scroll through the list
- ⑤ To show the keypad
- ⑥ To switch between list view and map view
- ⑦ POI categories or POI results list
- ⑧ Address results list

► Enter characters using the keypad.
Results matching the current entry appear on results lists ⑦ and ⑧.

You can search for a destination:

- on the entire map.
- near the current vehicle position.
- in a location or a town.

- along the route.
- near the destination.

Example of selecting a destination with the address:

- ▶ Call up the navigation system menu.
- ▶ Select **Search**.
An input menu appears.
- ▶ Enter the desired address.
- ▶ Select the desired location from the results list.
- ▶ **To select a junction:** select **Junction**.
- ▶ **To display a location on the map:** select **Display on the map**.
- ▶ **To calculate a route:** select **Drive**.
The route to the destination appears on the map.
- ▶ **To start route guidance:** select **Let's go...**
The route view appears as soon as the vehicle sets off.

Planning a route

- ▶ **To specify the starting point:** enter the desired starting point.
The location appears on the map.
- ▶ Call up the submenu.
- ▶ Select **Use as starting point**.
- ▶ **To specify the destination:** select the desired destination.
The destination appears on the map.
- ▶ Select **Drive**.
The route is calculated.
- ▶ **To select the current position as the starting point:** select the starting point on the route.
- ▶ Call up the submenu.
- ▶ Select **Remove starting point**.
The route is recalculated with the current vehicle position as the starting point.
- ▶ **To convert the starting point into a stopover:** select the starting point in the route.
- ▶ Call up the submenu.
- ▶ Select **Convert into a stop**.

- ▶ **To specify a stopover:** enter the desired stopover.
The destination appears on the map.
- ▶ Select **Add to "Current route"**.
Stopovers are added to the route in the order they are entered.

During route guidance

Route overview

When a route has been calculated, the complete route appears as an overview on the map.



- ① Destination
- ② Traffic disruption
- ③ Stopover
- ④ Route bar
- ⑤ Current vehicle position
- ⑥ Planned route
- ⑦ To call up the navigation system menu
- ⑧ Map zoom
- ⑨ To switch between north orientation and heading orientation

Display during route guidance (route view)

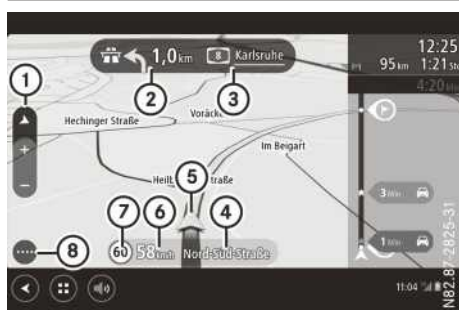

- ① To switch between 2D and 3D view
- ② Next change of direction and distance to change of direction
- ③ Next street
- ④ Current street
- ⑤ Current vehicle position
- ⑥ Current vehicle speed
- ⑦ Speed limit (when available)
- ⑧ To call up the navigation system menu

Displays on the route bar



Example of a wider route bar

- ① Current distance to destination, estimated time of arrival at the destination and current journey time to destination
 - ② Total delay on the route
 - ③ Filling station on the route
 - ④ Traffic disruption (alternately type of traffic disruption and delay in minutes)
 - ⑤ Progress bar
 - ⑥ Stopover
- i** The progress bar shows a simplified view of the vehicle's current location on the route. The progress bar also shows intermediate

destinations and traffic messages on the route. Only the next 50 km will be displayed for roads longer than 50 km. To display the entire route, the progress bar can be moved.

Lane recommendations

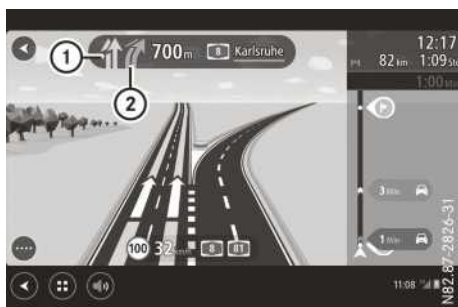

- ① Recommended lane (highlighted in colour)
- ② Lane not recommended (grey)

If the digital map contains the corresponding data, lane recommendations for upcoming changes of direction can be displayed before motorway exits and junctions.

Route restrictions

When the vehicle type is set to "Bus" or "Truck" in the vehicle profile, route restrictions will be displayed in the route view during the journey. Streets with restricted access are marked in colour. Streets with restricted access on the route appear as a dotted line on the map.

- i** Observe all the traffic signs at all times. Pay particular attention to signs with restrictions that refer to the dimensions and weight of the vehicle. The route can contain restrictions.

Quick access

With quick access, you can mark the location, avoid closed roads or display the current vehicle position and the longitude and latitude. To open the quick access menu, select the symbol for the current vehicle position or the speed display.

Practical advice

Reset

When DispoPilot.guide no longer reacts to entries, the software needs to be restarted.

- **To perform a restart:** press and hold the on/off button until DispoPilot restarts.

Cleaning

Clean the housing and the touchscreen regularly with a soft cloth. Do not use abrasive or aggressive cleaning products such as solvents.

Do not use chemical cleaners or cleaning materials that could scratch the surface of the touchscreen.

Replacing the rechargeable battery

♻️ Protection of the environment

Rechargeable batteries contain pollutants. Do not dispose of old batteries with household waste.

Dispose of rechargeable batteries in an environmentally responsible manner at a specialist workshop, a Mercedes-Benz Service Centre or a collection point.

DispoPilot.guide is only available with a pre-installed rechargeable battery. The rechargeable battery cannot be removed. If the rechargeable battery needs to be replaced, contact FleetBoard Support.

FleetBoard Support

If you have any questions regarding your FleetBoard vehicle computer or DispoPilot.guide, please consult FleetBoard Support:

Telephone

Germany/ International	+49 711 17 91 999
Austria	+43 1 36 02 77 30 24
Belgium	+32 2 62 00 453
Czech Republic	+420 22 53 76 440

Denmark (in English)	+45 35 15 80 32
Finland (in English)	+358 98 17 10 433
France	+33 1 70 48 90 88
Hungary	+36 1 32 85 340
Italy	+39 02 38 59 13 48
Luxembourg	+352 27 30 21 76
Norway (in English)	+47 23 50 01 19
Poland	+48 22 58 44 282
Romania	+402 165 507 34
Slovakia	+421 2 50 11 20 11
Spain	+34 91 37 53 353
Sweden (in English)	+46 85 19 92 272
Switzerland	+41 22 56 75 124
The Netherlands	+31 20 72 19 232

Address Daimler FleetBoard GmbH,
HPC: Z400, 70546 Stuttgart, Germany

Internet <http://www.fleetboard.com>

E-mail support@fleetboard.com

Important safety notes

WARNING

The CD/DVD drive is a class 1 laser product. If you open the housing of the CD/DVD drive, invisible laser beams may be released. These laser beams may damage your retina. There is a risk of injury.

Do not open the housing. Always have maintenance work and repairs carried out at a qualified specialist workshop.

WARNING

If you handle a disc while driving, you may be distracted from the traffic situation. This could also cause you to lose control of the vehicle. There is a risk of an accident.

Only handle a disc when the vehicle is stationary.

WARNING

If you operate information and communication equipment integrated in the vehicle when driving, you could be distracted from the traffic situation. This could also cause you to lose control of the vehicle. There is a risk of an accident.

Only operate this equipment when the traffic situation permits. If you cannot be sure of this, stop the vehicle paying attention to road and traffic conditions and operate the equipment with the vehicle stationary.

You must observe the legal requirements for the country in which you are currently driving when operating the system.

WARNING

If you use mobile information systems and communications devices while driving, you will be distracted from traffic conditions. You could then lose control of the vehicle. There is a risk of an accident.

Only operate these devices when the vehicle is stationary.

WARNING

If you handle or operate mobile audio/video sources while driving, your attention may be diverted from the traffic conditions. You could then lose control of the vehicle. There is a risk of an accident.

Only handle or operate these mobile audio/video sources when the vehicle is stationary.

Only operate mobile audio/video sources via the communications devices integrated into the vehicle when traffic conditions permit. If this is not the case, pull over to a safe location and make entries only while the vehicle is stationary.

WARNING

If you operate two-way radios incorrectly in the vehicle, their electromagnetic radiation can interfere with the vehicle electronics, for example if:

- the two-way radio is not connected to an exterior aerial
- the exterior aerial is not correctly mounted or is not low-reflection

This could jeopardise the operating safety of the vehicle. There is a risk of an accident.

Have the low-reflection exterior aerial fitted at a qualified specialist workshop. When operating two-way radios in the vehicle, always connect them to the low-reflection exterior aerial.

General notes

These brief instructions only describe the basic operation of your audio system.

The brief instructions include the following device variants:

- radio/navigation system, Bluetooth®, Comfort (below, "radio/navigation system")
- CD radio, Bluetooth®, CD radio, Bluetooth®, Comfort (below, "CD radio")
- radio with USB port, CD radio (below, "radio")

All further information on the individual functions can be found on the Internet at

www.mercedes-benz.de/betriebsanleitung-lkw or in the Digital Operating Instructions (radio/navigation system only).

Anti-theft protection

When switching on for the first time or after the battery has been disconnected **Disabled**.

Please switch on ignition. or **Disabled, please switch on ignition** or **BLOCKED** appears in the audio system display.



- ▶ Switch on the ignition.
You can now use the audio system.



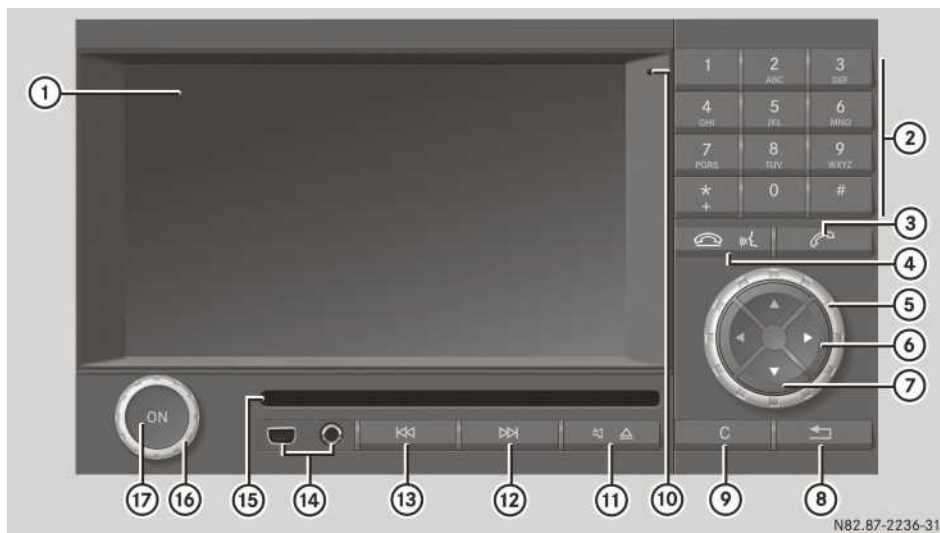

Operating system











Radio/navigation system overview



N82.87-2236-31

	Function	Page
①	Display	218
②	Number pad To set a station via the station presets To store stations manually To enter a passkey To enter the telephone number To enter characters	233
③	 To accept a call To dial a number To switch to telephone mode from another operating mode	
④	 /  To reject a call To end an active call To activate the voice control system	







	Function	Page
⑤	Turn  the controller: To select a station To select a list item To adjust the map scale To change the adjustment value Press  the controller briefly: To confirm your selection To display stored stations To display playback options To display the map in full-screen Press and hold  the controller: To start route guidance directly from a list	221 221 221
⑥	  Horizontal arrow buttons: To select a main function To move the map horizontally (in full-screen display) To select a DVD menu item	

	Function	Page
⑦	  Vertical arrow buttons: To select a function from the submenu To move the map vertically (in full-screen display) To select a DVD menu item	
⑧	 Press the back button briefly: To move up one menu level  Press and hold: To jump to the highest menu level for the selected main function	
⑨	 Press the delete button briefly: To delete characters To exit the settings menu without making any changes  Press and hold: To delete entries	
⑩	Microphone	
⑪	 /  Press the mute/eject button briefly: To mute To switch off the traffic and navigation announcements To pause CD, DVD or USB playback  /  Press and hold: to eject a CD/DVD	

Radio/navigation system function overview

You can use the radio/navigation system to operate the following main functions:

- audio mode with the radio, audio CD/DVD and MP3 mode, USB audio, Bluetooth® audio and audio AUX operating modes
- the navigation system (destination entry, tour entry, traffic messages, navigation settings)
- the phone via Bluetooth® (making a call, phone book, call lists)

	Function	Page
⑫	 Press briefly: To select stations using the station search function To select the next track  Press and hold: Fast forward Manual station search	
⑬	 Press briefly: To select stations using the station search function To select the previous track  Press and hold: Fast rewind Manual station search	
⑭	Mini USB socket and AUX jack	
⑮	Disc slot To insert CDs/DVDs To remove CDs/DVDs	
⑯	 Turn: to adjust volume	
⑰	 Press: to switch radio/navigation system on/off	

- the video DVD function and the video/AUX inputs
- Digital Operating Instructions (keyword search, visual search, contents, article page, help)
- the settings (sound, language, display, Bluetooth®, system)





Radio/navigation system display overview







- ① Status bar
- ② Menu path display
- ③ Main function bar; the current main function is highlighted in blue
- ④ Selected list entry
- ⑤ Display/selection window (here, town selection list)
- ⑥ Submenu of the selected main function (here, navigation)

Radio/navigation system menu overview





Main function audio

-  Radio
-  CD/DVD playback
-  USB audio
-  Bluetooth® audio
- AUX** AUX audio



Main function navigation

-  Basic display with map
-  Destination entry
-  Trip entry
-  Traffic announcements
-  Navigation settings





Main function telephone

-  Basic display with keypad
-  Phone book
-  Unanswered calls
-  Accepted calls
-  Dialled numbers





Main function video

-  DVD playback
-  Video/AUX in sockets

Main function Digital Operating Instructions

-  Keyword search
-  Visual search
-  Contents
-  Article page
-  Help



Main function settings



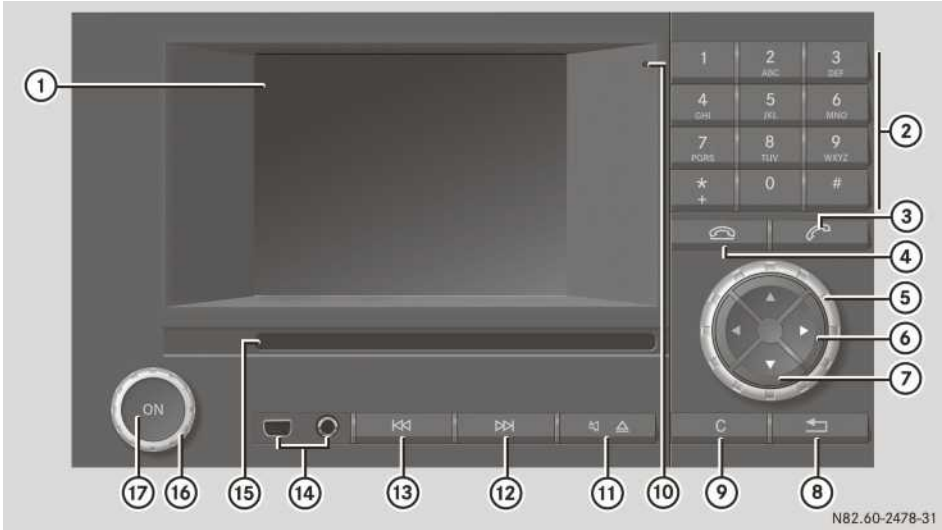





-  Audio settings
-  Language settings
-  Display settings
-  Bluetooth® settings
-  System settings









CD radio overview



N82.60-2478-31

	Function	Page
①	Display	220
②	Number keypad: To set a station via the station presets To store stations manually To enter a passkey To enter the telephone number To enter characters	233
③	 To accept a call To dial a number To select telephone mode	
④	 To reject a call To end an active call	
⑤	Turn  the controller: To select a station To select a list item To change the adjustment values	221

	Function	Page
	Press  the controller: To confirm your selection To display stored stations To display playback options	221
⑥	  Horizontal arrow buttons: To select a main function	
⑦	  Vertical arrow buttons: To select a function from the submenu	
⑧	 Press the back button briefly: To move up one menu level  Press and hold: To jump to the highest menu level for the selected main function	
⑨	 Press the delete button briefly: To delete characters  Press and hold: To delete an entry	
⑩	Microphone	

	Function	Page
11	 /  Press the mute/eject button briefly: To mute To switch off traffic announcements  /  Press and hold: To eject a CD	
12	 Press briefly: To select stations using the station search function To select the next track  Press and hold: Manual station search Fast forward	
13	 Press briefly: To select stations using the station search function To select the previous track  Press and hold: Manual station search Fast rewind	



CD radio function overview

You can use the CD radio to operate the following main functions:

- audio mode with the radio, audio CD/DVD and MP3 mode, USB audio, Bluetooth® audio and audio AUX operating modes
- the phone via Bluetooth® (making a call, phone book, call lists)
- the settings (sound, language, display, Bluetooth®, system)

CD radio display overview

The display shows the currently selected function and its associated menus. The display is divided into several areas.

	Function	Page
14	Mini USB socket and AUX jack	
15	Disc slot: To insert CDs To remove CDs	
16	 Turn: To adjust the volume	
17	 Press: To switch the CD radio on/off	



N82.60-2482-31

Example: MP3 playback function in CD mode

- ① Main function bar, current main function is highlighted (audio in the example)
- ② Status symbols
- ③ Submenu of the selected main function
- ④ Selected list entry
- ⑤ The currently active option is marked with a dot
- ⑥ Submenus

CD radio menu overview

Main function radio

- Switching FM stations/traffic announcement priority on/off
- Switching automatically stored FM stations/traffic announcement priority on/off
- Switching between AM stations/wavebands
- Switching between automatically stored AM stations/wavebands

Main function audio

- CD playback (audio CD and MP3 CDs)
- USB audio
- Bluetooth® audio
- AUX

Main function telephone

- Basic display
- Phone book
- Missed calls
- Accepted calls
- Dialed numbers

Main function sound settings

- Treble
- Bass
- Mid-range
- Balance
- 3D sound

Main function settings



- Language
- Display brightness
- Bluetooth® settings
- System settings

Radio/navigation system and CD radio controller



Example: operating the controller

Using the controller you can:

- press briefly or press and hold 
- turn clockwise or anti-clockwise 

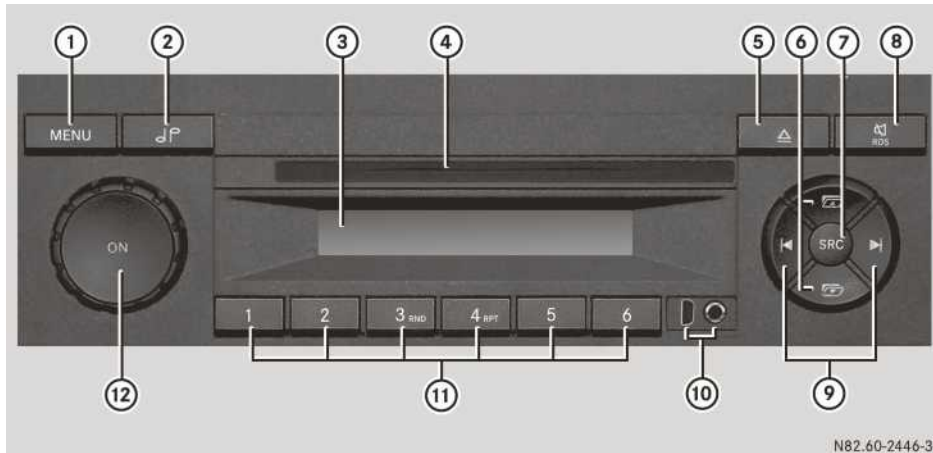

Radio overview



N82.60-2446-31

	Function	Page
①	MENU To select a menu In CD/USB mode: to switch to the track time display	
②	To select the sound menu	
③	Display	
④	Disc slot: To insert CDs To remove CDs	
⑤	Equipment with CD drive: Eject button: To eject a CD Equipment without CD drive: RDS button In radio mode: to switch the RDS convenience function on/off	
⑥	Scroll buttons: In radio mode: to change waveband In MP3 mode (CD or USB): to change folder In AUX mode: to switch between FRONT and REAR MAN	



	Function	Page
⑦	SRC source button: To select an audio source Press and hold: A-STORE To mute the current traffic announcement	223
⑧	Mute button: To end the current traffic message Equipment with CD drive: Press briefly: To mute the audio source (mute/pause) Press and hold: In radio mode: to switch the RDS convenience function on/off Equipment without CD drive: To mute the audio source (mute/pause)	

	Function	Page
⑨	  Arrow buttons In radio mode: Press briefly: to start station search Press and hold: manual station search In CD/USB mode: Press briefly: to skip to the next/previous track Press and hold: fast forward/rewind	
⑩	Mini USB socket and AUX jack	
⑪	Number pad In radio mode: Press briefly: to select the station from the station memory Press and hold: to store a station manually In CD/USB mode: Button 3 (RND): to switch random playback on/off or to switch between random playback modes Button 4 (RPT): to switch repeat track on/off or to switch between repeat modes	

Radio function overview





You can use the radio to operate the following functions:

- radio with the wavebands: FM, AM (medium wave, short wave and long wave)
- audio CD playback (only on equipment with a CD drive)
- MP3 playback from CD (only on equipment with a CD drive)
- MP3 playback from USB audio devices
- audio equipment playback via the AUX jack
- settings (sound, traffic announcements, Radio Data System)



	Function	Page
⑫	 Press the control knob: To switch audio equipment on/off  Turn: To adjust the volume	



Audio mode



Radio/navigation system

- ▶ Press the  or  button repeatedly until  (Audio) is selected in the main function bar.
The audio submenu that you last used appears.
- ▶ Press the  or  button in the audio submenu to select the desired audio source (radio, CD/DVD, USB, Bluetooth®, AUX).

CD radio

► **To select Radio:** press the  or  button repeatedly until  (Radio) is selected in the main function bar. The radio basic display appears. You will hear the last station played.

► **To select another audio source:** press the  or  button repeatedly until  (Audio) is selected in the main function bar. The audio submenu that you last used appears.

► Press the  or  button in the audio submenu to select the desired audio source (CD, USB, Bluetooth®, AUX).

Radio

► Press the **SRC** button repeatedly until the desired audio source (radio, CD/MP3, USB, AUX) is shown in the display.

Bluetooth® settings

Notes on the Bluetooth® function

You can connect a Bluetooth®-capable device to the radio/navigation system and the CD radio. Telephony via the radio/navigation system and the CD radio is available in conjunction with a Bluetooth®-capable phone.

More information on suitable mobile phones and on connecting Bluetooth®-capable mobile phones with the audio system can be obtained:

- from your Mercedes-Benz Service Centre or
- on the Internet at <http://www.mercedes-benz.com/connect>









Requirements for a Bluetooth® connection

The following requirements must be met in order for the audio system to detect the Bluetooth® device:

- Mobile phones must support Hands Free Profile 1.0 or above.
- Every Bluetooth® device has its own Bluetooth® name which you can assign yourself.
- The Bluetooth® device is located inside the vehicle in the vicinity of the audio system.

- Bluetooth® must be activated on both the audio system and on the respective Bluetooth® device.
- The Bluetooth® device must be "visible" (see the manufacturer's operating instructions).



Activating or deactivating the Bluetooth® function

- Press the  or  button repeatedly until  (system settings) is selected in the main function bar. The last used settings menu appears.
- Select the Bluetooth® settings menu using the  or  button.
- Turn  the controller to select **Activate Bluetooth/Bluetooth on**.
- Press  the controller. If ticked , the function is activated.

Connecting Bluetooth® devices

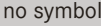
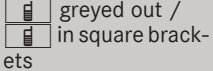

- **To call up the Bluetooth® device list:** turn  the controller to select **List of BT cell phones/Phone list** or **List of BT audio players/Audio device list**.
- Press  the controller. The list of the Bluetooth® devices appears.



The status of the listed devices may differ as follows (visible by the symbol):



	devices within range which have not yet been authorised
	devices out of range which have been authorised
	devices within range which have been authorised but are not connected
	devices within range which are authorised and connected

- For Bluetooth® audio devices, you will see a musical note symbol instead of a telephone symbol.

If the desired Bluetooth® device is not in the list, you must update the list.

- ▶ Turn  the controller to select **Update**.
- ▶ Press  the controller.

The audio system searches for Bluetooth® devices within range. This procedure may take some time. Once the search is completed, the audio system updates the device list.
- ▶ **To authorise a Bluetooth® device (registering):** turn  the controller to select a device which has not yet been authorised in the Bluetooth® device list.
- ▶ Press  the controller.

The Bluetooth® functions menu for the selected device appears.
- ▶ Turn  the controller to select **Authorise**.
- ▶ Press  the controller.

An enquiry dialogue appears asking you if you are sure that you want to authorise the device.
- ▶ Select **Yes** using  the controller.





The dialogue for entering a passkey appears.
- ▶ Use the audio system number keypad to enter a number with that can be easily memorised, e.g. 1111.
- ▶ Turn  the controller to confirm **OK**.

A request for the passkey to be entered appears in the Bluetooth® device.
- ▶ Enter the same passkey on the Bluetooth® device as on the audio system and confirm.

Radio/navigation system: the Bluetooth® device is authorised and immediately connected.

CD radio: the Bluetooth® device is authorised. After the Bluetooth® device has been successfully authorised, it also needs to be connected.

Connecting a device to the CD radio:

- ▶ In the telephone or audio devices list, use  the controller to select the desired device.
- ▶ Press  the controller.
- ▶ Turn  the controller to select **Connect**.
- ▶ Press  the controller.

An enquiry dialogue appears, asking you if you are sure that you want to connect the device.
- ▶ Select **Yes** using  the controller.

Your Bluetooth® device is now connected and operational via the audio system and operational with it.

Navigation

Important safety notes

WARNING

Operating the integrated information systems and communications equipment in the vehicle while driving will distract you from traffic conditions. You could then lose control of the vehicle. There is a risk of an accident.

Only operate these devices if road traffic conditions permit. If you are unsure about the surrounding conditions, pull over to a safe location and make entries only while the vehicle is stationary.

The navigation system calculates the route to the destination without taking into account, for example:

- traffic lights
- stop signs and right-of-way signs
- parking and stopping restrictions
- lane narrowings
- other road and traffic controls and regulations



You must observe the legal requirements for the country in which you are currently driving when operating the system.



The driver is responsible for the safety of the vehicle at all times.

General note

Navigation is available for the radio/navigation system.



Switching on navigation mode

- ▶ Press the  or  button repeatedly until  (navigation) is selected in the main function bar.

The navigation menu that you last used appears.
- ▶ **If necessary:** press the  button to select  (map display) in the navigation submenu.

The map is shown.

Showing/hiding the menu

- ▶ **To hide the menu:** press  the controller. The map appears in the full-screen display.
- ▶ **To show the menu:** press the  back button when the map is shown in full-screen.







Destination entry

Destination entry options

The following options can be used for destination entry:

- entering an address
- selecting a destination from the destination memory
- selecting one of the last used destinations (previous destinations)
- entering a destination using the map
- selecting a destination from the POIs



Calling up the destination entry menu

- ▶ Press the  or  button repeatedly until  (navigation) is selected in the main function bar. The navigation menu that you last used appears.
- ▶ **If necessary:** select the  or  button in the  navigation submenu (destination entry). The destination input menu appears.

Example: address entry



Address input menu

Calling up the address input menu:

- ▶ In the destination entry menu, turn  the controller to select **Address input**.
- ▶ **To confirm your selection:** press  the controller.

Entering an address

Selecting a country:



- ▶ In the destination entry menu, turn  the controller to select **Country**.
- ▶ **To confirm your selection:** press  the controller.

- ▶ Turn  the controller to select the desired country.

- ▶ **To confirm your selection:** press  the controller. The character entry menu for entering the town appears.

- ▶ Enter the first letters of the desired town.



Once the number of towns that begin with the entered letters is small enough, the selection list appears automatically. However, you can also switch to the list display in advance by pressing and holding the controller in the character entry menu or by selecting **OK** and confirming.

- ▶ Turn  the controller to select the desired list entry.
- ▶ **To confirm your selection:** press  the controller. The address input menu appears.

Selecting the street:

- ▶ In the address input menu, turn  the controller to select **Street**.

- ▶ **To confirm your selection:** press  the controller. The street list appears immediately for smaller towns. For larger towns, the character entry menu appears first and the street list only appears after the first letters of the desired street have been entered.

- ▶ Turn  the controller to select the desired street.
- ▶ **To confirm your selection:** press  the controller. The address entry menu appears again.

You can start route guidance. The destination is then the centre of the selected town. However, the **Street**, **House number** or **Junction** can be entered first. Proceed in the same way as for the street name entry.

Route guidance

General notes

Navigation announcements should guide you during the journey without distracting you from traffic conditions or driving. Always listen to the navigation announcements rather than using the map display for orientation.

Starting route guidance

- ▶ In the address input menu, turn **[⊙]** the controller to select **Start route guidance**.
- ▶ **To confirm your selection:** press **⊙** the controller.

Cancelling route guidance

- ▶ Turn **[⊙]** the controller to select **Cancel route guidance** from the function menu.
- ▶ **To confirm your selection:** press **⊙** the controller.
The map appears in full screen mode without active route guidance.

Displays during route guidance

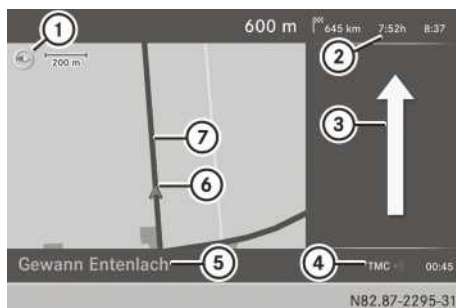

Example: full-screen mode with split screen and active route guidance

- 1 Map orientation (here: north-up), to the right of the adjusted scale
- 2 Information on the destination (distance from destination, estimated duration of journey, estimated time of arrival)
- 3 Arrow indicating the direction of travel during change of direction
- 4 TMC indicator¹
- 5 Current road (if available) or geo-coordinates
- 6 Current vehicle position and direction of travel
- 7 Route (highlighted in colour)

Change of direction

Introduction

Changes of direction have three phases:

- preparation phase
- announcement phase
- change-of-direction phase

Preparation phase

The radio/navigation system prepares you for the upcoming change of direction. The announcement is made with the words **Prepare to turn right soon..** The map can be seen in the full-screen display.

Announcement phase

The radio/navigation system announces the imminent change of direction. For example, the change of direction might be announced with the message **Turn right after four hundred metres and follow the A 81..**

Change-of-direction phase

The radio/navigation system announces the imminent change of direction. Based on the example display below, the change of direction is announced 40 metres before the change of direction with the **Please turn next right.** message.

Display and description of lane recommendations

Lane	
Recommended lane	Green
Possible lane	White
Lane not recommended	Light grey



Digital Operating Instructions

General note

Digital Operating Instructions are available for the radio/navigation system.

¹ Traffic Message Channel – radio traffic reports.

Opening the Digital Operating Instructions

- ▶ Press the ◀ or ▶ button until  (Digital Operating Instructions) is selected in the main function bar. The entry screen appears.
- ▶ Turn  the controller to select **More**.
- ▶ **To confirm your selection:** press  the controller. The display shows the submenu last used.











Example: visual search submenu











Overview of the Digital Operating Instructions







Example: radio/navigation system with Digital Operating Instructions open

- ① Navigation bar with path for the current topic
- ② Main function bar, the  main menu of the Digital Operating Instructions selected
- ③ Keypad
- ④  Controller
- ⑤  Back button
- ⑥  Delete button
- ⑦  How to use the Digital Operating Instructions
- ⑧  Article page (contents of the Operating Instructions)
- ⑨  Contents
- ⑩  Visual search
- ⑪  Keyword search

Operating the Digital Operating Instructions

- ▶ **To change the submenu:** press the  or  button.
- ▶ **To move within the Digital Operating Instructions:** turn  the controller.
- ▶ **To confirm a selection:** press  the controller.
- ▶ **To select link:** when scrolling through a text, the cursor jumps to links automatically . When the note is selected, press  the controller.
The display jumps to the relevant reference or to the relevant position on the contents page.
- ▶ **To return to the previous display:** press the  back button.
 - i** When you follow a link, the  back button only has this function if the link directs you to another reference page. If the link directs you to the contents page, you can return to the reference page by pressing the  button.
- ▶ **To expand warnings, environmental notes and damage warnings:** when scrolling through text, the cursor jumps automatically to expandable warnings, environmental notes and damage warnings. When the note is selected, press  the controller.
The appropriate warning, environmental note or damage warning expands on the same page.

- ▶ Press the  or  button to select  (quick access) in the menu of the Digital Operating Instructions.
The display shows a list of keywords for quick access to the corresponding contents of the Digital Operating Instructions.
- ▶ Turn the controller  to select a list item.
 - i** When more than seven list items appear, you can scroll through the list.
- ▶ **To confirm your selection:** press  the controller.

Calling up the help function of the Digital Operating Instructions

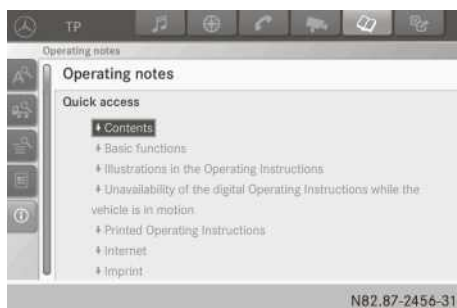

Example: quick access list

Important safety notes

WARNING

If you operate information and communication equipment integrated in the vehicle when driving, you could be distracted from the traffic situation. This could also cause you to lose control of the vehicle. There is a risk of an accident.

Only operate this equipment when the traffic situation permits. If you cannot be sure of this, stop the vehicle paying attention to road and traffic conditions and operate the equipment with the vehicle stationary.

Observe the legal requirements for the country you are in.

WARNING

If you use mobile information systems and communications devices while driving, you will be distracted from traffic conditions. You could then lose control of the vehicle. There is a risk of an accident.

Only operate these devices when the vehicle is stationary.

WARNING

If you handle or operate mobile audio/video sources while driving, your attention may be diverted from the traffic conditions. You could then lose control of the vehicle. There is a risk of an accident.

Only handle or operate these mobile audio/video sources when the vehicle is stationary. Only operate mobile audio/video sources via the communications devices integrated into the vehicle when traffic conditions permit. If this is not the case, pull over to a safe location and make entries only while the vehicle is stationary.

WARNING

If you handle a disc while driving, you may be distracted from the traffic situation. This could also cause you to lose control of the vehicle. There is a risk of an accident.

Only handle a disc when the vehicle is stationary.

Bear in mind that, at a speed of only 50 km/h your vehicle is covering a distance of nearly 14 m per second.

WARNING

SD cards are small parts. They can be swallowed and cause choking. This poses an increased risk of injury or even fatal injury.

Keep the SD card out of the reach of children. If a SD card is swallowed, seek medical attention immediately.

WARNING

Modifications to electronic components, their software as well as wiring could affect their function and/or the operation of other networked components. This could in particular also be the case for systems relevant to safety. They might not function properly anymore and/or jeopardise the operational safety of the vehicle. There is an increased risk of an accident and injury.

Do not attempt to modify the wiring as well as electronic components or their software. Always have work on electrical and electronic components carried out at a qualified specialist workshop.

WARNING

If you operate two-way radios incorrectly in the vehicle, their electromagnetic radiation can interfere with the vehicle electronics, for example if:

- the two-way radio is not connected to an exterior aerial
- the exterior aerial is not correctly mounted or is not low-reflection

This could jeopardise the operating safety of the vehicle. There is a risk of an accident.

Have the low-reflection exterior aerial fitted at a qualified specialist workshop. When operating two-way radios in the vehicle, always connect them to the low-reflection exterior aerial.

When using the device please follow:

- the safety notes in these Operating Instructions
- traffic laws and regulations
- laws pertaining to motor vehicles and safety standards

General notes

These brief instructions only describe the basic operation of your multimedia system.

All further information on the individual functions can be found on the Internet at www.mercedes-benz.de/betriebsanleitung-lkw.

Screen operation

Notes on the screen

Do not press too firmly with your fingers on the screen. This can result in a malfunction.

Moving the view

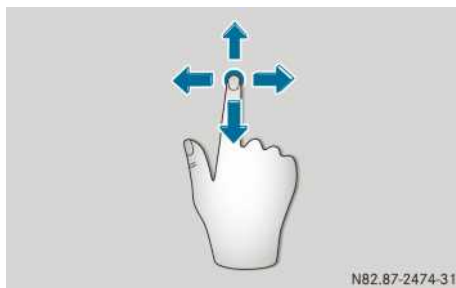

- ▶ Touch the touch-sensitive surface with one finger.
- ▶ Swipe up, down, to the left or to the right. The selection in the display moves according to the direction of the movements.

You can navigate in lists or menus in this way.

Confirming a selection

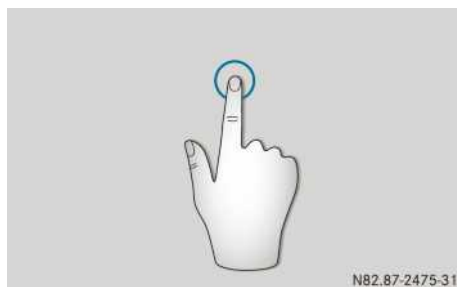

- ▶ Press the touch-sensitive surface with one finger until the point of resistance is reached. A menu item or option is selected.

Opening the menu

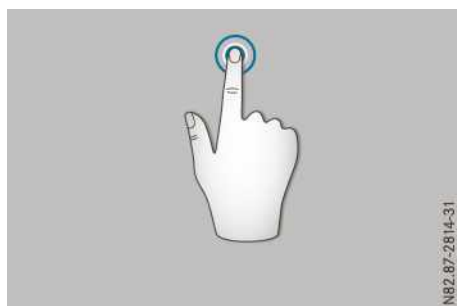

- ▶ Press and hold the touch-sensitive surface with one finger until the menu opens.

Overview

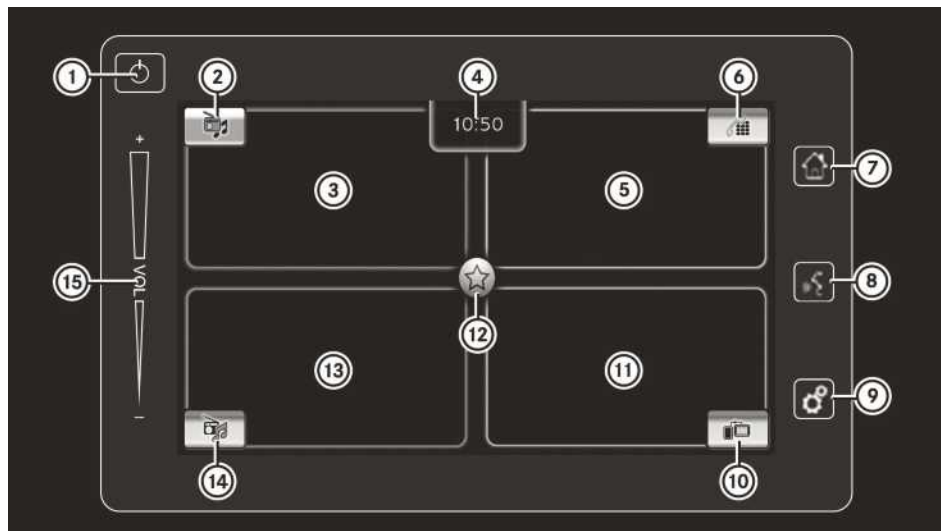

- ① To switch on and off
- ② To select a waveband
- ③ To call up the radio menu
- ④ Time
- ⑤ To call up the telephone display
- ⑥ To select/connect Bluetooth® equipment
- ⑦ To call up the homepage
- ⑧ To switch on the voice control system
- ⑨ To call up settings
- ⑩ To select an App
- ⑪ To call up MirrorLink™ or Apple CarPlay™
- ⑫ To call up favourites
- ⑬ To call up the media menu
- ⑭ To select the media source
- ⑮ To adjust the volume

Entering the PIN

- i** Keep your PIN safe. If the PIN is entered incorrectly too many times, the multimedia system is locked. The multimedia system can no longer be unlocked.

If PIN protection is activated and the multimedia system has been disconnected from the voltage supply, you will need to enter the PIN after switching on the multimedia system.

- ▶ Enter the PIN using the keypad.
- ▶ **To delete an entry:** select **[X]**.
- ▶ **To confirm the PIN:** select **OK**.

Requirements for a Bluetooth® connection

You can connect Bluetooth®-compatible mobile phones and other audio equipment to the multimedia system.

To do so, the following conditions must be met:

- mobile phones must support Hands Free Profile 1.0 or above
- the Bluetooth® device must be located inside the vehicle in the vicinity of the multimedia system
- every Bluetooth® device has a Bluetooth® name, which you can choose yourself
- Bluetooth® must be activated on both the multimedia system and on the respective Bluetooth® device
- the Bluetooth® device must be visible for the multimedia system
- the Bluetooth® device must support the audio profile A2DP

Switching Bluetooth® on/off

Bluetooth® is activated as standard and cannot be deactivated. If you select **Connect a new device**, the multimedia system will automatically become visible for other Bluetooth® devices for five minutes.

Searching for and authorising a Bluetooth® device



When using your Bluetooth® device with the multimedia system for the first time, you will need to search for the Bluetooth® device and then authorise it.

Depending on the Bluetooth® device used, a pairing code has to be entered into the Bluetooth® device or a prompt confirmed on the Bluetooth® device.

The search must be started on the Bluetooth® device.

- ▶ Select ①.
A list of Bluetooth® devices that are already authorised appears.
- ▶ Select **Add device**.
The multimedia system is visible for other Bluetooth® devices for five minutes.
- ▶ Start a search for other Bluetooth® devices on the Bluetooth® device (see the manufacturer's operating instructions).
- ▶ Select the multimedia system on the Bluetooth® device.
- ▶ Observe any possible messages on the Bluetooth® device or on the multimedia system. After the Bluetooth® device has been authorised, it is automatically connected to the multimedia system.

i You can authorise a maximum of ten Bluetooth® devices at one time. If ten Bluetooth® devices are already authorised, a Bluetooth® device must be de-authorised before a new Bluetooth® device can be authorised (> page 233).

De-authorising the Bluetooth® device



- ▶ Select ①.
A list of authorised Bluetooth® devices appears.
- ▶ Select ① beside the Bluetooth® device to be de-authorised.
A prompt appears, asking whether you really wish to de-authorise this device.
- ▶ **To not de-authorise:** select **No**.
- ▶ **To authorise:** select **Yes**.
The Bluetooth® device is de-authorised and deleted from the list of authorised Bluetooth® devices.

Telephone menu

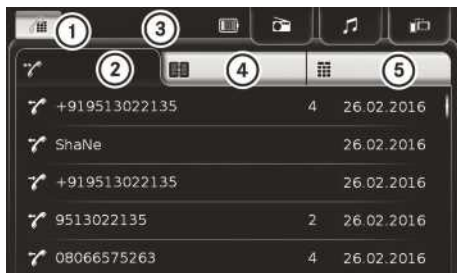

- ① To select an authorised Bluetooth® device / to connect a Bluetooth® device
- ② Call lists (dialled, accepted and missed calls)
- ③ Status line (connected mobile phone, charge status)
- ④ Contacts
- ⑤ Keypad

112 emergency call

Making emergency calls without entering a PIN is only possible directly via the mobile phone.

The **112** emergency call number is a public service. Any misuse is punishable by law.

Dialling a phone number

- ▶ Call up the telephone display.
 - ▶ Select **Dial pad**.
 - ▶ Enter the telephone number.
 - ▶ Select **Call**.
- The number is dialled.

Radio menu

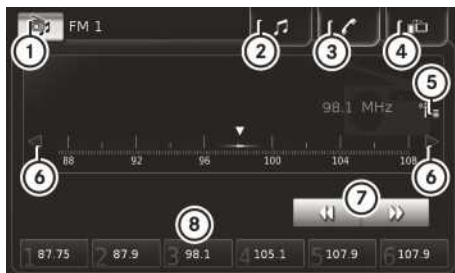

- ① To select a waveband
- ② To call up the previous media display
- ③ To call up the previous telephone display
- ④ To call up the previous Apps display
- ⑤ To call up the list of stations
- ⑥ To set the frequency manually
- ⑦ Automatic station search
- ⑧ Station presets

Setting the waveband

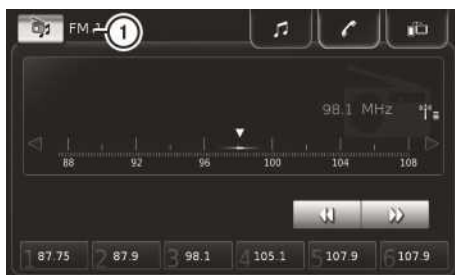

- ▶ Select ①.
- ▶ Select the desired waveband.

Setting stations using the frequency

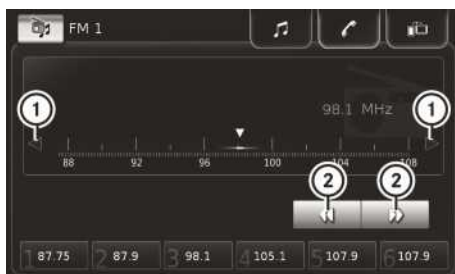

▶ Select the desired waveband (▷ page 234).

▶ **To change the frequency in increments:**
select ①.

or

▶ **To start automatic station search:**

select ②.

The next available station is played.

Storing a station

▶ Select the desired waveband (▷ page 234).

▶ Select the desired station (▷ page 234).

▶ Select desired preset position ① and press and hold.

The station is stored under the selected preset.

Media menu



- ① To select the media source
- ② Current media source
- ③ Media information (artist/track/album)
- ④ To display track list/media information
- ⑤ Remaining time
- ⑥ Next track/fast forward
- ⑦ To pause/start
- ⑧ Previous track/fast rewind
- ⑨ To activate/deactivate random playback
- ⑩ To repeat track/list/album
- ⑪ Time played

Useful information

These Operating Instructions describe all the models and standard and optional equipment of your vehicle that were available at the time of going to print. Country-specific differences are possible. Bear in mind that your vehicle may not be equipped with all the functions described. This also applies to safety-relevant systems and functions.

Read the information on qualified specialist workshops (▷ page 31).

Driving

Preparing for a journey

Visual and function check on the vehicle exterior

Before you drive off, you should carry out the following checks on the towing vehicle and the trailer/semitrailer:

- ▶ Check the vehicle for leaks.
- ▶ Make sure that the licence plate, vehicle lighting, turn signal and brake lamps are not dirty or damaged.

i The lamp check function can assist in checking the vehicle lighting:

- Vehicles with a multifunction key (▷ page 58)
 - Vehicles with the "Remote Online" function (▷ page 112)
- ▶ Check the condition of the contour markings of all attachments and add-on equipment.
 - ▶ Check wheels and tyres (▷ page 402).

Observe the following points in particular:

- general condition
- visible damage and cracks
- tyre pressures
- tyre tread depth
- wheels are seated securely

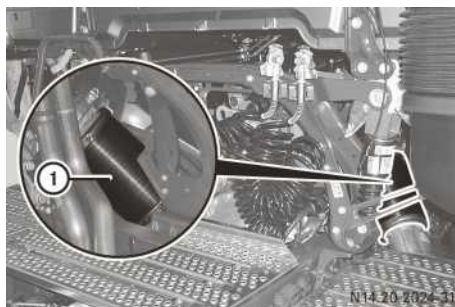

Decoupling element between the engine and exhaust pipe (example: tractor/semitrailer combination with BlueTec®6)

- ▶ Check the decoupling element of exhaust system ① for visible damage, e.g. cracks. The decoupling element is a wear part and must be checked regularly.

BlueTec®4 vehicles and BlueTec®5 vehicles: in the event of damages, the decoupling element must be replaced immediately.

BlueTec®6 vehicles: in the event of damage and/or leakage, the decoupling element must be replaced immediately. Traces of soot on the decoupling element signify leakage.

- ▶ Make sure that the vehicle is loaded correctly.
- ▶ Make sure that the side gates and exterior flaps are locked securely and not damaged.
- ▶ Fold/push in and lock folding/extendable steps before driving.
- ▶ Fold the folding underdrive guard to the road position.
- ▶ Fit and secure the mudguard centre part when operating the vehicle without a semitrailer.
- ▶ Fold down the mud flaps.
- ▶ In wintry conditions, remove snow and accumulations of ice from the tractor vehicle and trailer/semitrailer (▷ page 336).
- ▶ Make sure that cables and compressed-air lines are connected correctly (▷ page 324).
- ▶ Make sure that the semitrailer/trailer coupling is locked and secured correctly.

Observe the separate instructions issued by the manufacturer for the operation, care and maintenance of the semitrailer/trailer coupling.

Have all faults and damage rectified. If necessary, have the causes determined and rectified at a qualified specialist workshop.

Visual and function check in the vehicle

General notes

Please note that all electronic systems in the vehicle only serve to assist you. They do not relieve you of the obligation to carry out a visual inspection of the vehicle and the trailer/semi-trailer before starting a journey.

Activating driving systems

Before driving on public roads:

- ▶ Activate Stability Control Assist (▷ page 267) or activate ASR (▷ page 266).
- ▶ Vehicles with level control: set the driving level (▷ page 298).



Checking the emergency equipment/ first-aid kit

You will find an overview of emergency equipment and first-aid kits in the "Breakdown assistance" section (▷ page 369).

- ▶ Check the emergency equipment to make sure that it is accessible, complete and ready for use, for example:
 - reflective safety vest
 - warning triangle
 - warning beacon
 - first-aid kit
 - fire extinguisher
- ▶ At regular intervals, check that the first-aid kit is usable. Note the use-by dates of the contents.
- ▶ Have the fire extinguisher checked every one to two years.
- ▶ The fire extinguisher must be refilled after each use.

When carrying emergency equipment, e.g. a breathalyser, observe the legal requirements of the country in which you are currently driving.

Checking the vehicle lighting, turn signal lamps and brake lamps

- ▶ Switch the ignition lock to the drive position. If a bulb on the towing vehicle is faulty, the on-board computer displays a corresponding event window. In the case of a bulb failure, the event window displays  and  for the towing vehicle.
- ▶ Check the vehicle lighting, turn signal lamps and brake lamps on the tractor vehicle and

trailer/semi-trailer with the help of a second person.

or

- ▶ Check the vehicle lighting using the multi-function key (▷ page 58).

or

- ▶ Check vehicle lighting using the Truck-App (▷ page 112).
- ▶ Replace faulty bulbs (▷ page 91).

Checking the fuel/AdBlue® supply

- ▶ Check the fuel level/AdBlue® level shown on the fuel gauge (▷ page 129) and on the AdBlue® gauge (▷ page 129).
- ▶ If necessary, refuel (▷ page 315) and top up the AdBlue® (▷ page 318).

Checking the engine oil level

Check the engine oil level before the start of every journey (▷ page 148). The engine oil level is not displayed while driving.

Ignition lock

Important safety notes

WARNING

If you switch off the ignition while the vehicle is in motion, safety-relevant functions are restricted or not available. This can affect the power steering function and the brake boosting effect, for example. You will then require considerably more force to steer and brake. There is a risk of an accident.

Do not switch off the ignition while the vehicle is in motion.

WARNING

If you leave children unattended in the vehicle, they could set the vehicle in motion by, for example:

- releasing the parking brake
- shifting the transmission into neutral
- starting the engine

They could also operate the vehicle's equipment and become trapped. There is a risk of an accident and injury.

When leaving the vehicle, always take the key with you and lock the vehicle. Never leave children unattended in the vehicle.

⚠ WARNING

If you attach heavy or large objects to the key, the key could be unintentionally turned in the ignition lock. This could cause the engine to be switched off. There is a risk of an accident.

Do not attach any heavy or large objects to the key. Remove any bulky keyrings before inserting the key into the ignition lock.

Key positions of the mechanical ignition lock

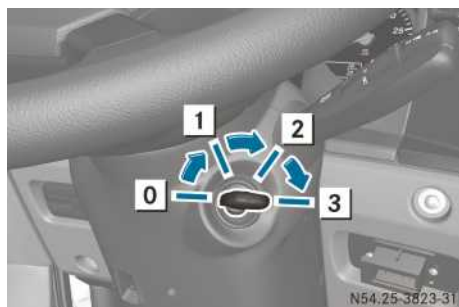

Ignition lock on the steering column

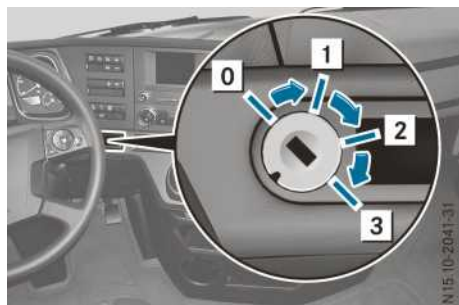

Ignition lock on the dashboard

- 0 To insert/remove the vehicle key
- 1 Steering wheel unlocked/radio position
- 2 Drive position
- 3 Start position

Vehicles with the ignition lock on the steering column: when you remove the key in position 0, the steering is locked.

Switch positions of the electronic ignition lock

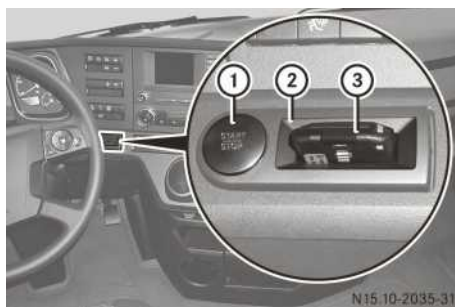

Example: ignition lock

The ignition lock consists of key slot ②, which receives key ③, and Start/Stop button ①, which has two positions. To activate the ignition lock, insert key ③ into key slot ② as far as it will go. Insert key ③ into the key slot with the Mercedes star facing upwards.

- ① The multifunction key is secured against turning. The multifunction key can only be inserted into the key slot in one position.
- ② The key may heat up in the key slot.

The ignition lock has the following switch positions:

- 0
 - Insert key ③.
 - The ignition and the display of the instrument cluster are off.
- 1 – radio position
 - Power supply for some consumers.
 - The display of the instrument cluster shows the greeting display (Mercedes star). After a short time the display also shows the date and time.
- 2 – drive position
 - The ignition is switched on.
 - The instrument cluster display shows a menu window or an event window.
- 3 – start position

When key ③ is inserted and Start/Stop button ①:

- is pushed in all the way, the ignition lock is switched to position **3** and the engine starts
- is pushed in to the first switching threshold, the ignition lock is switched to the next position, **0**, **1** or **2**

If you press the Start/Stop button when in position **2**, the ignition lock switches back to position **0**.

You can switch the engine off when the vehicle is stationary by:

- pressing Start/Stop button ① as far as it will go
The ignition lock is then in position **1**.
- pressing Start/Stop button ① to the first switching threshold and then release
The ignition lock is then in position **1**.
- removing key ③ from the ignition lock
The ignition lock is then in position **0**.

Ignition run-on

The ignition run-on function is only available in combination with an electronic ignition lock.

The ignition run-on function allows you to leave the ignition switched on and pull out key ③ from the ignition lock. This means you can leave and lock the cab when the ignition is switched on or use additional functions of the multifunction key. The ignition run-on function is limited to a duration of a maximum of 60 minutes. Then the ignition lock switches to position **0** and switches off the ignition.

- ▶ Push Start/Stop button ① in to the first switching threshold and hold.
- ▶ Remove the key.
The on-board computer shows the **Ignition, delayed switch-off active** event window.

i Only release Start/Stop button ① once you have completely removed the key.

- ▶ Release Start/Stop button ①.
The ignition lock stays in position **2**.

If you re-insert the key in the key slot, the ignition run-on function is deactivated again.

Engine run-on

WARNING

When using the engine run-on function, the vehicle may start to roll if crawler mode is activated and the pulling-away gear is engaged. There is a risk of an accident.

When using the engine run-on function:

- shift the transmission into neutral.
- apply the parking brake.

The engine run-on function is only available in combination with an electronic ignition lock.

The engine run-on function allows you to leave the engine running while stationary and pull out key ③ from the ignition lock. This means, for example, that you can lock the cab and use power take-off or level control in working mode.

- ▶ Stop the vehicle.
- ▶ Press Start/Stop button ① in to the first switching threshold and hold.
- ▶ Remove the key.
The on-board computer shows **Shunting speed only** in the event window.

i Only release Start/Stop button ① once you have completely removed the key.

- ▶ Release Start/Stop button ①.
The ignition lock remains in position **2** and the engine is left running.

The vehicle speed is limited to approximately 6 km/h while the engine run-on function is active.

If you re-insert the key in the key slot, the engine run-on function is deactivated again.

Before driving off

Important safety notes

WARNING

If objects, luggage or loads are not secured or not secured sufficiently, they could slip, tip over or be flung around and thereby hit vehicle occupants. There is a risk of injury, especially when braking or abruptly changing directions.

Always store objects so that they cannot be flung around. Secure objects, luggage or

loads against slipping or tipping before the journey.

WARNING

Objects in the driver's footwell can impede pedal travel or block a pedal which is depressed. This jeopardises safe operation of the vehicle. There is a risk of an accident.

Stow all objects in the vehicle safely, so that they cannot reach the driver's footwell. Make sure the floor mats and carpets are properly secured so that they cannot slip and obstruct the pedals. Do not lay several floor mats or carpets on top of one another.

WARNING

If you load the vehicle unevenly, driving characteristics such as steering and braking behaviour may be severely impaired. There is a risk of an accident.

Load the vehicle evenly. Secure the load so that it cannot slip.

The vehicle's driving, braking and steering characteristics vary with the type, weight and centre of gravity of the load.

- ▶ Close all doors.
- ▶ Make sure that the floor mats and carpets are properly secured so that they cannot slip and obstruct the pedals.

Starting the engine

WARNING

Combustion engines emit poisonous exhaust gases such as carbon monoxide. Inhaling these exhaust gases leads to poisoning. There is a risk of fatal injury. Therefore never leave the engine running in enclosed spaces without sufficient ventilation.

! When the engine oil pressure is too low, the on-board computer displays the  symbol in the red event window. A warning tone also sounds.

The operating safety of the engine is jeopardised. Switch off the engine immediately.

Observe the information and instructions on this event window in the "On-board computer and displays" section (▷ page 178).

- ▶ Depress the brake pedal or apply the parking brake.
- ▶ Switch the ignition lock to the drive position. The display check for the instrument cluster starts. The display check in the instrument cluster allows you to see what equipment is present and whether there are any faults with their functions.

The immobiliser is deactivated and the engine can be started. If you use an invalid key, the on-board computer will show an event window. Use a valid spare key.

Vehicles with Mercedes PowerShift: the on-board computer displays the transmission-shift position and the automatic drive program **A**, **A economy**, **A power**, **A offroad**, **A fleet** or **A fire-sv**.

- ▶ Check the engine oil level (▷ page 148).
- ▶ Shift into neutral.
- ▶ Disengage power take-off (▷ page 343).
- ▶ Deactivate the loading tailgate; see the separate Operating Instructions.
- ▶ Vehicles with engine preheating: at outside temperatures below -20 °C, preheat the engine before starting (▷ page 125).
- ▶ Press and hold the Start/Stop button as far as it will go, or turn the key to the start position in the ignition lock. Do not depress the accelerator pedal whilst doing so.
- ▶ Once the engine starts normally, release the Start/Stop button or the key. The idling speed is controlled automatically.

i The engine idling speed is raised at very low outside temperatures or during regeneration of the diesel particle filter.

- i** The starting procedure is automatically cancelled:
 - after approximately 60 seconds on vehicles with the OM 936 engine
 - after approximately 40 seconds on vehicles with the OM 470, OM 471 or OM 473 engine

In vehicles with the OM 460 engine you must interrupt the starting procedure after 20 seconds and repeat after approximately one minute. After three starting procedures wait for approximately three minutes.

- ▶ If the engine fails to start: rectify the cause of the poor starting characteristics.

Possible causes of poor starting characteristics are, for example:

- a blocked fuel filter
- an empty fuel tank (▷ page 315)
- fuel system not bled (▷ page 376)
- ▶ Repeat the starting procedure.
- ▶ If the engine still fails to start, contact a qualified specialist workshop.

Safety inspection

Checking the reservoir pressure in the compressed-air brake system

WARNING

It is not possible to brake the vehicle if the compressed-air brake system has a leak or if there is insufficient reservoir pressure. There is a risk of an accident.

Do not pull away until the required reservoir pressures have been reached.

In the event of loss of pressure while driving, immediately bring the vehicle to a halt in accordance with the traffic conditions.

Secure the vehicle using the parking brake. Have the compressed-air system repaired at a qualified specialist workshop.

- ▶ Start the engine.
- ▶ Leave the engine running until the  warning lamp in the instrument cluster goes out. For vehicles without BlueTec[®] exhaust gas after treatment, the reservoir pressure display of the brake circuit in the instrument cluster shows at least 11 bar.
- ▶ For BlueTec[®] vehicles, call up the **Reserve pressure** menu window (▷ page 148) and check the current reserve pressure.

Observe the event window in the on-board computer and the indicator lamps in the status area of the on-board computer/instrument cluster for the reservoir pressure and the compressed-air brake system.

Checking the reservoir pressure in the transmission/clutch circuit

WARNING

If there is a loss of pressure or insufficient reservoir pressure in the transmission/clutch circuit, you can no longer shift gears. There is a risk of an accident.

Do not pull away, or stop the vehicle as soon as possible, paying attention to road and traffic conditions. Secure the vehicle against rolling away, e.g. with the parking brake. Have the compressed-air system repaired at a qualified specialist workshop.

The reservoir pressure in the transmission/clutch circuit is supplied once brake circuits 1 and 2 have been charged.

If the reservoir pressure in the transmission/clutch circuit is too low, the on-board computer will display the yellow  **Transmission/clutch reserve pressure too low** event window.

- ▶ Start the engine.
- ▶ Leave the engine running until the yellow  **Transmission/clutch reserve pressure too low** event window in the on-board computer goes out.

Checking the function of the compressed-air dryer

WARNING

If the condensation level in the compressed-air reservoir is too high, the braking effect may reduce or the brake system may fail. There is a risk of an accident.

Check the compressed-air system for condensation before starting a journey. If the condensation level is high, have the compressed-air brake system checked at a qualified specialist workshop immediately.

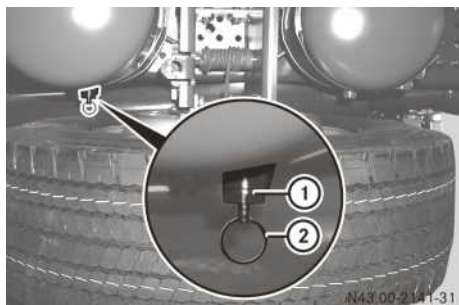

Release valve on the compressed-air reservoir

- ▶ Start the engine.
- ▶ Check the reservoir pressure in the compressed-air brake system.
- ▶ If the on-board computer displays the red **Brake supply pressure in circuit 1 too low** and/or **Brake supply pressure in circuit 2 too low** event window, leave the engine running until the red event window goes out.
The compressed-air system is charged.
- ▶ Switch off the engine.
- ▶ Pull ring ② on drain plug ① and drain off the condensation.
- ▶ If a large amount of condensation runs out, have the compressed-air brake system checked at a qualified specialist workshop.

Vehicles with condensation monitoring:

- ▶ If the system detects that the number of regeneration phases performed is insufficient, the yellow  **Condensation in compressed-air reservoir** event window is displayed in the on-board computer.

Checking the vehicle height

Vehicles with level control: when driving with a lowered or raised chassis, the driving and braking characteristics may be affected. Additionally, the maximum permitted vehicle height may be exceeded when the chassis is raised. Observe the legally permissible vehicle heights for the country you are currently in.

If the yellow  indicator lamp lights up in the instrument cluster, the chassis is not at driving level.

- ▶ Set the driving level (▷ page 298).
The  indicator lamp in the instrument cluster goes out.

Pulling away

- ⚠ Do not pull away as soon as the engine starts. Let the engine run in neutral for a short time after starting, until there is sufficient engine oil pressure. Do not drive at high engine speeds when the engine is cold.
This will prevent excessive wear and possible engine failure.

- ⚠ Do not hold the steering wheel for longer than 10 seconds with the steering at full lock. Otherwise, the power steering assistance could malfunction.

Do not turn the steering wheel forcefully if the wheels are resting on the curb or other similar surfaces. Otherwise, the power steering assistance could be damaged.

You should pay special attention to road conditions when temperatures are around the freezing point.

There is a delay in displaying a change in outside temperature.

If the brake system is defective, braking behaviour may change or the brake system may fail. If you notice a reduction in braking power when testing the brakes, stop the vehicle as soon as possible while paying attention to traffic conditions. Have the brake system checked and repaired at a qualified specialist workshop.

Always pay attention to the information in the event window, which is shown by the on-board computer if the brake system is malfunctioning. In addition, an indicator lamp lights up in the instrument cluster or the status area of the on-board computer and a warning tone may sound. Braking behaviour may change. The pedal travel and pedal force required to brake the vehicle may increase.

If you ignore warning lamps and messages in the display, you will not recognise failures and faults affecting the brake system components and systems. Braking behaviour may change. The pedal travel and pedal force required to brake the vehicle may increase. Have the brake system checked and repaired at a qualified specialist workshop. Always pay attention to the warning lamps and messages in the display.

Vehicles with an automated manual transmission and without a hydrodynamic clutch: the vehicle has a selectable crawler mode. When crawler mode is activated, the vehicle crawls automatically when the service brake is released and continues rolling at the engine

idling speed. You can find information on crawler mode in the "Automated manual transmission" section (▷ page 257).

Vehicles with a hydrodynamic clutch: always pay attention to the information about pulling away in the section "Hydrodynamic clutch" (▷ page 264).

When the vehicle is stationary and the transmission is in neutral, the engine has delayed throttle response.

- ▶ Engage a gear, see "Automated manual transmission" (▷ page 253) or "Manual transmission" (▷ page 251).
- ▶ Release the brake pedal or parking brake and slowly depress the accelerator pedal.
- ▶ If the drive wheels spin when pulling away, switch on the starting-off aid (▷ page 300).
- ▶ When starting a journey, carry out a brake test. Observe the road and traffic conditions when doing so.

Warm up the engine quickly by driving at moderate engine speeds. After approximately 10 to 20 minutes, the engine will reach its operating temperature of between approximately 85 and 100 °C, depending on the outside temperature.

You can utilise the full engine power output once the engine has reached normal operating temperature.

Stopping and switching off the engine

WARNING

Flammable material such as leaves, grass or twigs may ignite if they come into contact with hot parts of the exhaust system or exhaust gas flow. There is a risk of fire.

Park the vehicle so that no flammable material can come into contact with hot vehicle components. In particular, do not park on dry grassland or harvested grain fields.

WARNING

The parking brake may not be sufficient to secure the vehicle on uphill and downhill gradients. A loaded vehicle or a vehicle with trailer/semitrailer may roll away. There is a risk of an accident.

In the control position, check whether the parking brake alone can hold the entire vehicle. The tractor unit and trailer/semitrailer should normally be secured using the parking brake and wheel chocks.

WARNING

If you switch off the ignition while the vehicle is in motion, safety-relevant functions are restricted or not available. This can affect the power steering function and the brake boosting effect, for example. You will then require considerably more force to steer and brake. There is a risk of an accident.

Do not switch off the ignition while the vehicle is in motion.

WARNING

If you leave children unattended in the vehicle, they could set the vehicle in motion by, for example:

- releasing the parking brake
- shifting the transmission into neutral
- starting the engine

They could also operate the vehicle's equipment and become trapped. There is a risk of an accident and injury.

When leaving the vehicle, always take the key with you and lock the vehicle. Never leave children unattended in the vehicle.

Ensure that you observe the safety notes in the "Children in the vehicle" section (▷ page 54).

You can find information on crawler mode in the "Automated transmission" section (▷ page 257).

Vehicles with automated manual transmission: after stopping the vehicle with crawler mode activated, the vehicle begins to crawl again if you:

- do not shift the transmission into neutral
- do not apply the parking brake
- release the service brake again
- ▶ Stop the vehicle.
- ▶ Apply the parking brake.
- ▶ Shift to neutral.

Let the engine idle for approximately 2 minutes before switching it off, if:

- the vehicle has been driven for a prolonged period with the hydrodynamic clutch in operation
- the vehicle has been driven for a prolonged period in retarder mode
- the coolant temperature is above approximately 100 °C
- full engine power has been used, e.g. while driving in mountainous terrain or during combined operation

▶ **To switch off the engine:** press the Start/Stop button to the first switch threshold and then release it.

or

▶ Press the Start/Stop button as far as it will go.

or

▶ Turn the key back in the ignition lock as far as it will go.

▶ Safeguard the vehicle against rolling away; use chocks if necessary.

Brakes

Brake system

If the brake system is defective, braking behaviour may change or the brake system may fail. If you notice a reduction in braking power when testing the brakes, stop the vehicle as soon as possible while paying attention to traffic conditions. Have the brake system checked and repaired by a qualified specialist workshop.

Always pay attention to the information in the yellow (> page 167) or red (> page 182) event windows, which are shown by the on-board computer if the brake system is malfunctioning. In addition, an indicator lamp lights up in the instrument cluster or the status area of the on-board computer and a warning tone may sound. Braking behaviour may change. The pedal travel and pedal force required to brake the vehicle may increase. Have the brake system checked and repaired by a qualified specialist workshop. The vehicle is equipped with an electronic braking system (EBS) when it leaves the factory and can include the following functions:

- ABS (Anti-lock Braking System)
- ASR (acceleration skid control system)
- ALB (automatic load-dependent brake)

- Hill holder
- BAS (Brake Assist)

The electronic control is able to relieve the load on the service brake by activating the continuous brake, depending on the vehicle load and the weather conditions.

The control system harmonises the braking processes of the tractor vehicle and the trailer/ semitrailer to ensure braking of the entire tractor/trailer combination, continuously balancing the braking force at individual wheels according to weight distribution. This means the vehicle and trailer combination has improved braking characteristics. On vehicles with disc brakes on all axles, the electronic control system monitors the temperature of the disc brakes.

If the electronic control detects malfunctions, a corresponding event window appears in the on-board computer.

If you brake hard (emergency braking) from a speed greater than approximately 50 km/h, the hazard warning lamps are switched on automatically. The hazard warning lamps flash at a higher frequency.

The hazard warning lamps are switched off automatically if:

- emergency braking is interrupted or
- the vehicle comes to a standstill after the emergency braking and then pulls away again

i If the vehicle comes to a standstill after emergency braking, the hazard warning lamps continue to flash at the normal frequency.

Checking the compressed-air brake system for leaks

WARNING

It is not possible to brake the vehicle if the compressed-air brake system has a leak or if there is insufficient reservoir pressure. There is a risk of an accident.

Do not pull away until the required reservoir pressures have been reached.

In the event of loss of pressure while driving, immediately bring the vehicle to a halt in accordance with the traffic conditions.

Secure the vehicle using the parking brake.

Have the compressed-air system repaired at a qualified specialist workshop.

Do not let anyone enter or exit the vehicle during the test. This avoids you mistaking pressure loss from the air-sprung seats or the level control system for a leak.

- ▶ Stop the vehicle on a level surface.
- ▶ Apply the parking brake.
- ▶ Use chocks to safeguard the vehicle against rolling away.
- ▶ Release the parking brake.
- ▶ Switch the ignition lock to the drive position.
- ▶ Call up the **Reserve pressure** menu window in the on-board computer in the  Monitoring info menu (▷ page 148).
- ▶ Run the engine until the display shows a reservoir pressure of at least 11 bar.
- ▶ Switch off the engine.
- ▶ Switch the ignition lock to the drive position.
- ▶ Call up the **Reserve pressure** menu window in the on-board computer again.
- ▶ Depress the brake pedal and keep it in this position.
- ▶ Read off the reservoir pressure after approximately 1 minute.
- ▶ Read off the reservoir pressure again after another minute.

If no significant loss of pressure can be detected in the **Reserve pressure** menu window in the on-board computer after this minute, the compressed-air brake system is free from leaks.

If a significant loss of pressure is detected, the compressed-air brake system is leaking.

- ▶ If the compressed-air brake system is leaking, have it checked and repaired by a qualified specialist workshop.

ABS (Anti-lock Braking System)

General notes

ABS controls the braking pressure so that the wheels do not lock under braking. This means that the vehicle can still be steered while braking.

ABS is operational from walking pace, regardless of road surface conditions. If the road is

slippery, ABS intervenes even if you only brake gently.

- ▶ **Vehicles with engaging four-wheel drive (VG 3000):** always deactivate ABS when driving off-road.





ABS display check

WARNING

If ABS is malfunctioning, the wheels could lock when braking. The steerability and braking characteristics are thus severely impaired. There is an increased risk of skidding and an accident.

Drive on carefully. Have the ABS checked at a qualified specialist workshop as soon as possible.

The anti-lock protection function is not guaranteed if, after the ignition is switched on:

- no brake system display appears in the status area of the on-board computer or
- the display does not go out after 3 seconds or
- the display does not go out when the vehicle pulls away
- ▶ Switch the ignition lock to the drive position. The  indicator lamp for ABS equipment is shown in grey in the status area of the on-board computer for approximately 3 seconds. The  indicator lamp is supplemented by the ,  or  indicator lamps for towing vehicles and/or trailers/semitrailers.

If the electronic control detects ABS faults, a corresponding event window appears in the on-board computer. A coloured indicator lamp for the affected ABS equipment also lights up in the status area of the on-board computer as described above.

Braking with anti-lock protection

WARNING

The wheels of the trailer/semitrailer may lock when braking and the vehicle combination may become unstable if:

- the trailer/semitrailer does not have ABS
- the ABS of the trailer/semitrailer has failed
- ABS has failed completely

As a result, you could lose control of the vehicle and cause an accident.

Always adapt your driving style to the prevailing road and weather conditions and maintain a sufficient, safe distance from other road users. Avoid full brake applications; except in emergency situations.

- i** Even if Stability Control Assist is activated you can still block the wheels of the trailer/semitrailer when braking.

Anti-lock protection improves the directional stability and the steerability of the vehicle or tractor/trailer combination during braking.

If you fail to adapt your driving style or if you are inattentive, the driving safety systems can neither reduce the risk of an accident nor override the laws of physics. Driving safety systems are merely aids designed to assist driving. You are responsible for the distance to the vehicle in front, for vehicle speed and for braking in good time. Always adapt your driving style to the prevailing road and weather conditions and maintain a sufficient, safe distance from other road users. Drive carefully.

If ABS is deactivated or if there is a malfunction in the vehicle's brake system, Active Brake Assist is automatically deactivated.

When ABS is intervening:

- ▶ Continue to depress the brake pedal until the braking situation is over.
When ABS is intervening, the continuous brake is switched off. The  indicator lamp in the instrument cluster remains on.

During a full brake application:

- ▶ Depress the brake pedal with force.

If you want to drive the tractor vehicle with a trailer/semitrailer with ABS or an electronic brake system:

- ▶ Connect a control cable to the socket or to the ABS plug (▷ page 324).

If you want to drive the semitrailer tractor vehicle without a trailer or with a trailer without ABS:

- ▶ Insert the control cable into the blank socket.

Deactivating/activating ABS



WARNING

If ABS is deactivated, the wheels may lock when braked. As a result, the vehicle can no longer be steered. There is an increased risk of skidding and an accident.

Always leave ABS on when driving on roads and firm surfaces.



ABS is automatically activated when you start the engine. By deactivating ABS, it may be possible to achieve shorter braking distances on rough terrain and on unpaved roads, e.g. on soft ground. You can only deactivate ABS for the tractor vehicle.

- ▶ Press the upper section of the  button.
When the  indicator lamp in the instrument cluster lights up, ABS is deactivated.

BAS (Brake Assist System)

WARNING

If BAS is malfunctioning, the braking distance in an emergency braking situation is increased. There is a risk of accident.

In an emergency braking situation, depress the brake pedal with full force. ABS prevents the wheels from locking.

BAS operates in emergency braking situations. If you depress the brake pedal quickly, BAS boosts the braking force and thus shortens the braking distance.

Braking using BAS:

- Keep the brake pedal firmly depressed until the emergency braking situation has passed. ABS prevents the wheels from locking when this occurs.

The brakes will function as usual once you release the brake pedal. BAS is deactivated.

Independent trailer brake

⚠ WARNING

If the independent trailer brake is used incorrectly, e.g. as a substitute for the continuous brake, the trailer/semitrailer brake may over-heat or lock. The vehicle is then no longer safe or roadworthy. There is a risk of an accident.

Only use the independent trailer brake for short-term adaptive braking.



Independent trailer brake lever (example: Actros GigaSpace)

The independent trailer brake can be used independently of the service and parking brake of the towing vehicle.

The independent trailer brake only brakes the wheels on the trailer/semitrailer.

The independent trailer brake can be used to perform adaptive braking on downhill gradients. This prevents the tractor/trailer combination from jack-knifing.

If the independent trailer brake is not sufficient, reduce speed with the service brake or the continuous brake.

- **To brake/straighten the tractor/trailer combination:** pull the independent trailer brake lever to fully applied position **2** until the required braking effect of the trailer/

semitrailer is achieved. Hold the lever in this position.

- **To release the independent trailer brake:** let go of the independent trailer brake lever. The independent trailer brake lever returns to release position **1**.

Parking brake

⚠ WARNING

If the parking brake lever is not in the fully applied position, it automatically returns to the released position. The vehicle could roll away as a result. There is a risk of an accident. Move the lever into the fully applied position when parking the vehicle.

⚠ WARNING

The parking brake may not be sufficient to secure the vehicle on uphill and downhill gradients. A loaded vehicle or a vehicle with trailer/semitrailer may roll away. There is a risk of an accident.

In the control position, check whether the parking brake alone can hold the entire vehicle. The tractor unit and trailer/semitrailer should normally be secured using the parking brake and wheel chocks.

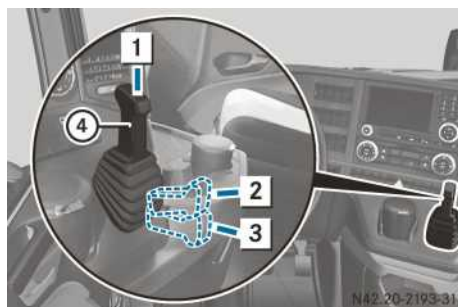

Parking brake lever (example: Actros GigaSpace)

Safeguard the parked vehicle against rolling away by applying the parking brake. The parking brake actuates the spring-loaded parking brake cylinder.

For fire engines, the parking brake can also influence the service brake of the front axle. This option is intended for the safe restraint of the

vehicle, e.g. when carrying out rescue operations using the winch.

You can find further information about the parking brake on the trailer/semitrailer in the manufacturer's operating instructions.

Applying the parking brake

- ▶ Move parking brake lever ④ from release position 1 to fully applied position 2, push it downwards and engage it. If you cannot move the parking brake lever further, then it is engaged and the parking brake has been applied.

The red (P) indicator lamp in the instrument cluster lights up.

Trailer/semitrailer with EC brake system: when the trailer/semitrailer is attached, the parking brake acts on the service brake of the trailer/semitrailer.

In vehicles with four air-sprung axles, the trailing axle lowers automatically when you apply the parking brake. As a result, braking performance is increased. As the vehicle briefly lowers, the yellow (P) indicator lamp flashes in the instrument cluster. If the trailing axle has not lowered, the yellow (P) indicator lamp flashes continuously when the ignition has been switched on. After the key has been removed from the ignition, the yellow (P) indicator lamp flashes for another ten minutes and then goes out.

If the trailing axle has not lowered, secure the vehicle in particular against rolling away. Have the trailing axle checked immediately at a qualified specialist workshop.

Testing the parking brake

- ▶ Apply the parking brake.
- ▶ Press the top of parking brake lever ④. While doing so, move parking brake lever ④ beyond fully applied position 2 into control position 3 and hold it. During the test, the vehicle combination is only held by the force exerted by the spring-loaded brake of the tractor vehicle. The trailer/semitrailer brake is released. The vehicle must not move.
- ▶ If the force exerted by the spring-loaded brake cannot hold the vehicle combination,

secure the tractor vehicle and trailer/semitrailer with chocks.

- ▶ Move parking brake lever ④ from control position 3 back to fully applied position 2 and engage it.

Releasing the parking brake

- ▶ Pull parking brake lever ④ upwards from fully applied position 2 and swing it up into released position 1 as far as it will go. The red (P) indicator lamp in the instrument cluster goes out.

If the red (P) indicator lamp in the instrument cluster does not go out, the spring-loaded brake circuit charge pressure is too low.

To tow the vehicle, you can also manually release the spring-loaded parking brake cylinder on the parking brake (▷ page 400).

Frequent-stop brake

WARNING

When securing the vehicle against rolling away with the frequent-stop brake, the braking pressure may be too low. The vehicle could roll away even though the frequent-stop brake is engaged. There is a risk of an accident.

Never leave the driver's seat with the frequent-stop brake activated and be prepared to apply the brakes. If the vehicle begins to roll, apply the service brake.

WARNING

If you brake in wintry road conditions while the frequent-stop brake is activated, the wheels may lock shortly before stopping. Even if you take your foot off the brake pedal, the wheels remain locked. The vehicle may skid or slip away, e.g. on uphill or downhill gradients. There is a risk of an accident.

Never activate the frequent-stop brake in wintry conditions.

WARNING

If you do not stop the vehicle using the service brake, e.g. when rolling to a stop, the frequent-stop brake will not be activated. The



vehicle could roll away. There is a risk of an accident.

Always brake the vehicle to a standstill using the service brake in order to activate the frequent-stop brake.



The frequent-stop brake uses less compressed air than the parking brake. Use the frequent-stop brake if you frequently pull away and stop for short periods of time, e.g. in refuse collection operation. The frequent-stop brake does not replace the service brake or the parking brake. Further information on parking the vehicle can be found in the "Stopping and parking" section (▷ page 243).

If the ignition lock is switched to position 0 while the frequent-stop brake is activated, the frequent-stop brake remains activated. An event window is shown in the on-board computer and a warning tone sounds.

► **To activate:** press the lower section of the  switch.
The  indicator lamp in the status area of the on-board computer lights up.

► **To deactivate:** press the upper section of the  switch.

or

► Press the  /  switch into the central position.
The  indicator lamp in the status area of the on-board computer goes out.

Vehicles with automatic manual transmission: when you activate the frequent-stop brake, crawler mode is deactivated automatically. You can find information on crawler mode in the "Automated transmission" section (▷ page 257).

Hill holder

WARNING

If you brake in wintry road conditions with the hill holder activated, the wheels can lock shortly before stopping. Even if you take your foot off the brake pedal, the wheels remain locked. The vehicle may skid or slip away, e.g. on uphill or downhill gradients. There is a risk of an accident.

Never activate the hill holder in wintry conditions.

WARNING

If you do not stop the vehicle using the service brake, e.g. when coasting to a stop, the hill holder will not be activated. The vehicle could roll away. There is a risk of an accident.

Always brake the vehicle to a standstill using the service brake in order to activate the hill holder.





The hill holder assists you when driving on uphill or downhill gradients. The hill holder prevents the vehicle from rolling and facilitates controlled pulling away.

► **To activate:** press the upper section of the  switch.

► **To deactivate:** press the lower section of the  switch.

Vehicles with automated manual transmission: if you do not depress the brake pedal while the vehicle is stationary and the hill holder is active, a warning tone sounds. The hill holder is deactivated and the  indicator lamp in the instrument cluster goes out.

Vehicles with manual transmission: if you do not depress the accelerator, clutch or brake pedal while the vehicle is stationary and the hill holder is active, a warning tone sounds. The hill holder is deactivated and the  indicator lamp in the instrument cluster goes out.

When your vehicle's brake pedal is depressed until the vehicle is stationary while the hill holder is activated, the hill holder is active and the  indicator lamp in the instrument cluster lights up.

If you then apply the parking brake, the hill holder is deactivated and the  indicator lamp in the instrument cluster goes out. The vehicle is then held by the parking brake. After the parking brake is released, the hill holder is no longer active. If you depress the brake pedal, the hill holder remains active after the parking brake is released.

If you depress the accelerator pedal and the vehicle pulls away, the hill holder is released automatically. The  indicator lamp in the instrument cluster goes out.

The hill holder remains activated in forward and reverse gear even after a brief stop or after the engine is switched off.

Vehicles with automated manual transmission: if crawler mode is active, the hill holder is automatically released when the vehicle begins to creep forward after the service brake has been released.

Crawler mode is cancelled automatically when its functional limits are reached (> page 257). The on-board computer then displays the **Crawler mode cancelled** event window. A warning tone sounds and the transmission control disengages the clutch. In this case, depress the brake pedal to bring the vehicle to a halt or depress the accelerator pedal to pull away again.

Continuous brake

Important safety notes

WARNING

If you activate the continuous brake or shift to a lower gear on a slippery road surface in order to increase the engine's braking effect, the drive wheels may lose traction. There is an increased risk of skidding and an accident.

Do not activate the continuous brake and do not shift to a lower gear in order to increase the engine's braking effect on a slippery road surface.

WARNING

If there is a retarder or retarder control malfunction, braking characteristics can change. The vehicle can brake uncontrollably. The wheels can block and thus lose traction on slippery road surfaces. This can cause the vehicle to skid. There is a risk of an accident. Drive with even greater care or stop the vehicle immediately in accordance with the traffic conditions. Have the retarder checked and repaired immediately at a qualified specialist workshop.

Always observe the warning lamps and display messages and follow the described measures.

The engine brake and retarder are used as a continuous brake.



You can utilise the engine's braking effect, particularly on long downhill gradients if you:

- activate the continuous brake
- shift to a lower gear in good time

The continuous brake is activated automatically if:

- after several brake applications, the vehicle electronics detect that the vehicle is loaded and you then depress the brake pedal
- cruise control, speed limiter or distance control assistant intervene in overrun mode

Activating/deactivating the continuous brake

 If the continuous brake is deactivated and the  indicator lamp in the instrument cluster does not go out, have the continuous brake checked at a qualified specialist workshop.



Example: multifunction lever

BlueTec® vehicles without a retarder are equipped with three brake levels (1 - 3) and vehicles without BlueTec® exhaust gas aftertreatment with two brake levels (1 - 2).

If the ignition lock is switched to drive position and the  indicator lamp flashes in the instrument cluster, the multifunction lever is not in position 0.

► **To switch on:** pull the multifunction lever to the desired brake level.

The  indicator lamp in the instrument cluster lights up.

The braking effect of the continuous brake is lowest in position 1 and highest in position 5.

► **To switch off:** push the multifunction lever to position 0.

The  indicator lamp in the instrument cluster goes out.

When ABS (Anti-lock Braking System) intervenes, the continuous brake is switched off. The  indicator lamp in the instrument cluster remains on.

Engine brake

The effectiveness of the engine brake depends on the engine speed. A high engine speed results in more effective engine braking.

Observe the effective engine braking range marked on the rev counter (► page 128).

At very low outside temperatures, the engine brake has limited or no effect after the engine has been started.

Retarder

If the  indicator lamp flashes in the instrument cluster, the retarder's braking power is reduced.

► Shift down in good time.

The engine braking effect and the engine cooling effect are increased.

Manual transmission

Important safety notes

WARNING

If there is a loss of pressure or insufficient reservoir pressure in the transmission/clutch circuit, you can no longer shift gears. There is a risk of an accident.

Do not pull away, or stop the vehicle as soon as possible, paying attention to road and traffic conditions. Secure the vehicle against rolling away, e.g. with the parking brake. Have the compressed-air system repaired at a qualified specialist workshop.

! Observe the following notes. You could otherwise damage the transmission, the engine or the clutch:

- do not drive with an engine speed that is too high or too low.
- only engage reverse gear with the engine at idling speed and the vehicle stationary.
- when changing gear, make sure that the engine speed does not enter the red over-revving range in the rev counter.
- release the gear lever when you have finished changing gear. Do not rest your hand or arm on the gear lever.
- if a warning tone sounds when downshifting, the maximum permissible engine speed has been exceeded. Shift to a higher gear, not a lower gear. The power-assisted gearshift is deactivated to protect the transmission synchronisation. As a result, more force is required when shifting gear.

The engine has delayed throttle response if:

- the vehicle is stationary
- the engine is running
- the transmission is in neutral.

In order to support a fuel-efficient driving style, the on-board computer displays a gearshift recommendation in the form of an arrow. Shift up ↑ or down ↓ according to the gearshift recommendation.

Changing gears

- ▶ Depress the clutch pedal.
- ▶ Shift the gear lever to neutral.
- ▶ If necessary, change the shift range.
- ▶ Use the gear lever to shift to the desired gear. Do not use excessive force.
- ▶ Slowly release the clutch pedal.
- ▶ To select the reverse gear: move the gear lever past the point of resistance into the reverse-gear gate with a gentle sideways tap of the hand on the gear lever.

9-speed transmission

General notes

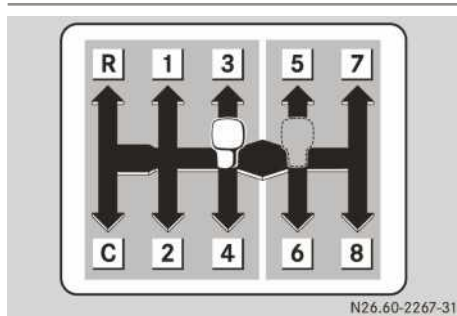

Gearshift pattern

The 9-speed transmission is a manually operated gearbox. The gearbox is equipped with a double-H gearshift.

When in neutral position, the gear lever is in the gate between 3rd and 4th gear, and 5th and 6th gear.

The shift ranges of the transmission are divided into:

- the low shift range "L" with:
 - reverse gear **R**
 - crawler gear **C**
 - gears **1** to **4**
- the high shift range "H" with gears **5** to **8**

Changing the shift range

- 1 Observe the following maximum permissible speed when changing shift range from the fast to the slow group.

When driving in the off-road gear of the transfer case, do not exceed the maximum speed of 20 km/h when changing gear. When driving in the road gear or when driving a vehicle without a transfer case, maintain a vehicle speed of less than approximately 25 km/h when changing gear.

If you change from the high-range group to the low-range group at high speed, the transmission may be damaged.

- ▶ Depress the clutch pedal.
- ▶ Shift the gear lever to neutral.
- ▶ Overcome the gear lever pressure point between the shift ranges with a gentle sideways tap of the hand on the gear lever.
- ▶ After approximately 1 second, select the desired gear without using excessive force.
- ▶ Slowly release the clutch pedal.

16-speed transmission

General notes

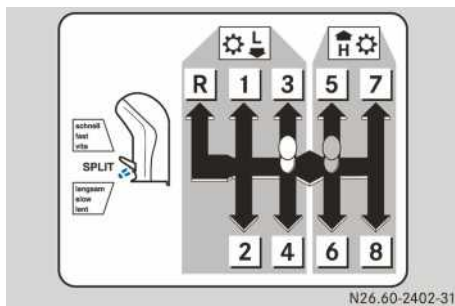

Gearshift pattern

The 16-speed transmission is a manually operated gearbox. The transmission is equipped with a double-H gearshift.

The additional gear reduction means that you can select a total of 16 forward gears and 2 reverse gears.

When in neutral position, the gear lever is in the gate between 3rd and 4th gear, and 5th and 6th gear.

The shift ranges of the transmission are divided into:

- the low shift range "L" with gears **1** to **4** and reverse gear **R**
- the high shift range "H" with gears **5** to **8**
- the splitter groups with the switch on the front side of the gear lever

Gearshift options

You can shift gears:

- in the selected low-range splitter group, e.g. off-road driving
- in the selected high-range splitter group, e.g. on-road driving
- between low-range and high-range splitter groups, e.g. when the vehicle is laden

Changing the shift range

! Observe the following maximum permissible speed when changing shift range from the fast to the slow group.

When driving in the off-road gear of the transfer case, do not exceed the maximum speed of 15 km/h when changing gear. When driving in the road gear or when driving a vehicle without a transfer case, maintain a vehicle speed of less than approximately 20 km/h when changing gear.

If you change from the high-range group to the low-range group at high speed, the transmission may be damaged.

- ▶ Depress the clutch pedal.
- ▶ Shift the gear lever to neutral.
- ▶ Overcome the gear lever pressure point between the shift ranges with a gentle side-ways tap of the hand on the gear lever.
- ▶ After approximately 1 second, select the desired gear without using excessive force.
- ▶ Slowly release the clutch pedal.

Selecting the splitter group

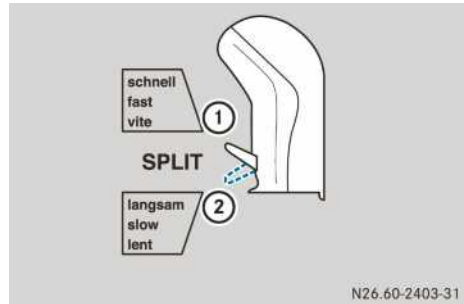

By selecting a splitter group, you select a low-range or high-range ratio for the gear selected without changing gear itself.

- ▶ Move the splitter switch to the upper position for high-range splitter group **1** or to the lower position for low-range splitter group **2**.
- ▶ Depress and hold the clutch pedal until the splitter group is engaged.
- ▶ Release the clutch pedal.

Automated transmission

Important safety notes

! WARNING

If there is a loss of pressure or insufficient reservoir pressure in the transmission/clutch circuit, you can no longer shift gears. There is a risk of an accident.

Do not pull away, or stop the vehicle as soon as possible, paying attention to road and traffic conditions. Secure the vehicle against rolling away, e.g. with the parking brake. Have the compressed-air system repaired at a qualified specialist workshop.

The vehicle has a selectable crawler mode. When crawler mode is activated, the vehicle crawls automatically when the service brake is released and continues rolling at the engine idling speed.

Multifunction lever and gear indicator

General notes

Mercedes PowerShift is equipped with 8, 12 or 16 forward gears and 2 or 4 reverse gears.

When driving, the transmission control controls clutch and gear operation, e.g. when:

- Pulling away
- Manoeuvring
- changing gear
- Stopping

If Mercedes PowerShift is malfunctioning, you can continue to drive in backup drive mode (▷ page 140).

Multifunction lever

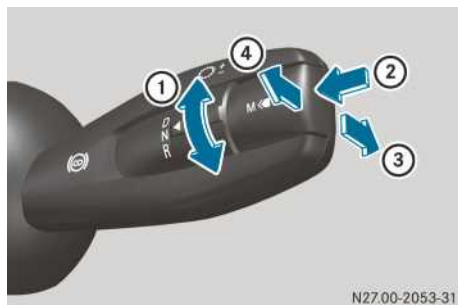

N27.00-2053-31

- ① To select the direction of travel:
 - D** Drive (▷ page 258)
 - N** Neutral (▷ page 259)
 - R** Reverse (▷ page 261)
- ② To select a drive program (▷ page 255):
 - A** Automatic drive program with the drive and vehicle-specific gearshift program
 - M** Manual drive program
- ③ **-** To shift down manually with the automatic (▷ page 259)/manual (▷ page 260) drive program
- ④ **+** To shift up manually with the automatic (▷ page 259)/manual (▷ page 260) drive program

Gear indicator

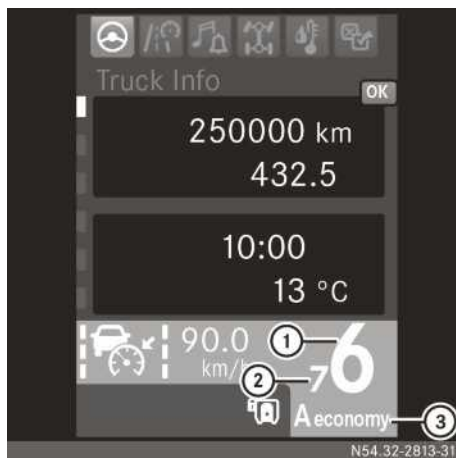

Gear indicator in the display of the on-board computer

- ① Direction of travel and/or selected gear
- ② Gearshift recommendation (shift up ↑/shift down ↓) or preselected gear (flashing)
- ③ Drive program

Possible displays:

1 - 16	1st to 16th gear
N	Neutral position
N1	Low-range splitter group
N2	High-range splitter group
E	Neutral position in EcoRoll mode
R1 - R4	1st to 4th reverse gear
A	Automatic drive program
A economy, A power, A fleet, A offroad, A municip or A fire-sv	Automatic drive program with drive-specific and vehicle-specific gearshift program
M	Manual drive program

Drive programs and drive functions

Automatic

The transmission control shifts gears depending on a number of factors including:

- engine speed
- accelerator pedal position
- application of the continuous brake
- load status of the vehicle
- condition of the road surface

In addition, EcoRoll mode and crawler mode can be deactivated and activated as drive functions using the **Systems** menu window in the  settings menu (▷ page 149).

On vehicles without a hydrodynamic clutch and with the **offroad** gearshift program, the crawler mode, which is specially suited for driving off-road, can be activated or deactivated using the  button (▷ page 257).



Automatic transmission with drive-specific gearshift program

Depending on the type of transmission and programming, the gearshift program is either designed for:

- the performance-oriented dynamic driving mode with higher engine speeds – **power** or
- the driving mode that saves fuel – **economy** or
- the performance-oriented driving mode with higher engine speeds for light off-road terrain and building sites – **offroad** or
- the performance-oriented dynamic driving mode with higher engine speeds and a high gross combination weight – **heavy** or
- fleet mode – **fleet** or
- refuse collection vehicle – **municip** or
- the dynamic driving mode with optimal acceleration for emergency callouts and journeys when sirens are used on fire engines – **fire-sv**

In the **power**, **offroad**, **heavy** and **fire-sv** gearshift programs, automatic control only shifts to the next gear at higher engine speeds. EcoRoll mode cannot be activated in these gearshift programs.

In the **offroad** gearshift program, the crawler mode adapted for road use is deactivated. On vehicles without a hydrodynamic clutch, the specially adapted crawler mode for driving off-

road can be activated using the  button (▷ page 257). Crawler mode can be deactivated and activated using the **Systems** menu window in the  settings menu (▷ page 151).

In the **heavy** gearshift program, the transmission is not automatically shifted up when you depress and hold the accelerator pedal over the point of resistance (kickdown).

In the **economy** gearshift program:

- EcoRoll mode is always activated
- the adjustable speed of cruise control is limited to 85 km/h

In the **fleet** gearshift program:

- EcoRoll mode is always activated
- the maximum speed is limited to approximately 85 km/h
- the automatic drive program is always active, except in reverse gear

In the **municip** gearshift program:

- the previously selected drive program is always active after starting the engine
- EcoRoll mode is deactivated
- crawler mode is deactivated
- the acoustic clutch overload warning is deactivated

Manual drive program

In the manual drive program, the driver is responsible for selecting gears. The gearshift recommendation is shown in the status area of the on-board computer.

In particularly difficult driving conditions, switch to the manual driving program. This will enable you to avoid any undesired interruptions to the tractive power that may occur with automatic gearshifting.

Drive program selection



Multifunction lever

You cannot activate the manual drive program in vehicles with the **fleet** gearshift program. Also, you will be unable to select another gearshift program.

When the engine has been started, an automatic control drive program is always activated. On vehicles with the **power** gearshift program, this is the standard automatic control, **A**. On vehicles with the **fire-sv** gearshift program, this is always the **A fire-sv** program.

On vehicles with the **economy**, **heavy**, **municip** or **offroad** gearshift program, this is the previously selected drive program.

After the display check, **A** or e.g. **A economy** and **N** or **N 1** appear in the display.

You can switch between the drive programs at any time.

▶ To activate the manual drive program:

press and hold the **[A/M]** button ①.

The display shows manual drive program **M**, the selected gear and a gearshift recommendation.

▶ To activate the automatic drive program:

briefly press the **[A/M]** button ①.

The display shows automatic drive program **A**, the selected and the preselected gear.

▶ To change the gearshift program of the automatic drive program:

briefly press the **[A/M]** button ①.

If the display shows **A**, the standard gearshift program is activated.

If the display shows, for example, **A economy** or **A power**, the drive-specific gearshift program is activated.

If the transmission control detects no demand for additional power for more than 1 minute when in the **A power** gearshift pro-

gram, the transmission control automatically shifts to the standard gearshift program with lower fuel consumption.

EcoRoll mode

EcoRoll mode allows an economic driving style. If you do not depress the accelerator pedal when driving, the transmission control shifts to neutral, depending on driving conditions. **E** then appears in the display.

The transmission does not shift into neutral or from neutral to a suitable gear if:

- you depress the accelerator pedal
- you depress the service brake pedal
- you apply the continuous brake
- cruise control or the distance control assistant brakes or accelerates the vehicle
- the speed limiter is active and the set limit speed is exceeded
- the speed set for cruise control is exceeded by more than approximately 6 km/h (default setting), or the road speed tolerance that you have set is exceeded
- a programmed speed limit is exceeded by approximately 4 km/h
- you leave a certain engine speed or speed range
- the gross combination weight is very high

In the **power**, **heavy**, **municip**, **offroad** and **fire-sv** gearshift programs, EcoRoll mode is always deactivated and cannot be activated. In standard drive program **A** and in the other gearshift programs, EcoRoll mode is always activated once the engine is started. EcoRoll mode can be deactivated and activated in standard drive program **A** using the **Systems** menu window in the **[R]** settings menu (▷ page 151).

i EcoRoll mode cannot be deactivated when gearshift programs **economy** and **fleet** have been selected.

EcoRoll mode is active above speeds of approximately 35 km/h.

i When EcoRoll mode is activated, steering forces on the multifunction steering wheel may be somewhat greater under certain driving conditions, e.g. on gently winding downhill inclines. This does not jeopardise operating or road safety.

Crawler mode

General notes

Crawler mode enables the vehicle to crawl forwards automatically when the service brake is released and to coast in neutral when the accelerator pedal is not depressed. After crawling forwards, the vehicle coasts in neutral until you bring the vehicle to a halt using the service brake or until crawler mode is deactivated/cancelled.

Crawling and coasting are possible in all pulling-away gears. You can shift gear manually, e.g. in a traffic jam, and adjust your coasting speed to the traffic conditions.

Crawler mode is deactivated automatically if:

- you shift the transmission to neutral position **N** for longer than approximately 2 seconds
- you apply the parking brake
- you activate the rocking-free drive function
- the distance control assistant intervenes
- the idling speed is above approximately 700 rpm
- Active Brake Assist has intervened
- backup drive mode is enabled
- the clutch is about to overload
- a change of direction cannot be performed

If no further conditions are met, crawler mode is reactivated when you pull away using the accelerator pedal.

Crawler mode is cancelled automatically when its functional limits are reached.

This is the case if:

- the vehicle does not move, e.g. due to unexpectedly high driving resistance
- the wheels spin, e.g. on slippery road surfaces
- driving resistance exceeds a predetermined value when crawling/coasting in neutral

If crawler mode has been cancelled automatically, the on-board computer shows the **Crawler mode cancelled** event window. A warning tone sounds and the transmission control disengages the clutch. In this case, depress the brake pedal to bring the vehicle to a halt or depress the accelerator pedal to pull away again. If you do not depress the brake or accelerator pedal, crawler mode is deactivated. It will only be available again when you pull away by depressing the accelerator pedal.

On vehicles without a driven front axle, crawler mode is adapted for road driving. Crawler mode

tuned for road driving can be deactivated and activated using the **Systems** menu window in the  settings menu (▷ page 151).

In the **offroad** gearshift program, the crawler mode adapted for road driving is always deactivated. The crawler mode adapted specially for off-road driving can be activated and deactivated in all permissible pulling-away gears using the  button (▷ page 257).

In standard drive program **A** and in the other gearshift programs, crawler mode adapted for road driving is always activated once the engine is started.

On vehicles with all-wheel drive, crawler mode is always deactivated once the engine is started.



When you activate the corresponding crawler mode, it is activated after you pull away for the first time. The maximum torque for crawler mode is not available when crawling for the first time after the mode has been activated.

If you switch to the manual drive program, the current crawler mode remains active. If you then switch back to the automatic drive program, the crawler mode assigned to that drive and gearshift program is activated. It may only be available again when you next pull away by depressing the accelerator pedal.

Activating or deactivating crawler mode with the button (all-wheel drive vehicles)



The crawler mode adapted especially for off-road driving and all-wheel drive vehicles is always deactivated once the engine is started. The indicator lamp in the  button lights up.

- ▶ **To activate:** select a pulling-away gear.
- ▶ Press the lower section of the  button. The indicator lamp in the  button goes out.
- ▶ Depress the accelerator pedal and pull away. Crawler mode is activated.

i If you do not pull away immediately after pressing the button, the indicator lamp in the  button lights up again. Crawler mode then remains deactivated.

► **To deactivate:** press the lower section of the  button again.

The indicator lamp in the  button lights up.

Crawler mode is deactivated automatically if you:

- select a gear above the permissible pulling-away gears
- shift the transmission to neutral position
- apply the parking brake
- activate the rocking-free drive function

Rocking-free

General notes

! If the gross tractor/trailer combination weight is very high, the dry clutch may be overloaded and damaged.

You can use the rocking-free drive function in all permissible pulling-away gears to rock the vehicle out of a depression in the terrain. Transmission control switches to the manual drive program automatically once the rocking-free drive function has been activated. If you release the accelerator pedal when rocking free, the dry clutch is immediately disengaged and the vehicle rolls back. If you depress the accelerator pedal again, the dry clutch engages immediately and the vehicle pulls away.

After selecting the pulling-away gear, activate or deactivate the rocking-free drive function via the **Systems** menu window in the  settings menu (► page 151).



In all-wheel drive vehicles, you can activate or deactivate the rocking-free drive function using the  button after selecting the pulling-away gear.

The rocking-free drive function is deactivated automatically when:

- you are driving faster than approximately 8 km/h
- you select a gear above the permissible pulling-away gears
- the on-board computer displays the **Clutch under heavy strain** event window in vehicles with a hydrodynamic clutch

Activating or deactivating rocking-free using the button (all-wheel drive vehicles)



► Push the upper section of the  button. When the indicator lamp in the  button lights up, the rocking-free drive function has been activated.

Pulling away and stopping the vehicle

Pulling away

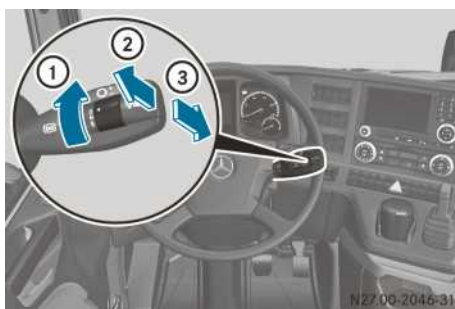

Multifunction lever

Depending on the transmission, various pulling-away gears can be selected. For the 8-speed transmission 1st - 2nd; for the 12-speed transmission, 1st - 6th; and for the 16-speed transmission, 1st - 8th gear can be selected.

If the clutch is under a heavy load, you can only pull away in 1st gear. In the **municip** gearshift program, you cannot select a gear higher than 2nd to pull away (► page 153).

- Start the engine.
 - Turn the direction of travel selection switch to the **D** position (drive) ①.
- In all drive programs, the transmission control selects a suitable pulling-away gear, which

can be changed manually, depending on the vehicle load.

- ▶ Release the brake pedal or parking brake and depress the accelerator pedal. To achieve higher torque, the engine speed may increase to approximately 1100 rpm when pulling away in 1st gear with the accelerator pedal fully depressed. The engine speed is automatically increased as required for pulling away.

Changing the starting gear

- ▶ Pull the multifunction lever up briefly (to shift up) ② or push it down briefly (to shift down) ③. The transmission control shifts up or down 1 gear. The gear change is complete when the display shows the selected gear.

or

- ▶ Vehicles with 12/16-speed transmission: pull the multifunction lever up and hold (to shift up) ② or push it down and hold (to shift down) ③. Vehicles with a 12-speed transmission: the transmission shifts up or down to 1st, 3rd or 6th gear. The gear change is complete when 1, 3 or 6 is shown in the display. Vehicles with a 16-speed transmission: the transmission shifts up or down to 1st, 4th or 8th gear. The gear change is complete when 1, 4 or 8 is shown in the display.

If you release the service brake after stopping the vehicle for the first time, the vehicle begins to crawl (▷ page 257).

Stopping

- ▶ Depress the brake pedal. The transmission control shifts back, depending on driving conditions, and into a suitable pulling-away gear shortly before the vehicle comes to a standstill. If you release the service brake after stopping the vehicle, the vehicle begins to crawl again.

Information on crawling and coasting in neutral can be found in the "Crawler mode" section (▷ page 257).

Automatic neutral position

If the vehicle is stationary for approximately 9 minutes with a gear engaged and the engine running, a warning tone will sound. **N** flashes in the display. After a further minute, the transmission control automatically shifts to the neutral position.

Shifting into neutral



Multifunction lever

Shift the transmission to neutral when stopping for a longer time, e.g. at traffic lights or before stopping the engine.

- ▶ Depress the brake pedal or apply the parking brake.
- ▶ Turn the direction of travel selection switch to the **N** position (neutral) ①. When **N1** or **N2** is shown in the display, the gear change is complete.

Driving using the automatic drive program

Accelerating

You can use the accelerator pedal position to actively influence the shift point:

- light throttle: early upshift
- heavy throttle: late upshift
- kickdown: maximum upshift delay and extremely early downshift

i The kickdown function is limited when using the **economy** and **fleet** gearshift programs.

If the continuous brake is activated and you shift up on downhill gradients, the transmission control limits the gear change based on the vehicle weight and the gradient.

Kickdown gearshifting

Use kickdown for maximum acceleration of the vehicle.

You can increase performance when pulling away using the kickdown function if required, e.g. on steep uphill gradients. When pulling away in 1st gear, the kickdown function enables an increased pulling-away engine speed.

- ▶ Depress the accelerator pedal past the pressure point to the stop.
The transmission control shifts to a lower gear as required.
- ▶ Ease off the accelerator pedal slightly once the desired speed is reached.
The transmission control shifts up again.

Decelerating

- ▶ Release the accelerator pedal.
 - ▶ Depress the brake pedal.
- or
- ▶ Activate the continuous brake.
The transmission control shifts down automatically according to the driving situation.

Selecting a gear manually

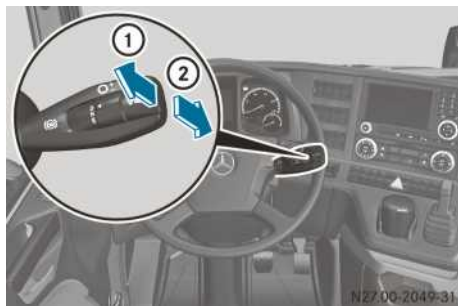

You can also select a different gear manually. The automatic control functions are not changed by doing this.

Changing gear while driving is only possible at suitable engine speeds or at suitable driving speeds. A warning tone will sound if the engine speed has not been achieved or if the driving speed is too high. The gear is not selected. The transmission control only selects permissible gears.

- ▶ Pull the multifunction lever up briefly (to shift up) ① or push it down briefly (to shift down) ②.

The transmission control shifts up or down 1 gear. The gear change is complete when the display shows the selected gear.

or

- ▶ Briefly pull the multifunction lever up repeatedly (to shift up) ① or push it down briefly (to shift down) ② a corresponding number of times.

The transmission control shifts several gears up or down. The gear change is complete when the display shows the selected gear.

or

- ▶ Pull and hold the multifunction lever up (to shift up) ① or push and hold it down (to shift down) ②.

The transmission control determines the most suitable gear (target gear) for the desired gearshift direction, depending on the vehicle load. The transmission control shifts up or down at least one gear to a suitable gear. The gear change is complete when the display shows the selected gear.

Driving using the manual drive program

General notes

In the manual drive program, the driver is responsible for selecting gears.

In particularly difficult driving conditions, switch to the manual driving program. This will enable you to avoid any undesired interruptions to the tractive power that may occur with automatic gearshifting.

In order to support a fuel-efficient driving style, the on-board computer displays a gearshift recommendation in the form of an arrow. Shift up ↑ or down ↓ according to the gearshift recommendation.

Changing gear while driving is only possible at suitable engine speeds or at suitable driving speeds. A warning tone will sound if the engine speed has not been achieved or if the driving speed is too high. The gear is not selected. The transmission control only selects permissible gears.

Shifting gears



- ▶ Pull the multifunction lever up briefly (to shift up) ① or push it down briefly (to shift down) ②.

The transmission control shifts up or down 1 gear. The gear change is complete when the display shows the selected gear.

or

- ▶ Briefly pull the multifunction lever up repeatedly (to shift up) ① or push it down briefly (to shift down) ② a corresponding number of times.

The transmission control shifts several gears up or down. The gear change is complete when the display shows the selected gear.

or

- ▶ Pull and hold the multifunction lever up (to shift up) ① or push and hold it down (to shift down) ②.

The transmission control determines the most suitable gear (target gear) for the desired gearshift direction, depending on the vehicle load. The transmission control shifts up or down at least one gear to a suitable gear. The gear change is complete when the display shows the selected gear.

Reverse gear and changing direction quickly



Multifunction lever

To pull away, you can only shift from neutral to the 1st or 2nd reverse gear.

When you shift to reverse gear, the manual drive program is activated. You can switch to the automatic drive program.

With the vehicle stationary and the transmission in neutral:

- ▶ Depress the brake pedal or apply the parking brake.
- ▶ Turn the direction of travel selection switch to the **R** position (to reverse) ①. The gear change is complete when **R1** is shown in the display.

Vehicles with a reverse warning device: the reverse warning device sounds.

Shifting to 2nd reverse gear

- ▶ Pull the multifunction lever up briefly (to shift up) ②. The gear change is complete when **R2** is shown in the display.
- ▶ Release the brake pedal or parking brake and slowly depress the accelerator.

You can shift up or down by single reverse gears in succession while reversing:

- ▶ Pull the multifunction lever up briefly (to shift up) ② or push it down briefly (to shift down) ③. The gear change is complete when the next higher or next lower reverse gear appears in the display.

Shifting to the reverse gears while the vehicle is in motion is only possible at suitable engine speeds or driving speeds. A warning tone will sound if the engine speed has not been achieved

or if the driving speed is too high. The selected reverse gear is not engaged. The transmission control only selects permissible reverse gears. If you bring the vehicle to a halt in 2nd, 3rd or 4th reverse gear, the transmission control shifts to 1st reverse gear.

Automatic transmission

Important safety notes

! When the transmission is set to neutral position, only let the vehicle roll for short periods. Prolonged rolling of the wheels, e.g. when being towed, will result in transmission damage.

While the continuous brake (engine brake/retarder) is activated, the engine speed for downshifts is higher than when the continuous brake is not applied.

Pay attention to the on-board computer's event messages, which indicate particular operating states and help to prevent damage to the automatic transmission.

The automatic transmission features touch-key gearshift. The touch-key gearshift is on the engine tunnel next to the driver's seat.

The individual gears are shifted automatically depending on:

- shift range
- speed
- accelerator pedal position
- drive program
- engine brake and/or retarder

You can restrict or derestrict the shift range at any time.

Touch-key gearshift and gear indicator

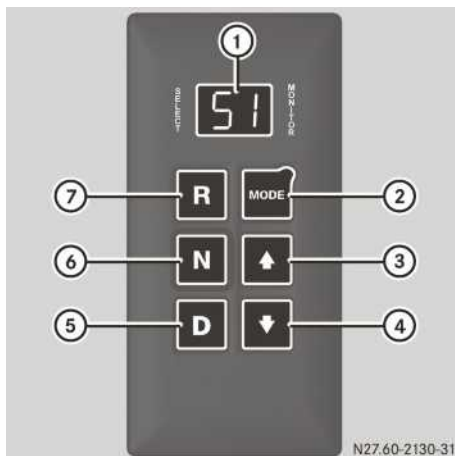

- ① Display
Left: selected shift range, e.g. **5**
Right: selected gear, e.g. **1**
Economy or **Power** drive program
- ② MODE button
- ③ To extend the shift range
- ④ To restrict the shift range
- ⑤ Drive position **D**
- ⑥ Neutral **N**
- ⑦ Reverse gear **R**



Shift ranges

Display ① shows the selected shift range on the left and the selected gear on the right, e.g. **5**
1.



R	Reverse gear Only engage reverse gear when the vehicle is stationary and the engine is at idling speed.
N	Neutral position Power transmission from the engine to the drive axle is disconnected. When you release the service brake and the parking brake, the vehicle can be moved freely. When transmission is set to neutral position, the indicator lamp lights up in the instrument cluster.

D Drive position

The automatic transmission automatically shifts all five or six forward gears. The drive position will provide optimal driving characteristics in almost all operating circumstances.

The left part of display ① shows  (5-speed transmission) or  (6-speed transmission).



While driving, you can restrict or derestrict the shift range manually for uphill or downhill gradients using the  and  buttons.

Drive programs

The automatic transmission offers the **Economy** and **Power** drive programs. The drive programs support your desired driving style.

The **Economy** drive program is designed for a comfortable, economic driving style and makes driving on slippery road surfaces easier.

The **Power** drive program is designed for driving where high performance or driving dynamics are required.

After starting the engine, the standard drive program **Economy** is always active.



On fire engines, the standard drive program is the **Power** drive program and this is always active after starting the engine.

You can switch between the drive programs at any time.

► **To change drive program:** press MODE button ②.

Display ① only shows the active drive program when this is not the standard drive program.

Pulling away and stopping the vehicle**Pulling away**

- Depress the brake pedal.
- Press the  or  button.
Vehicles with reverse warning device: if reverse gear is engaged, the reverse warning device sounds.

► If the  indicator lamp goes out in the instrument cluster, release the brake pedal.

► Depress the accelerator pedal.

i If the automatic transmission is cold (transmission fluid temperatures below $-5\text{ }^{\circ}\text{C}$), the electronic management system only selects reverse gear or the 2nd forward gear. When the transmission fluid temperature returns to above $-5\text{ }^{\circ}\text{C}$, all gears may be engaged again.

Stopping

! When the transmission is set to neutral position, only let the vehicle roll for short periods. Prolonged rolling of the wheels, e.g. when being towed, will result in transmission damage.

While the continuous brake (engine brake/retarder) is activated, the engine speed for downshifts is higher than when the continuous brake is not applied.

When stopping briefly, e.g. at traffic lights:

► Maintain the gear position and stop the vehicle with the service brake.

When stopping for a longer period with the engine running:

► Shift the transmission to neutral position. The  indicator lamp in the instrument cluster lights up.

Driving tips**Accelerating**

You can use the accelerator pedal position to actively influence the shift point:

- light throttle application: early upshift
- heavy throttle application: late upshift
- kickdown: maximum upshift delay and extremely early downshift

Kickdown gear shifting

Use kickdown to increase performance and, if necessary, for maximum vehicle acceleration.

- ▶ Depress the accelerator pedal past the pressure point to the stop.
The automatic transmission shifts down to a lower gear depending on the engine speed.
- ▶ Ease off the accelerator pedal slightly once the desired speed is reached.
The automatic transmission shifts up again.

Driving on uphill and downhill gradients

I If you have restricted the shift range, make sure that the engine revs do not enter the red danger zone in the rev counter. Exceeding the limiting speed for longer periods can result in engine damage.

When driving on extreme uphill gradients or long downhill gradients, shift to a shift range with high engine performance and engine braking effect in good time.

Manoeuvring and rocking free

Manoeuvring in a tight space:

- ▶ Control the vehicle's speed by measured application of the brakes.
 - ▶ Depress the accelerator moderately and steadily.
- i** You can shift back and forth between drive position **D** and reverse gear **R** at low speeds without applying the brakes. This helps when manoeuvring rapidly or when rocking the vehicle out of snow or slush, for example.

Operation

Hydrodynamic clutch

General notes

The hydrodynamic clutch (turbo retarder clutch) assists you when pulling away and braking (primary retarder).

The oil temperature increases when you drive in hydrodynamic clutch mode. If the oil temperature is too high, an event window is displayed and a warning tone sounds. Shift to a lower gear to decrease the oil temperature.

If the event window and warning tone persist:

- ▶ Brake the vehicle and stop, paying attention to road and traffic conditions.
- ▶ Apply the parking brake.
- ▶ Shift into neutral.
- ▶ Let the engine run at approximately 1,200 rpm for approximately 1 minute.
- ▶ If the event window and the warning tone persist: have the hydraulic clutch checked at a qualified specialist workshop.

Pulling away

General notes

You should primarily use the automatic operating mode when pulling away. The Mercedes PowerShift transmission system automatically determines the optimal gear and shift point. Depending on the driving resistance, the dry clutch opens or closes.

You can pull away at low engine speeds with maximum torque (approximately 1,200 rpm).

Only when the manoeuvring mode is switched on can the vehicle crawl forward automatically and coast after the service brake is released (▷ page 265).

i The transmission does not change gear when driving in clutch mode.

Level ground



- ▶ Select a gear.
- ▶ Depress the accelerator pedal and release the parking brake.
The  indicator lamp in the instrument cluster lights up.

The hydrodynamic clutch is filled and the vehicle pulls away. After pulling away, the  indicator lamp in the instrument cluster goes out and power is transmitted via the dry clutch.

Gradients

How the vehicle pulls away depends on:

- the gradient of the road surface
- the gross tractor/trailer combination weight
- how quickly you depress the accelerator pedal

- ▶ Apply the parking brake or activate the hill holder.
- ▶ Switch on automatic mode.
The electronics change the gears quickly and accurately.
- ▶ Select a gear.
- ▶ Depress the accelerator pedal and release the parking brake.
The  indicator lamp in the instrument cluster lights up.
The hydrodynamic clutch is filled and the vehicle pulls away. After pulling away, the  indicator lamp in the instrument cluster goes out and power is transmitted via the dry clutch.

Hydromove

The hydromove drive function allows you to drive down inclines slowly, in a controlled manner.

You can move the vehicle forwards or backwards on an uphill gradient using only the accelerator. This is particularly of benefit when operating the vehicle with a trailer containing a heavy load as you do not need to change gear or depress the service brake. To do this you must select a pulling-away gear for the direction opposite to your desired direction of travel.

The drive function is always automatically activated when you start the engine. The drive function is only automatically deactivated in the **off-road** gearshift program.

Activate or deactivate the hydromove drive function via the **Systems** menu window in the  settings menu (▶ page 151).

- ▶ Stop the vehicle using the service brake.
- ▶ Depress the brake pedal.
- ▶ Activate the hydromove drive function in off-road mode.
- ▶ If you want to reverse down a gradient slowly: turn the direction switch to **D** (▶ page 254).
- ▶ If you want to drive down a gradient slowly: turn the direction switch to **R** (▶ page 254).
- ▶ **To descend slowly:** release the service brake.
Do not depress the accelerator.
- ▶ **To descend quickly:** depress the accelerator slightly.

- ▶ **To slow down and stop:** continue to depress the accelerator.
- ▶ **Driving back up uphill gradients:** depress the accelerator further.
If power is provided, the vehicle will continue to drive up the incline.

Manoeuvring mode

General notes

On vehicles with a hydrodynamic clutch, manoeuvring mode allows you to manoeuvre more precisely. You can also pull away using manoeuvring mode and deactivate manoeuvring mode to continue driving. The starting power is higher in the **power, heavy** and **off-road** gearshift programs.



In manoeuvring mode, the vehicle starts up as soon as you release the service brake – automatic forward crawling.

Manoeuvring mode does not deactivate automatically.

When manoeuvring mode is active, the transmission does not change gear automatically. It is possible to deactivate manoeuvring mode by depressing the accelerator pedal beyond the point of resistance (kickdown).

Activating manoeuvring mode



- ▶ Stop the vehicle, leaving the engine running.
- ▶ Depress the brake pedal.
- ▶ Press the  button.
The indicator lamp in the  button lights up.
The engine speed is limited to 1,300 rpm in manoeuvring mode and the transmission changes to the manual drive program **M**.

- ▶ Select a suitable pulling-away gear based on the gross train weight.
All pulling-away gears are available.
- ▶ Release the brake pedal.
The vehicle is, depending on the load and gradient, either held or will roll down the uphill gradient with the brakes applied.
- ❗ When manoeuvring mode is active, it is only possible to change gears when the vehicle is stationary and the brake pedal is depressed.

Deactivating manoeuvring mode

- ▶ Press the lower section of the  button again.

or

- ▶ Depress the accelerator pedal past the pressure point to the stop (kickdown).
The indicator lamp in the  button goes out.

Axle and wheel loads

- ❗ Do not exceed the maximum permissible gross vehicle weight. Observe the permissible axle and wheel loads. Avoid one-sided wheel loads. The difference between wheel loads must not exceed 4% of the actual, existing axle load.

The following parts of the vehicle may otherwise be damaged:

- tyres
- chassis
- axles

- ❗ Observe the maximum gross axle weight when tipping, rolling away or setting down demountable bodies or containers. Do not exceed the values given in the body/equipment mounting directive.

The following parts of the vehicle may otherwise be damaged:

- tyres
- chassis
- axles

Information on the body/equipment mounting directives (▷ page 32).

While driving, pay regular attention to the indicator and warning lamps and the displays on the on-board computer.

ASR (acceleration skid control)

Driving with ASR



ASR can neither reduce the risk of an accident nor override the laws of physics if the driver does not pay attention when pulling away or accelerating. ASR is only an aid. You should always adapt your driving style to suit prevailing road and weather conditions.

ASR considerably improves traction, i.e. power transmission between the tyres and the road surface, and therefore also improves the vehicle's driving stability. ASR assists with pulling away and accelerating, particularly on slippery surfaces.

If the drive wheels:

- spin on one or both sides of the vehicle, ASR is activated automatically
- spin on one side, ASR brakes them automatically
- spin on both sides, ASR automatically reduces the engine's power output

If ASR intervenes:

- the  indicator lamp in the instrument cluster flashes
- you cannot activate cruise control
- and cruise control has already been activated, it will remain active. It is not possible to accelerate or decelerate using cruise control.
- ▶ Switch the ignition lock to the drive position. The  indicator lamp in the instrument cluster lights up and goes out after approximately 2 seconds. ASR is activated.

If the  indicator lamp does not go out, then ASR has a malfunction. Have the cause of the malfunction rectified at a qualified specialist workshop.

Deactivating/activating ASR



WARNING

If deactivated, ASR will not attempt to stabilise the vehicle during pulling away and acceleration. There is an increased risk of skidding and of an accident.

Only deactivate ASR in the situations described in the following.



Vehicles with Stability Control Assist have no  button. Traction control (ASR function) is part of Stability Control Assist. If you deactivate Stability Control Assist, traction control is also deactivated (▷ page 267).

- ▶ If traction problems occur when driving with snow chains or driving on loose surfaces, e.g. gravel, deactivate ASR.
- ▶ **For vehicles with several driven rear axles:** if the road surface is slippery, engage the differential lock (▷ page 268).
- ▶ **To deactivate/activate:** press the  button.
If the  indicator lamp lights up, ASR is deactivated.

Stability Control Assist

Function and notes

Stability Control Assist monitors handling and traction, i.e. power transmission between the tyres and the road surface. If it detects that the vehicle is deviating from the direction desired by the driver, one or more wheels are braked to stabilise the vehicle. The engine output may also be modified to keep the vehicle on the desired course within physical limits. Stability Control Assist can also stabilise the vehicle during braking or in critical driving situations, e.g. sudden swerving or fast cornering.

Stability Control Assist is operational at speeds above approximately 20 km/h, regardless of the operating status of the service brake or continuous brake. If Stability Control Assist intervenes, the  indicator lamp in the instrument cluster flashes.

If you fail to adapt your driving style or if you are inattentive, Stability Control Assist can neither reduce the risk of an accident nor override the

laws of physics. Stability Control Assist is only an aid, and you are always responsible for the distance to the vehicle in front, for vehicle speed and for braking in good time. Always adapt your driving style to the prevailing road and weather conditions and maintain a sufficient, safe distance from other road users. Drive carefully.

When the engine is running and the  indicator lamp in the instrument cluster lights up permanently, Stability Control Assist is malfunctioning. Have Stability Control Assist checked at a qualified specialist workshop.

Regardless of the vehicle load or road surface conditions, Stability Control Assist reduces the risk that the tractor/semi-trailer combination or drawbar combination:

- skids
- jack-knives
- tips

Stability Control Assist stabilises a tractor/semi-trailer combination or drawbar combination with a maximum of 2 trailers/semi-trailers using the following automatic control interventions:

- engine output reduction
- targeted braking of individual wheels on the tractor vehicle
- targeted braking of the trailer/semi-trailer
- braking the entire tractor/semi-trailer combination or drawbar combination

When driving with more than two trailers/semi-trailers, the Stability Control Assist must be switched off.

Deactivating/activating Stability Control Assist

WARNING

If you deactivate Stability Control Assist, Stability Control Assist does not stabilize the vehicle. There is an increased risk of skidding and an accident.

Only deactivate Stability Control Assist in the situations described in the following.

It may be better to deactivate Stability Control Assist in the following situations:



- when driving on a loose surface
- when driving with snow chains
- when operating a snow plough

ASR is also deactivated. Activate Stability Control Assist as soon as the situations previously described are no longer present.

- ❗ If you drive with more than two trailers/semitrailers, you must switch off Stability Control Assist. Otherwise, malfunctions or faults can occur as a result.



When you start the engine, Stability Control Assist is automatically activated.

- ▶ Press the  button. If the  indicator lamp in the instrument cluster lights up, Stability Control Assist is deactivated.

Differential locks

WARNING

When driving off-road or driving with an engaged differential lock in the automatic driving program, the electronic management system may perform unwanted gear changes. Due to the interruption in the tractive power, the vehicle may roll backwards on uphill slopes, for instance. There is a risk of an accident.

Always drive carefully and be prepared to brake. In particularly difficult driving conditions, switch to the manual driving program.

WARNING

If you engage the differential locks when driving on a firm, high-traction surface, the steerability of the vehicle is severely impaired. You could lose control of the vehicle, especially when activating on a bend. There is a risk of an accident.

Disengage the differential locks immediately on a firm, high-traction surface.



WARNING

If ABS is deactivated, the wheels may lock when braked. As a result, the vehicle can no longer be steered. There is an increased risk of skidding and an accident.

Always leave ABS on when driving on roads and firm surfaces.

- ❗ Observe the following points. You could otherwise damage the differential lock.

- Do not engage the differential lock if the drive wheels are spinning.
- Engage the differential lock only when the vehicle is stationary or when travelling at walking pace.
- Do not engage the differential lock while depressing the accelerator or brake pedal.
- Pull away slowly after engaging the differential lock. The differential lock teeth may not be fully engaged.
- Do not drive on high-grip surfaces with the differential lock engaged.
- Do not exceed a maximum speed of 50 km/h with the differential lock engaged.

- ❗ If the  display flashes when the differential locks are switched off, briefly change speed, e.g. pull away, or change your direction of travel. Do not drive any further if the  display flashes. Otherwise, the differential gear system may be damaged.

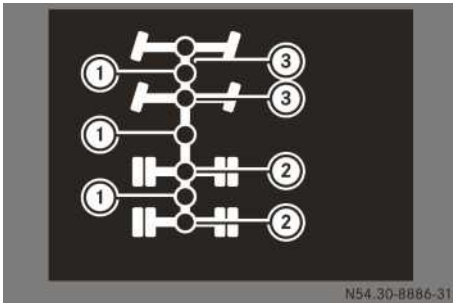

- 0 Differential locks disengaged
- 1 1 Shift position and inter-axle lock display
- 2 2 Shift position and cross-axle lock (rear axles) display
- 3 3 Shift position and cross-axle lock (front axles) display

Vehicles with one differential lock have a switch; vehicles with several differential locks have a control knob.

If the inter-axle lock and ABS are activated when driving off-road, it can lead to an interruption in the tractive power in the switch positions 1 or 2.

When the differential lock is engaged, the display shows ●. When the differential lock is disengaged, the display shows ○. If the ●

dot in the display is flashing, the differential lock has not yet engaged/disengaged. The conditions for engaging/disengaging have not been fulfilled, e.g. due to differing wheel rotational speeds. The differential lock is automatically engaged as soon as all gearshift conditions have been fulfilled.

Engage the differential locks to improve traction, e.g. on slippery road surfaces or off-road. The individual differential locks can only be engaged in sequence.

If a differential lock is engaged on vehicles with automated manual transmission, the shift range is automatically limited to upshifting.

During an ABS braking regulation, the inter-axle locks are disengaged and the dot flashes in the display. Once the ABS braking regulation is finished, the inter-axle locks are re-engaged and the front axle is re-engaged.

Activating

- ▶ Stop the vehicle.
- ▶ Vehicles with automated manual transmission: to avoid unwanted gear changes and interruptions in the tractive power in particularly difficult driving conditions, select the manual drive program (▶ page 255).
- ▶ Turn the differential lock control knob to position 1. The inter-axle locks in the inter-axle/transfer case are engaged. The indicator lamp lights up.
- ▶ Turn the differential lock control knob to position 2. The indicator lamp lights up.

or

- ▶ Press the upper section of the switch. The cross-axle locks on the rear axles are engaged.
- ▶ Turn the differential lock control knob to position 3. The cross-axle locks on the front axles are engaged. The and indicator lamps light up.

i The respective differential lock is only engaged when the display shows ●.

Deactivating

- i** **Vehicles with engaging all-wheel drive (code G4E):** if possible, disengage the inter-axle lock on a loose surface and not on a high-grip road surface. Otherwise, disengaging the

inter-axle lock can lead to a pressure surge and a noticeable jerk in the cab.

Even different tyre diameters between the front and rear axle can lead to a pressure surge when disengaging the inter-axle lock. Avoid a difference of more than 3% between the tyre diameters of the front and rear axle.

- ▶ Turn the differential lock switch to position .

The differential locks are disengaged. The differential lock indicators in the display go out.



The  and  indicator lamps go out.

or

- ▶ Press the lower section of the  switch. The differential lock is disengaged. The indicator for the differential lock in the display goes out.

The  and  indicator lamps go out.

- i** The respective differential lock is only disengaged when the display shows .

- ▶ If the  indicator flashes, briefly change your speed, e.g. pull away, brake or change your direction of travel. Do not drive on.
- ▶ If the  indicator does not go out when the inter-axle locks are disengaged, stop the vehicle and reverse it a short distance.

- i** If the differential locks are engaged and you drive faster than 50 km/h, the current status of the differential locks is again shown in the display. Disengage the differential locks or drive at a speed below 50 km/h.

Transfer case

Engaging the off-road gear

- !** Vehicles with retarder: do not exceed 50 km/h. You could otherwise damage the retarder.



N28.60-2011-31

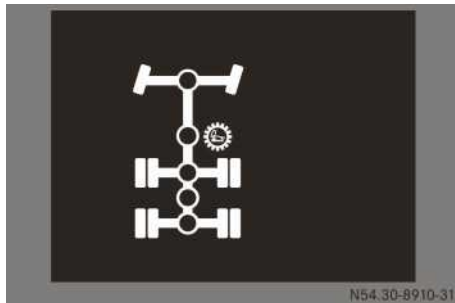

N54.30-9910-31



Engage the off-road gear to increase power to the driven axles off-road.

Off-road gear is engaged when all the engagement conditions are met. The display then shows the .





The display goes out when the off-road gear is disengaged and the road gear selected.

Even if all engagement conditions are met, changing gear on vehicles with a manual transmission can take up to three seconds.

If the off-road gear is selected on vehicles with an automated manual transmission, the shift range is automatically limited to upshifting.

If the inter-axle lock and ABS are activated when driving off-road, it can lead to an interruption in the tractive power in the switch positions  or .

- ▶ **To engage off-road gear:** stop the vehicle.
- ▶ Shift into neutral.
- ▶ Vehicles with automated manual transmission: to avoid unwanted gear changes and interruptions in the tractive power in particularly difficult driving conditions, select the manual drive program.
- ▶ Vehicles with automatic transmission: shift the transmission to neutral .

- ▶ Press the upper section of the  switch. When all engagement conditions are met, the off-road gear is engaged and the  symbol is shown in the display.
- ▶ Vehicles with a retarder: do not exceed a speed of 50 km/h while driving.
- ▶ **To disengage off-road gear:** stop the vehicle.
- ▶ Shift into neutral.
- ▶ Vehicles with automatic transmission: shift the transmission to neutral **[N]**.
- ▶ Press the lower section of the  switch. The off-road gear is disengaged when all engagement conditions are met. If the road gear is then reselected, the  indicator goes out in the display.

Engaging the front axle

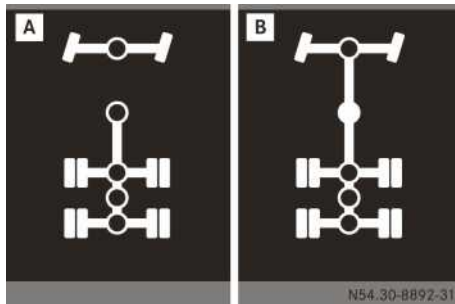

Engage the front axle to improve traction, e.g. on slippery road surfaces or off-road.

When you engage the front axle, **[B]** is shown in the display. If the front axle is not engaged, **[A]** is shown in the display. If the  dot flashes in the display, the front axle is not yet engaged/disengaged. The conditions for engaging/disengaging have not been fulfilled, e.g. due to differing wheel rotational speeds. The front axle will

be engaged/disengaged when all conditions for engaging/disengaging are fulfilled.

When you engage the front axle, the transfer case inter-axle lock is activated.

If the front axle is engaged on vehicles with an automated manual transmission, the shift range is automatically limited to upshifting.

When ABS intervenes, the inter-axle locks are deactivated, the front axle is disengaged and the display flashes. Once ABS has finished intervening, the inter-axle locks and the front axle are engaged again.

- ▶ **To engage the front axle:** stop the vehicle.
 - ▶ Turn the differential lock switch to **[1]**. The front axle and the rear axles are driven and the inter-axle locks are engaged. There is no rotational speed compensation between the front axle and the rear axles.
 - ▶ **To disengage the front axle:** stop the vehicle.
 - ▶ Turn the differential lock switch to **[0]**. Only the rear axles are driven. The inter-axle locks are deactivated.
- Positions **[2]** and **[3]** are the differential lock functions (> page 268).

Hydraulic additional drive system

Important safety notes

 **WARNING**
 When driving off-road, your body is subject to forces from all directions due to the uneven surface. You could be thrown from your seat, for instance. There is a danger of injury.
 Always wear a seat belt, even when driving off-road.

 **WARNING**
 If deactivated, ASR will not attempt to stabilise the vehicle during pulling away and acceleration. There is an increased risk of skidding and of an accident.
 Only deactivate ASR in the situations described in the following.

WARNING

If you deactivate ESP®, ESP® no longer stabilises the vehicle. There is an increased risk of skidding and an accident.



Only deactivate ESP® in the situations described in the following.

Depending on the switch and drive program selection, the hydraulic additional drive system drives the front axle up to a maximum speed of 25 km/h as required. This eases pulling away on uphill gradients and when driving off-road.

Avoid spinning the rear wheels when doing so. Engage the differential lock on the rear axle beforehand if necessary.

Activate the hydraulic additional drive system only when driving off-road.

The Stability Control Assist and ASR (acceleration skid control) are deactivated while the hydraulic additional drive system is being activated. The following indicator lamps light up:

- Stability Control Assist 
- ASR (acceleration skid control system) 

When you activate the hydraulic additional drive:

- crawler mode will be deactivated automatically (▷ page 257)
- you cannot activate the rocking-free drive function (▷ page 258)

Activating/deactivating

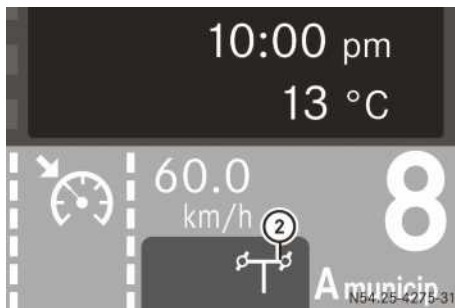

The hydraulic additional drive system can only be activated if:

- the engine is running
- the vehicle speed is below 60 km/h
- the hydraulic fluid has reached operating temperature
- a gear is engaged
- the rocking free drive function is disengaged
- there are no errors impairing safety or correct operation

The hydraulic additional drive is only active and switched on as needed when the following driving systems are switched off:

- Cruise control (▷ page 276)
- Distance control assistant (▷ page 278)



When cruise control or the distance control assistant is switched on, the hydraulic additional drive switches to standby mode.

Function display

Indicator lamp in button ①	Indicator lamp in status area ② of the on-board computer	Description
Off	No display	The hydraulic additional drive system is not activated.
Flashes	No display	The hydraulic fluid temperature is too high or too low.
On	White symbol	The hydraulic additional drive system is activated and in standby mode. The front wheels are not being driven yet.
On	Blue symbol	The hydraulic additional drive system is active. The front wheels are being driven. The Stability Control Assist and ASR are deactivated.

Activating

▶ Vehicles with a gross combination weight of more than 40 t: to avoid unwanted gear changes and interruptions in the tractive power in particularly difficult driving conditions, select the manual drive program (▷ page 255).

▶ Press the  button. When the indicator lamp in the  button flashes, the activation conditions have not been fulfilled.

The hydraulic additional drive system is automatically activated as soon as the following activation conditions have been fulfilled:



- the service brake is released
- the vehicle speed is below 15 km/h
- you depress the accelerator pedal

When the activation conditions have been fulfilled, the indicator lamp in the  button

lights up and the  indicator lamp in status area ② of the on-board computer lights up white. The hydraulic additional drive system is in standby mode.

When the front axle is being driven, the  indicator lamp in status area ② of the on-board computer lights up blue.

Deactivating

▶ Press the  button. The hydraulic additional drive system is deactivated. The indicator lamp in the  button and the  indicator lamp in status area ② of the on-board computer go out.

i The hydraulic additional drive system is automatically deactivated if:

- you exceed a vehicle speed of 60 km/h
- no gear is engaged
- the hydraulic fluid temperature deviates from the permissible operating temperature
- you switch off the ignition
- you switch the ignition off and on again
- there is an error impairing safety or correct operation

Checking the engine oil level

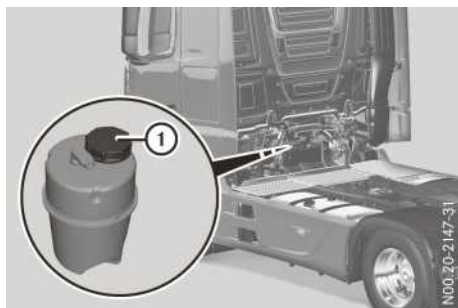

Before starting the journey, check the oil level of the hydraulic system when cold at an oil temperature of approximately 20 °C.

- ▶ Park the vehicle on a level surface.
- ▶ Apply the parking brake.
- ▶ Switch off the engine.
- ▶ Turn cap ① anti-clockwise and remove it.
- ▶ Pull out the oil dipstick, wipe with a clean, lint-free cloth and insert again.

- ▶ Pull out the oil dipstick again, check the oil level and correct if necessary.
- ▶ Insert the oil dipstick, replace the cap and tighten it as far as it will go.

Cleaning the radiator and fan



When regularly cleaning radiator ① and its fan, avoid malfunctions. To do so, observe the notes on cleaning the exterior (▶ page 349).

- ▶ Clean radiator ① and the fan blades with a compressed-air, steam or water jet. While doing so, guide the cleaning jet parallel to the radiator core fins and in the opposite direction to the airflow.
- ▶ After cleaning, dry the air side of the radiator with compressed air.

Idling speed







Buttons on the multifunction steering wheel

After the engine has started, the idling speed is controlled automatically according to the coolant temperature. The engine idling speed may differ in certain operating conditions depending on the engine or on vehicles with power take-off.



For the OM 470, OM 471 and OM 473 engines, the engine idling speed can be set between approximately 500 and 800 rpm. For the OM 936 engine, the engine idling speed can be set between approximately 600 and 800 rpm. For the OM 460 engine, the engine idling speed can be set between approximately 560 and 800 rpm. The engine idling speed may differ for special-purpose bodies.

The engine idling speed can be set via the on-board computer. This makes it possible to operate auxiliary equipment such as pumps at their working speed.

Setting the idling speed

- ▶ Press the  button on the multifunction steering wheel repeatedly until the **Engine speed** input window is shown in the on-board computer.
- ▶ Press the  or  button to increase or decrease the idling speed in approximately 20 rpm increments.
- ▶ Press the  button to exit the input window. or
- ▶ Wait for approximately 3 seconds. The setting is stored automatically.

Switching off the idling speed setting

- ▶ Press the  button. or
- ▶ Press the  button repeatedly until the on-board computer shows the **Engine speed** input window.
- ▶ Press the  button.

The increased idling speed is automatically reset if you drive faster than approximately 20 km/h.

Driving systems

Introduction to driving systems

The vehicle may be equipped with the following driving systems:

- Speed limiter (▶ page 275)
- Cruise control (▶ page 276)
- Distance control assistant (▶ page 278)
- PPC (▶ page 282)
- Active Brake Assist (▶ page 284)
- Lane Keeping Assist (▶ page 290)
- ATTENTION ASSIST (▶ page 291)

With the right-hand button group on the multi-function steering wheel, you can switch between the speed limiter, cruise control and distance control assistant driving systems.

You can activate/deactivate PPC and Attention Assist using the **Systems** menu window in the settings menu (▷ page 151). You can activate/deactivate Active Brake Assist and Lane Keeping Assist using the buttons on the dashboard.

Speed limiter





Important safety notes

The speed limiter is only an aid. You are responsible for the distance to the vehicle in front, for vehicle speed, braking in good time and remaining in lane. You should always adapt your driving style to suit prevailing road and weather conditions.

Also observe the warning notes of the other driving systems.

Overview



-  Selects the speed limiter
-  Activates and sets the current limit speed/increases the set limit speed
-  Activates and calls up the stored limit speed/decreases the set limit speed
-  Selects cruise control (▷ page 277)/sets the distance control assistant (▷ page 278)
-  Deactivates the speed limiter

The  symbol in the on-board computer shows the status of the speed limiter by colour:



- Grey symbol: the speed limiter is selected, but not activated.
- White symbol: the speed limiter is active and is restricting the vehicle speed to the set limit speed.

Activating

Functions and activation conditions

The speed limiter restricts the vehicle speed to the set limit speed. It is possible to accelerate the vehicle up to the set limit speed using the accelerator pedal. In order to keep the set limit speed on downhill gradients, the speed limiter automatically brakes the vehicle with the continuous brake. If the set speed is exceeded, the  symbol in the on-board computer flashes. If the speed limiter cannot be activated, the on-board computer will display - - - km/h in grey.



Selecting the speed limiter

- ▶ Press the  button.
The on-board computer shows the  symbol in grey.

Activating when driving



- ▶ Select the speed limiter.
- ▶ Drive at the desired speed and briefly press the  button.
The speed limiter is activated and the current vehicle speed is stored as the limit speed.

or

- ▶ Briefly press the  button.
The speed limiter is activated and assumes the stored limit speed.
The on-board computer shows the  symbol and the set limit speed in white.



Increasing/decreasing the limit speed

You can change the settings of the limit speed while driving.

- ▶ Activate the speed limiter.
- ▶ **To adjust in 1 km/h increments:** press the  or  button repeatedly until the

desired speed is shown in the on-board computer.

or

- ▶ **To adjust in 5 km/h increments:** press and hold the  or  button until the desired speed is shown in the on-board computer.



Driving

It is possible to exceed the set limit speed, e.g. when overtaking:



- ▶ Briefly depress the accelerator pedal beyond the point of resistance (kickdown). The set limit speed is still shown and the  symbol flashes in the on-board computer.
- ▶ When overtaking is completed, briefly release the accelerator pedal and depress it again. The speed limiter again restricts the vehicle speed to the set limit speed.

Deactivating

The limit speed remains stored if you deactivate the speed limiter.

- ▶ Press the  button. The on-board computer shows the  symbol in grey.

or

- ▶ Using the  button, select cruise control or the distance control assistant. The on-board computer shows the  or  symbol and the set speed in grey.

Cruise control

Important safety notes

WARNING

If you call up a stored speed and this is different from the current speed, the vehicle accelerates or brakes. If you do not know what the stored speed is, the vehicle may accelerate or brake unexpectedly. There is a risk of an accident.

Take the traffic conditions into account before calling up the stored speed. If you do not know what the stored speed is, store the desired speed again.

- ▶ **!** Do not exceed the maximum speed of the individual gears. Keep an eye on the rev counter.





If you fail to adapt your driving style or fail to pay attention to your surroundings, cruise control can neither reduce the risk of an accident nor override the laws of physics. Cruise control cannot take road and weather conditions into account, nor the prevailing traffic situation. Cruise control is only an aid. You are responsible for the distance to the vehicle in front, for vehicle speed, braking in good time and remaining in lane. You should always adapt your driving style to suit prevailing road and weather conditions.

Do not use cruise control:

- in traffic conditions that do not allow you to drive at a constant speed (e.g. heavy traffic or winding roads). You may otherwise cause an accident.
- on slippery roads. The drive wheels may lose their grip when braking or accelerating and the vehicle may skid.
- when there is low visibility, e.g. due to fog, heavy rain or snow.

Overview



-  Selects cruise control/sets the distance control assistant (▷ page 278)
-  Activates and adjusts current speed/ increases set speed
-  Activates and calls up stored speed/ reduces set speed
-  Selects the speed limiter (▷ page 275)
-  Deactivates cruise control

The  symbol in the on-board computer shows the status of cruise control in colour:

- grey symbol: cruise control is selected, but not activated
- white symbol: cruise control is activated and maintains the set speed

Engaging

Functions and activation conditions

Cruise control maintains the set speed of the vehicle for you. If the set speed is exceeded on downhill gradients by more than the set speed tolerance, the continuous brake is applied automatically.

If you are driving slower than 15 km/h, cruise control cannot be activated.



If cruise control cannot be activated, the on-board computer will display - - - km/h in grey.

Cruise control is deactivated automatically if:

- you are driving slower than 10 km/h
- the transmission is shifted into neutral for more than approximately 5 seconds

If cruise control is deactivated automatically, a warning tone sounds.



Selecting cruise control

- ▶ Press the  button repeatedly until the on-board computer shows the  symbol in grey.

Activating when driving

- ▶ Select cruise control.
- ▶ Drive at the desired speed and briefly press the  button. Cruise control is activated and the current speed is stored.



or

- ▶ Briefly press the  button. Cruise control is activated and assumes the stored speed. The on-board computer shows the  symbol and the set speed in white.
- ▶ Release the accelerator pedal. In order to maintain the set speed, cruise control automatically brakes or accelerates the vehicle.



Setting the speed and speed tolerance

Increasing/reducing the speed

You can change the speed setting while driving.

- ▶ Activate cruise control.
- ▶ **To adjust in 0.5 km/h increments:** press the  or  button repeatedly until the desired speed is shown in the on-board computer.

or

- ▶ **To adjust in 5 km/h increments:** press and hold the  or  button until the desired speed is shown in the on-board computer.

Setting the speed tolerance

Set the speed tolerance (▷ page 283).

Driving

Driving tips

Cruise control maintains the set speed more smoothly in the **A economy** and **A fleet** drive programs. For this reason, the driving speed and the set speed may differ slightly under certain circumstances. This leads to lower fuel consumption. In drive programs **A economy** and **A fleet**, the speed can be set to a maximum of 85 km/h. In drive program **A economy**, you can exceed the set speed by depressing the accelerator pedal, e.g. for overtaking.

You can decelerate using the continuous brake. Cruise control remains activated.

If you reset the continuous brake lever, but do not deactivate it, the vehicle will accelerate on inclines up to the set speed.

If the continuous brake is deactivated, the vehicle will accelerate to the last stored speed.

If cruise control is decelerating the vehicle using the continuous brake and you simultaneously depress the brake pedal, cruise control remains activated.

If the braking power from the continuous brake is insufficient:

- ▶ Shift down a gear and reduce your speed. If you shift down on a downhill gradient without adjusting the speed, cruise control sets an engine speed lower than the engine overspeed. The set speed remains set and is automatically re-established as soon as this is possible in a higher gear.

The vehicle is braked by the continuous brake automatically if:

- cruise control is activated and
- the vehicle speed exceeds the set speed by more than the upper speed tolerance

When the continuous brake is activated and you activate cruise control, the continuous brake regulates the set speed on downhill slopes.

Overtaking

It is possible to exceed the set speed, e.g. when overtaking:

- ▶ Depress the accelerator pedal.
- ▶ When the overtaking manoeuvre is finished, release the accelerator pedal again.
Cruise control adjusts the vehicle's speed to the set speed.

Disengaging



The speed remains stored if you deactivate cruise control.

- ▶ Press the  button.



or

- ▶ When cruise control accelerates the vehicle, depress the brake pedal.
The on-board computer shows the  symbol and the set speed in grey.

or

- ▶ Select the speed limiter with the  button.
The on-board computer shows the  symbol in grey.

or

- ▶ Select the distance control assistant with the  button.
The on-board computer shows the  symbol and the set speed in white. The distance control assistant is activated (▷ page 280).

Distance control assistant

Important safety notes

WARNING

Distance control assistant does not respond to:

- people or animals
- stationary obstacles on the road, e.g. stopping or parking vehicles
- oncoming vehicles and crossing traffic

As a result, the distance control assistant may not warn you or intervene in these situations. There is a risk of an accident.

Always pay careful attention to the traffic situation and be ready to brake.

WARNING

The distance control assistant cannot always clearly identify other road users and complex traffic situations.

In such cases, the distance control assistant can:

- accelerate or brake the vehicle unexpectedly
- intervene unexpectedly

There is a risk of an accident.

Continue to drive carefully and be ready to brake, especially if the distance control assistant warns you.

WARNING

The distance control assistant brakes your vehicle with up to 30% of the maximum possible deceleration. There is a risk of an accident.

In these cases, apply the brakes yourself and try to take evasive action.

Observe the safety warnings detailing situations in which vehicles in front may not be detected correctly (▷ page 287):

The distance control assistant may not detect narrow vehicles driving in front, e.g. motorcycles, and vehicles driving on a different line.

In particular, be aware of the following driving situations:

- cornering, entering and exiting bends
- your own vehicle driving on a different line or vehicles in front of you driving on a different line
- other vehicles changing lane
- vehicles turning off
- overtaking
- winding stretches of road
- obstacles and stationary vehicles

Clean the distance sensor of the distance control assistant regularly (▷ page 352).

If you fail to adapt your driving style or if you are inattentive, the distance control assistant can neither reduce the risk of an accident nor override the laws of physics. The distance control assistant cannot take the road and weather conditions into account, nor the prevailing traffic situation. The distance control assistant is only an aid. You are responsible for the distance to the vehicle in front, for vehicle speed, braking in good time and remaining in lane.





Do not use the distance control assistant:

- on slippery roads. The drive wheels may lose their grip when braking or accelerating and the vehicle may skid.
- when there is low visibility, e.g. due to fog, heavy rain or snow.

If the distance control assistant no longer detects a vehicle driving in front, the distance control assistant may accelerate to the stored speed. On a filter lane or a slip road, this speed may be too high.

Overview



-  Selects cruise control/sets the distance control assistant (▷ page 276)
-  Activates and adjusts current speed/increases set speed
-  Activates and calls up stored speed/reduces set speed
-  Selects the speed limiter (▷ page 275)
-  Deactivates the distance control assistant

The  symbol in the on-board computer shows the status of the distance control assistant by colour:

- grey symbol: the distance control assistant is selected, but not activated
 - white symbol: the distance control assistant is activated, but a vehicle in front has not been detected
 - white symbol with a blue vehicle inside the symbol: the distance control assistant is activated and a vehicle in front has been detected
- When a vehicle has been detected up ahead, the on-board computer also displays its speed and the distance to the detected vehicle.

i The **Assistance** menu window also displays the speed of the detected vehicle and the distance to the detected vehicle in the  driving menu (▷ page 139).

Activating

Functions and activation conditions

The distance control assistant controls the speed and supports you in automatically maintaining the distance from a vehicle detected in front. If there is no vehicle in front, the distance control assistant operates in the same way as cruise control in the speed range between 15

and 90 km/h. If a vehicle is detected in front, it operates in the speed range between 0 and 90 km/h.

If the distance control assistant detects a vehicle in front driving at a slower speed, your vehicle is slowed and the specified minimum distance selected by you is maintained.

The distance control assistant brakes the vehicle with the continuous brake if:

- the vehicle exceeds the set speed, including the set speed tolerance, e.g. on a downhill gradient
- a slower vehicle in front is detected

When the continuous brake slows the vehicle, the  indicator lamp lights up in the instrument cluster.

The distance control assistant may also brake the vehicle using the service brake in order to maintain the specified minimum distance. If the vehicle in front is no longer detected, e.g. if it changes lane, your vehicle will accelerate up to the set speed.

The distance control assistant cannot be activated or is deactivated automatically if:

- you are driving slower than 15 km/h on roads with more than a 10% downhill/uphill gradient
- you are driving slower than 5 km/h and a vehicle in front is not detected
- you shift the transmission into neutral for more than approximately 5 seconds
- you select the reverse gear
- you deactivate ABS
- the vehicle is stationary and you leave your seat
- the vehicle is stationary and you open the driver's door
- for vehicles with air suspension, the chassis is not within the driving level
- there is a malfunction in the brake system/electronic management system
- the distance sensor initialisation is not yet complete

If the distance control assistant is deactivated automatically, a warning tone sounds.



If the distance control assistant cannot be activated, the on-board computer will display - - - km/h in grey.

The distance control assistant remains activated if:

- you decelerate using the continuous brake
- it decelerates the vehicle using the continuous brake/service brake and you simultaneously depress the brake pedal

If your vehicle accelerates and you depress the brake pedal, the distance control assistant is deactivated automatically.

Selecting the distance control assistant

- ▶ Press the  button repeatedly until the on-board computer shows the  symbol in grey.



If you change from cruise control to the distance control assistant and the distance control assistant was activated earlier, the  symbol appears in white in the on-board display. The distance control assistant is activated. The vehicle adapts its speed to that of the vehicle in front, but only up to the desired and set speed.

Activating when driving

At speeds below 15 km/h, you can only activate the distance control assistant if a vehicle in front has been detected.



- ▶ Drive at a speed above 15 km/h.
- ▶ Select the distance control assistant.
- ▶ Briefly press the  button. The distance control assistant is activated and the current speed is set.

or

- ▶ Briefly press the  button. The distance control assistant is activated and the last stored speed is set. The on-board computer shows the  symbol and the set speed in white.
- ▶ Release the accelerator pedal. The vehicle adapts its speed to that of the vehicle in front, but only up to the desired and set speed.

Activating while the vehicle is stationary

When the vehicle is stationary, only activate the distance control assistant in a traffic jam on roads similar to motorways and not in urban traffic. The function is not designed for urban traffic. When the vehicle is stationary, you can only activate the distance control assistant if a vehicle in front has been detected.

- ▶ Apply the parking brake or the service brake.
- ▶ Select the distance control assistant.
- ▶ Briefly press the  button. The distance control assistant is activated and the last stored speed is set. The on-board computer shows the  symbol and the set speed in white.
- ▶ Release the parking brake or service brake. The distance control assistant prevents the vehicle from rolling away.

The on-board computer shows the "Apply parking brake" event window when the vehicle is stationary, the distance control assistant is activated and you:

- leave the driver's seat
- open the driver's door
- switch off the engine

Pulling away and stopping the vehicle

Pulling away

The distance control assistant's starting-off function provides support when driving in traffic jams. Your vehicle pulls away automatically after a standstill within 2 seconds if the vehicle in front drives on.

In order that the vehicle can pull away automatically, the following conditions must be fulfilled:

- the vehicle in front of you drives on or is already more than 10 m away
- a forward gear is engaged
- the continuous brake is deactivated
- the parking brake and service brake are released
- ▶ To pull away, briefly depress the accelerator pedal.

or

- ▶ Press the  button. The vehicle pulls away and adapts its speed to that of the vehicle in front, but only up to the desired and set speed.

To pull away on vehicles with a hydrodynamic clutch, you must depress the accelerator pedal permanently in order to complete the pulling away procedure.

Stopping

WARNING

If you leave the driver's seat, although the vehicle is only being braked by the distance control assistant, it can roll away if:

- there is a malfunction in the system or in the voltage supply
- distance control assistant is deactivated, e.g. by a vehicle occupant or from outside of the vehicle
- the accelerator pedal is depressed, e.g. by a vehicle occupant
- the  button is pressed, e.g. by a vehicle occupant

There is a risk of an accident.



If you wish to leave the driver's seat, always deactivate the distance control assistant and secure the vehicle against rolling away.

If the distance control assistant detects that the vehicle in front has stopped, it will brake your vehicle to a stop. Depending on the specified minimum distance, your vehicle will come to a halt within an appropriate distance from the vehicle in front.



Setting the speed and speed tolerance/ specified minimum distance

Increasing/reducing the speed

You can only change the speed setting while driving.

- ▶ Activate the distance control assistant.
- ▶ **In 0.5 km/h increments:** press the  or  button repeatedly until the desired speed is shown in the on-board computer.

or





- ▶ **To adjust in 5 km/h increments:** press and hold the  or  button until the desired speed is shown in the on-board computer.

Setting a specified distance to the vehicle in front



The minimum distance for the distance control assistant can be set to 5 levels. If you restart the engine, the mean specified distance is available for selection.

Make sure that you maintain the minimum distance to the vehicle in front required by law. Adjust the specified minimum distance to the vehicle in front if necessary.

- ▶ Press the  button repeatedly until the **ACC distance** input window appears in the on-board computer.
 - ▶ Press the  or  button to reduce or to increase the specified minimum distance. The bar display shows the specified minimum distance you have selected.
 - ▶ Press the  button to exit the input window.
- or
- ▶ Wait for approximately 3 seconds. The setting is stored automatically.

Setting the speed tolerance

Set the speed tolerance (▷ page 283).







Driving

It is possible to exceed the set speed, e.g. when overtaking:

- ▶ Maintain a sufficient distance to the vehicle in front.
- ▶ Depress the accelerator pedal.
- ▶ When the overtaking manoeuvre is finished, release the accelerator pedal again. The distance control assistant adjusts the speed to the set speed.

Deactivating

The speed remains stored if you deactivate the distance control assistant.

- ▶ Press the  button.
- or
- ▶ When the distance control assistant accelerates the vehicle, depress the brake pedal. The on-board computer shows the  symbol and the set speed in grey.
- or
- ▶ Select the speed limiter with the  button. The on-board computer shows the  symbol in grey.
- or
- ▶ Select cruise control with the  button. The on-board computer shows the  symbol and the set speed in white. Cruise control is activated (▷ page 277).

Observe the conditions that lead to automatic deactivation of the distance control assistant (▷ page 279).

PPC (Predictive Powertrain Control)



Example: speed tolerances display

PPC uses topographic map data to optimise fuel consumption and to adjust output according to operating conditions. PPC influences gear selection and adjusts the speed of cruise control or distance control assistant. The speed adjustment facilitates better utilisation of momentum accumulated on downhill gradients. On uphill gradients, the power output is optimised and may be reduced before the top of the hill is reached. You can adjust the speed tolerances in the **Eco-Drive** menu window (▷ page 283).



PPC is active if:

- it has been activated in the settings menu
- cruise control or the distance control assistant is active
- GPS reception is available
- map data is available

PPC is limited if:

- you set the speed in cruise control or the distance control assistant
- you set the speed tolerance
- the transmission is in the manual drive program
- you depress the accelerator or brake pedal
- the continuous brake is active
- the distance control assistant brakes the vehicle

The on-board computer shows the status of PPC by colour:

- Grey symbol : cruise control is deactivated.
- White symbol  with **PPC**: PPC is activated and cruise control is active.
- Green symbol  with **PPC**: PPC actively regulates the speed and gear selection in cruise control or for the distance control assistant.

PPC can be deactivated and activated using the **Systems** menu window in the  settings menu (▷ page 151).

Speed tolerance in the driving systems

Overview



Example: display with PPC

Speed tolerance lets you determine the extent to which the vehicle speed is allowed to fall below/exceed the set speeds of various driving systems.

Upper speed tolerance

The  upper speed tolerance helps to better utilise momentum from downhill gradients and thus save fuel. The upper speed tolerance operates on the cruise control, distance control assistant and PPC driving systems.

For all drive programs except **A economy** and **A fleet**, you can set the upper speed tolerance between 2 and 15 km/h. In the **A economy** and **A fleet** drive programs, the setting can only be adjusted to between 4 and 15 km/h. If you set the upper speed tolerance to between 4 and 15 km/h, the value remains saved even after you restart the engine.

The on-board computer shows the upper speed tolerance next to the set speed. When cruise control or distance control assistant is activa-

ted, the speed limiter brakes the vehicle by 4 km/h by applying the continuous brake.











Lower speed tolerance

The  lower speed tolerance can be set on vehicles with PPC. By reducing power output at the top of a hill at the correct time, the lower speed tolerance helps save fuel.

For all drive programs except **A economy** and **A fleet**, you can set the upper speed tolerance between 0 and 10 km/h. In the **A economy** and **A fleet** drive programs, the setting can only be adjusted to between 3 and 10 km/h.

When PPC is active, the on-board computer shows the lower speed tolerance next to the speed.

Setting the speed tolerance

- ▶ Press the  button repeatedly until **Eco Drive** is displayed in the input window.
 - ▶ With the  or  button, select the  or  menu bar. In the  menu bar, set the value by which the stored speed may be exceeded. In the  menu bar, set the value by which the stored speed may be fallen short of.
 - ▶  To optimize consumption, PPC can affect the speed tolerances:
 - by falling below the speed tolerance by a few km/h
 - or
 - in the drive programs **A economy** and **A fleet**, by briefly exceeding the speed tolerance by a maximum of 4 km/h
 - by briefly exceeding the speed tolerance in all other drive programs by a maximum of 1 km/h
 - ▶ Press the  or  button to increase/decrease speed tolerance in 1 km/h increments.
 - ▶ Press the  button to exit the input window.
- or
- ▶ Wait for approximately 3 seconds. The setting is stored automatically.

Active Brake Assist

Important safety notes

The term, Active Brake Assist, used in the following sections applies to Active Brake Assist 4.

WARNING

Active Brake Assist with cross-traffic function will initially brake your vehicle by a partial application of the brakes if a danger of collision is detected. There may be a collision unless you brake yourself. Even after subsequent full application of the brakes a collision cannot always be avoided, particularly when approaching at too high a speed. There is a risk of an accident.

Always apply the brakes yourself and try to take evasive action, provided it is safe to do so.

WARNING

Active Brake Assist cannot always recognise other road users and complex traffic conditions.

In such cases, Active Brake Assist may:

- give an unnecessary warning and then brake the vehicle
- neither give a warning nor intervene

There is a risk of an accident.

Continue to drive carefully and be prepared to brake, particularly if Active Brake Assist warns you.

WARNING

Active Brake Assist does not react to:

- animals
- oncoming vehicles

As a result, Active Brake Assist might not warn you or intervene in these situations. There is a risk of an accident.

Always pay careful attention to the traffic situation and be ready to brake.

If Active Brake Assist detects the risk of a collision with the vehicle in front, it issues an audible and visual warning. If you do not react and the

risk persists, Active Brake Assist automatically initiates partial braking of the vehicle. If you do not react to the partial brake application, Active Brake Assist automatically initiates an emergency braking manoeuvre.

Active Brake Assist assists you:

- in ideally avoiding a collision with the vehicle in front
- in minimising the danger of a collision with the vehicle in front or a stationary obstacle in the path of your vehicle
- in reducing the consequences of a collision with the vehicle in front

Within the system boundaries, Active Brake Assist can:

- react earlier to an obstacle in the path of your vehicle
- react to moving people with a warning and partial brake application
- perform an emergency braking manoeuvre at higher speeds as a full brake application to bring the vehicle to a standstill

If you fail to adapt your driving style or if you are inattentive, Active Brake Assist can neither reduce the risk of an accident nor override the laws of physics.

You are responsible for keeping a safe distance to the vehicle in front, for the vehicle speed, braking in good time and remaining in lane. You should always adapt your driving style to suit prevailing road and weather conditions.

Brake the vehicle using the service brake if:

- a red event window with the  symbol appears in the on-board computer
- an intermittent warning tone sounds
- an intermittent warning tone sounds and automatic partial braking was initiated

Active Brake Assist may not detect narrow vehicles driving in front, e.g. motorcycles or vehicles driving on a different line.

Read the safety notes on driving conditions that may lead to system restrictions (▷ page 287).

The system may not react correctly:

- to stationary people
- to people or vehicles moving quickly within the detection range of the sensors
- to people in a tunnel

Active Brake Assist may unexpectedly issue warnings or brake your vehicle:

- in car washes
- to stationary obstacles inside a tunnel
- on ferries
- in loading areas
- at tollgates
- in workshops

If no visual and/or acoustic warning is issued in a critical situation:

- Active Brake Assist has not recognised the danger of the situation
- Active Brake Assist is deactivated
- Active Brake Assist has failed

If a visual and/or acoustic warning is issued or a partial braking manoeuvre is performed in a non-critical situation:

- suppress Active Brake Assist or
- press the  button to deactivate Active Brake Assist

You can suppress or deactivate Active Brake Assist if you:

- use a turn signal
- depress the accelerator pedal
- press the Active Brake Assist OFF button

You can cancel an emergency braking manoeuvre triggered by Active Brake Assist, if you:

- depress the accelerator pedal beyond the pressure point (kickdown)
- or press the Active Brake Assist OFF button

Clean the cover of the Active Brake Assist distance sensor regularly (▷ page 352).

If the distance sensor cover is dirty or icy, its functionality may be impaired.





Do not mount any attachments in front of the distance sensor, e.g. a crash guard, and do not paint or affix items to the sensor cover. Otherwise, the operation of the distance sensor and the operation of Active Brake Assist may be affected.

Activating and deactivating Active Brake Assist



When you start the engine, Active Brake Assist is automatically activated.

Active Brake Assist is deactivated automatically if:

- there is a malfunction
 - ABS is deactivated or there is a malfunction in the brake system of the vehicle
- **To deactivate:** press the  button. When the  indicator lamp in the instrument cluster lights up, Active Brake Assist is deactivated.
- **To activate:** press the  button for approximately 1 second. When the  indicator lamp in the instrument cluster goes out, Active Brake Assist is activated.

Collision warning and emergency braking

Overview

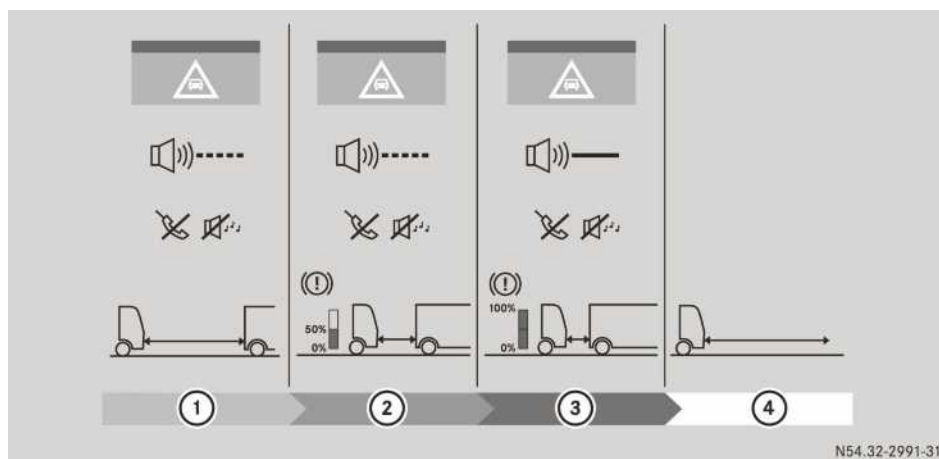

- ① Active Brake Assist warning
- ② Active Brake Assist partial braking
- ③ Emergency stop (full brake application)
- ④ Emergency stop completed

If a collision warning appears in the on-board computer when the vehicle is in motion:

- Pay particular attention to the traffic situation.
- Depress the brake pedal.

If there is a risk of a collision with the vehicle in front and Active Brake Assist issues a warning, the audio device and/or hands-free system installed at the factory are automatically muted.

Warning (Active Brake Assist)

The  symbol appears in the red event window in the on-board computer. An intermittent warning tone sounds.

Partial braking (Active Brake Assist)

The  symbol appears in the red event window in the on-board computer. An intermittent warning tone sounds. In addition, Active Brake Assist slows the vehicle with automatic partial braking. Active Brake Assist brakes the vehicle with around 50% of the vehicle's maximum braking power.

Emergency braking (Active Brake Assist)

If you do not react to the collision warnings and partial brake application, Active Brake Assist automatically initiates emergency braking (full brake application) within the system boundaries. During brake application, rapid flashing of the hazard warning lamps (emergency braking flashing) is activated to warn following traffic.

The  symbol appears in the red event window in the on-board computer. A continuous warning tone sounds. In addition, Active Brake Assist slows the vehicle with an automatic emergency braking manoeuvre (full brake application).

After emergency braking procedure has been performed, the **Emergency braking finished** message appears in the grey event window in the on-board computer. The hazard warning lamps automatically change to slow flashing.

After emergency braking to at standstill, the vehicle is held by the service brake for another 5 seconds to prevent it from rolling away.

If an emergency braking manoeuvre has been performed:

- ▶ Remove the vehicle from the area of danger as soon as possible while paying attention to the traffic situation.
- ▶ Stop the engine and apply the parking brake to prevent the vehicle from rolling away.
- ▶ Make sure that the vehicle is in proper operating order and that the load is secured properly.

You can interrupt emergency braking as follows:

- ▶ Press the  button.

or

- ▶ Depress the accelerator pedal beyond the point of resistance (kickdown).

Particular driving situations

Cornering, entering and exiting bends

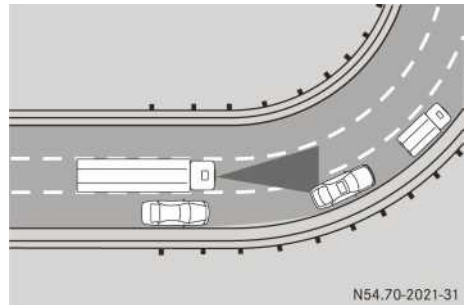

The ability of Active Brake Assist and the distance control assistant to detect vehicles on bends is limited. Active Brake Assist and the distance control assistant may unexpectedly issue warnings or brake your vehicle. The distance control assistant may also accelerate the vehicle unexpectedly.

Driving on a different line and stationary vehicles

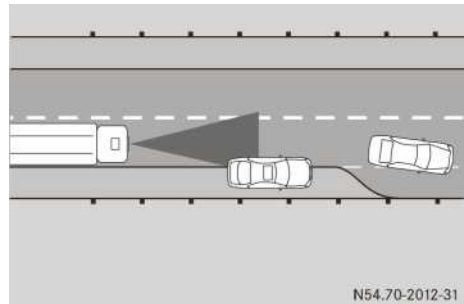

The ability of Active Brake Assist and the distance control assistant to detect vehicles driving on a different line or stationary vehicles is limited. Active Brake Assist and the distance control assistant may unexpectedly issue warnings or brake your vehicle. The distance control assistant may accelerate unexpectedly.

Other vehicles changing lane

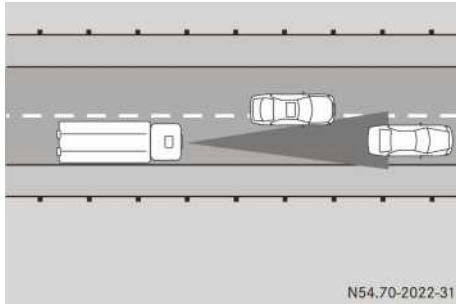

The ability of Active Brake Assist and the distance control assistant to detect vehicles pulling into your lane is limited. The distance to the vehicle in front entering your lane may then be too short. Active Brake Assist and the distance control assistant may unexpectedly issue warnings or brake your vehicle. The distance control assistant may also accelerate the vehicle unexpectedly.

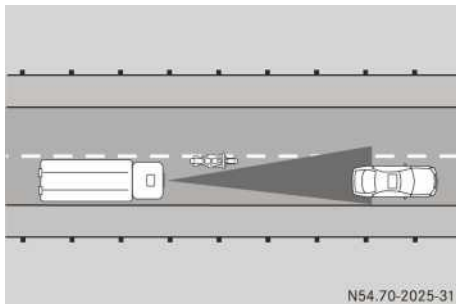

The ability of Active Brake Assist and the distance control assistant to detect vehicles pulling into your lane without maintaining a safe distance is limited. Only once vehicles are within the system's detection range will they be detected. The distance control assistant may accelerate unexpectedly. Brake the vehicle. This will increase the distance to the vehicle in front.

Vehicles turning off

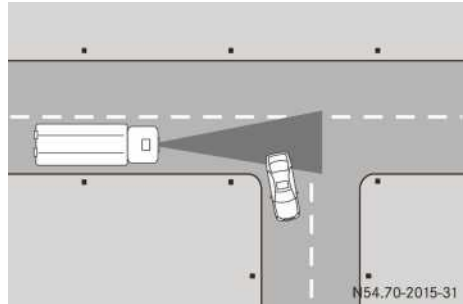

The ability of Active Brake Assist and the distance control assistant to detect vehicles turning off is limited. Active Brake Assist and the distance control assistant may unexpectedly issue warnings or brake your vehicle.

Overtaking

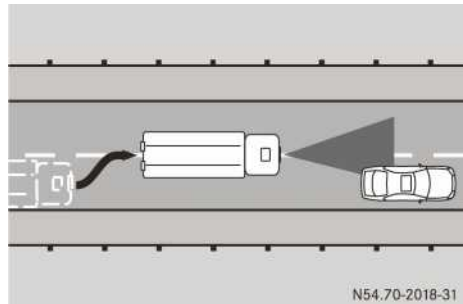

When you are overtaking, Active Brake Assist and the distance control assistant may unexpectedly issue warnings or brake your vehicle if you:

- drive too close to the vehicle in front and
- are in the same lane as the vehicle in front

Winding stretches of road

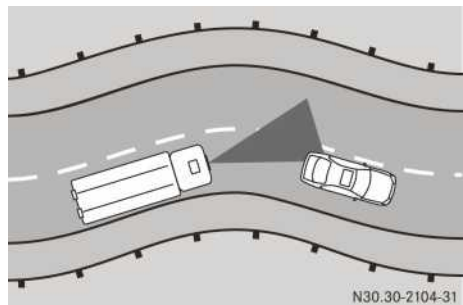

On winding stretches of road, Active Brake Assist and the distance control assistant cannot detect which lane the vehicle in front is driving in. Active Brake Assist and the distance control assistant may unexpectedly issue warnings or brake your vehicle. The distance control assistant may also accelerate the vehicle unexpectedly.

Obstacles and stationary vehicles

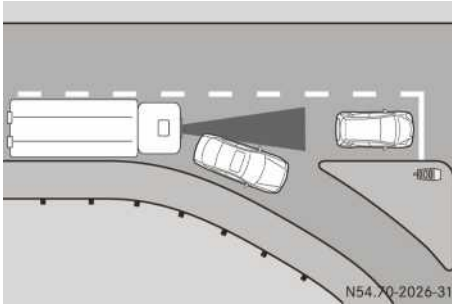

Active Brake Assist and the distance control assistant cannot detect obstacles or stationary vehicles in front of the detected vehicle. Active Brake Assist and the distance control assistant may unexpectedly issue warnings or brake your vehicle. The distance control assistant may also accelerate the vehicle unexpectedly.

Stationary objects

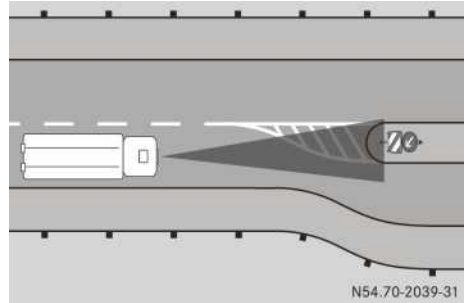
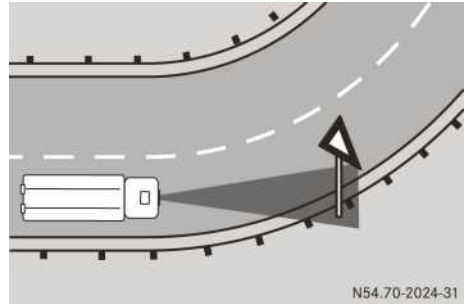

Active Brake Assist can also unexpectedly issue warnings and brake the vehicle if it detects stationary objects next to your lane, e.g.:

- vehicles which have broken down
- signs
- bridges
- traffic islands

People

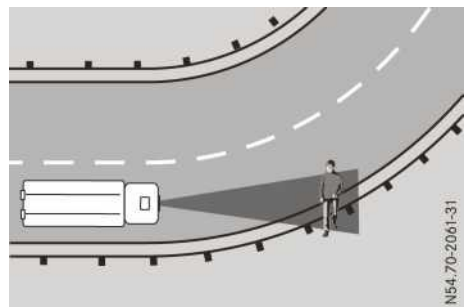

Active Brake Assist may also unexpectedly issue a warning or brake for people at the roadside in a corner.

Lane Keeping Assist

Important safety notes

WARNING

Lane Keeping Assist cannot always clearly identify lane markings.

In these cases, Lane Keeping Assist may:

- give an unnecessary warning
- not give a warning

There is a risk of an accident.

Always pay particular attention to the traffic situation and keep in lane, especially if Lane Keeping Assist alerts you.

The system may be impaired or may not operate:

- if there is low visibility, e.g. due to insufficient road illumination or due to snow, rain, fog or heavy spray
- if there is glare, e.g. from oncoming traffic, the sun or reflection from other vehicles (e.g. if the road surface is wet)
- if the windscreen is dirty, misted up, damaged or covered, for instance by a sticker, in the vicinity of the camera
- if no or several, unclear lane markings are present for one lane, e.g. in a construction area
- if the lane markings are worn away, dark or covered up, e.g. by dirt or snow
- if the distance to the vehicle in front is too small and the lane markings thus cannot be detected
- if the lane markings change quickly, e.g. lanes branch off, cross one another or merge
- if the road is narrow and winding
- if there are highly variable shade conditions on the road surface
- if attachments, e.g. a snow plough, restrict the camera's view of the road lane markings.
- after a significant change in load with the ignition switched on. Therefore, start the engine again after a significant change in load for Lane Keeping Assist to be available without any restrictions.

If you fail to adapt your driving style, Lane Keeping Assist can neither reduce the risk of accident nor override the laws of physics. Lane Keeping Assist cannot take the road and weather condi-

tions into account, nor the prevailing traffic situation. Lane Keeping Assist is only an aid. You are responsible for the distance to the vehicle in front, for vehicle speed, braking in good time and remaining in lane.

Make sure that the windscreen is always kept clean and unobstructed in the area of the camera (▷ page 352). You can switch on the windscreen wiper to clean the windscreen, for example, or remove snow and ice from the windscreen.

Overview



Lane Keeping Assist button and display

i The lane markings are also displayed in the **Assistance** menu window in the **VR** driving mode menu (▷ page 139).

The lane markings in the status area and in the Assistance menu window of the on-board computer show the status of Lane Keeping Assist in colour:

- Black lane markings: Lane Keeping Assist is deactivated.
- Grey lane markings: Lane Keeping Assist is activated but not ready to issue warnings on the side of the vehicle in question.
- White lane markings: Lane Keeping Assist is activated and ready to issue warnings on the side of the vehicle in question.
- Red lane markings: Lane Keeping Assist is activated and is issuing a warning on the side of the vehicle in question.

Functions and activation conditions

Lane Keeping Assist monitors the area in front of your vehicle with a camera that is on the base of the windscreen. When Lane Keeping Assist is activated and it detects lane markings on the

road surface, it warns you that you may be leaving your lane unintentionally.

Lane Keeping Assist is ready to issue warnings:

- above approximately 60 km/h
- when the lane markings appear in white in the on-board computer

When you drive over the lane marking unintentionally:

- the relevant lane marking is shown in red in the on-board computer
- the volume of the audio equipment and/or hands-free system is reduced and a warning tone sounds from the loudspeaker on the corresponding side of the vehicle

If the vehicle is not fully within the lane markings after a warning has been issued, no further warnings are possible.

Lane Keeping Assist does not issue a warning if:

- you have switched on the turn signals
- you clearly and actively steer, brake or accelerate
- a driving safety system intervenes, e.g. Active Brake Assist, Stability Control Assist or the distance control assistant

The warnings are then suppressed for a certain time period.

Lane Keeping Assist will warn you when changing lane if a turn signal has been switched on for more than 1 minute.

Deactivating/activating

When you start the engine, Lane Keeping Assist is automatically activated.

- ▶ Press the  button.

If Lane Keeping Assist is deactivated, the indicator lamp in the  button lights up. The lane marking appears black in the status area of the on-board computer and in the **Assistance** menu window of the on-board computer.

Attention Assist

Important safety notes

ATTENTION ASSIST is only an aid. ATTENTION ASSIST cannot always detect fatigue or lapses in concentration reliably or in time. ATTENTION

ASSIST is not a substitute for a well-rested and attentive driver.

ATTENTION ASSIST may be impaired or inoperative:

- if there is low visibility, e.g. due to insufficient road illumination or due to snow, rain, fog or heavy spray
- if the windscreen is dirty in the area of the camera, misted up, damaged or covered, e.g. by a sticker
- if no lane markings or several ambiguous lane markings are present for a lane, e.g. near construction sites
- if the lane markings are worn, dark or covered, for example by dirt or snow
- if there is glare, e.g. due to oncoming traffic, direct sunlight or reflections (e.g. from wet road surfaces)
- on winding roads
- the distance to the vehicle in front is too small and the lane markings thus can often not be detected
- if attachments, e.g. a snow plough, restrict the camera's view of the road lane markings
- after a significant change in load with the ignition switched on. Therefore, start the engine again after a significant change in load for ATTENTION ASSIST to be available without any restrictions.

Make sure that the windscreen is always kept clean and unobstructed in the area of the camera (> page 352). You can switch on the windscreen wiper to clean the windscreen, for example, or you can remove snow and ice from the windscreen.

Overview

ATTENTION ASSIST assists you during long, monotonous journeys, such as on motorways and trunk roads. ATTENTION ASSIST is active at speeds above approximately 60 km/h.

If ATTENTION ASSIST detects typical indicators of fatigue or increasing lapses in concentration on the part of the driver, it suggests taking a break. A warning is shown by ATTENTION ASSIST irrespective of legally prescribed driving and rest periods or digital tachograph functions.

Functions and activation conditions

ATTENTION ASSIST assesses your level of fatigue or lapses in concentration by taking the following criteria into account:

- personal driving style, e.g. remaining in lane, steering characteristics
- journey-related parameters, e.g. length of journey

ATTENTION ASSIST is restricted and a warning does not occur or is delayed:

- if you are predominantly driving slower than 60 km/h
- if the markings on the road are missing or difficult to distinguish
- on winding roads

If ATTENTION ASSIST detects typical indicators of fatigue or increasing lapses in concentration on the part of the driver:

- a warning tone sounds
- the on-board computer shows the yellow  event window and **ATTENTION ASSIST: take a break?**
- Lane Keeping Assist is reactivated automatically

During long journeys, take regular breaks in good time. If you do not take a break, ATTENTION ASSIST can only warn you again after 15 minutes at the earliest.

When you switch off the engine or the vehicle is stationary for some time, ATTENTION ASSIST resets the detection sequence.

Deactivating/activating

After starting the engine, ATTENTION ASSIST is always activated. You can deactivate/activate ATTENTION ASSIST using the **Systems** menu window in the settings menu (▷ page 151).

Sideguard Assist

General notes

Sideguard Assist is only available on left-hand drive vehicles. Sideguard Assist monitors the area to the right of the tractor vehicle and trailer/semitrailer using two radar sensors. The radar sensors are mounted to the right-hand wing bracket in front of the rear axle. Sideguard Assist provides assistance when turning right

and changing into the right-hand lane. A warning lamp in the warning element on the right-hand A-pillar informs you that an object has been detected in the monitored area. A warning tone also sounds if there is a risk of collision.

Sideguard Assist is not active while reversing. The trailer monitoring of Sideguard Assist is not active:

- shortly after reversing
 - shortly after coupling up
- It is not possible to switch the trailer monitoring of Sideguard Assist on or off:
- shortly after reversing
 - shortly after coupling up

Important safety notes

WARNING

When detection is restricted, Sideguard Assist may issue a warning too late or not at all.

In particular, the detection of obstacles can be impaired in the following situations:

- dirty, icy or obscured sensors
- very wide lanes
- vehicles not driving in the middle of their lane
- barriers or other road boundaries

There is a risk of an accident.

Always pay careful attention to the traffic situation and maintain a safe distance at the side of the vehicle.

Sideguard Assist is only an aid. It may fail to detect some objects and is not a substitute for attentive driving. Always ensure that there is sufficient distance to the side for other road users, pedestrians and obstacles.

Make sure that the area to the right next to the towing vehicle and the trailer/semitrailer is free before you turn right.

Monitoring range of the sensors

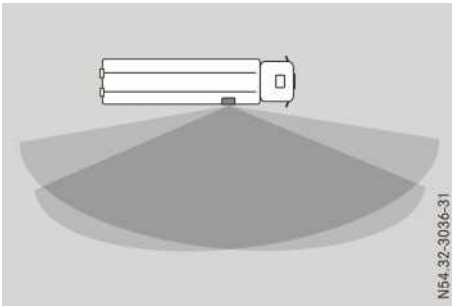

N54.3Z-3036-31

Monitoring range of the sensors

Between the vehicle and the monitoring range there is an angle of approximately 6° . Objects within this range are not detected.

Due to the nature of the system:

- warnings may be issued in error when driving close to crash barriers or similar solid boundaries
- warnings may be interrupted when you are driving alongside particularly long vehicles, such as lorries, for a prolonged time

Depending on the situation and on the trailer/semitrailer, Sideguard Assist may:

- issue a warning prematurely
- not issue a warning

Make sure that the radar sensor cover is free from dirt, ice or slush. The radar sensors must not be painted or covered, e.g. by stickers or films.

If Sideguard Assist is malfunctioning, the on-board computer displays a yellow event window. Objects in the monitoring range are then not indicated.

Have the function of the radar sensors checked at a qualified specialist workshop following:



- a severe impact
- damage to the right-hand side trim

Sideguard Assist may otherwise not work properly.

Indicator and warning lamp

Sideguard Assist is active when you switch on the ignition.

If you have coupled up a trailer/semitrailer, the grey  indicator lamp lights up in the

Assistance menu window of the on-board computer. If you have not coupled up a trailer/semitrailer, the grey  indicator lamp lights up in the Assistance menu window of the on-board computer. If you have switched off the trailer monitoring of Sideguard Assist, the grey  indicator lamp lights up in the Assistance menu window of the on-board computer.

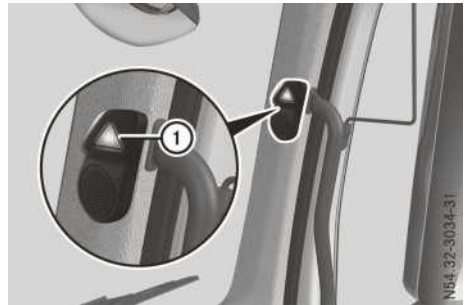

N54.3Z-3034-31

① Warning lamp in the A-pillar

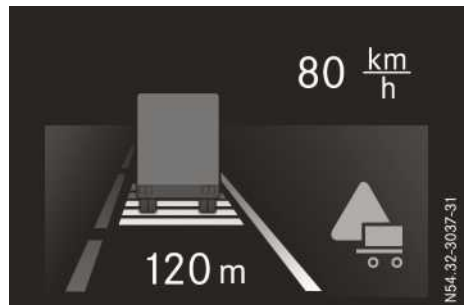

N54.3Z-3037-31

Example: assistance menu window

Warning when turning right

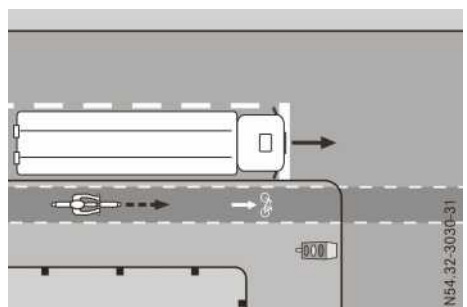

N54.3Z-3030-31

There is a moving object in the monitoring range of Sideguard Assist. The yellow warning lamp in

the A-pillar lights up. In addition, the indicator lamp lights up yellow in the **Assistance** menu window of the on-board computer.

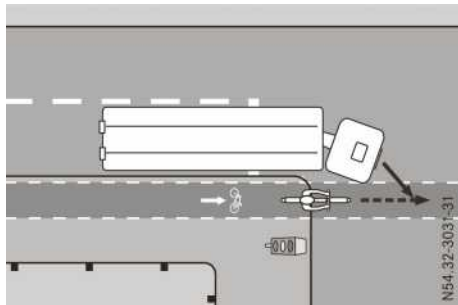

There is a moving object in the monitoring range of Sideguard Assist. Sideguard Assist recognises when you steer or indicate to the right and set the vehicle in motion. There is a risk of collision. The red warning lamp in the A-pillar flashes for approximately 2 seconds. A warning tone also sounds. The red warning lamp in the A-pillar then lights up continuously while there is a

risk of collision. In addition, the indicator lamp lights up red in the **Assistance** menu window of the on-board computer.

Warning when changing lanes

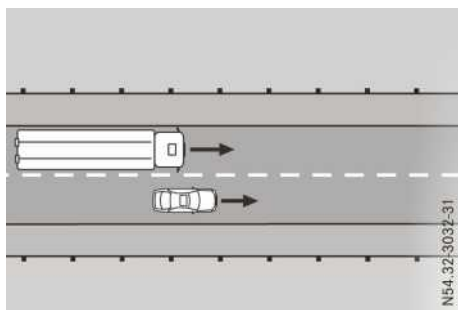

There is a moving object in the monitoring range of Sideguard Assist. The yellow warning lamp in

the A-pillar lights up. In addition, the indicator lamp lights up yellow in the **Assistance** menu window of the on-board computer.

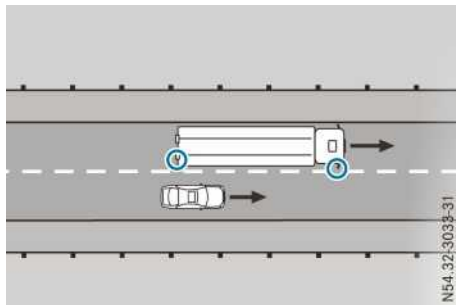

When changing lane, a moving object is located in the danger zone. There is a risk of collision.

If you indicate or steer to the right, the red warning lamp in the A-pillar flashes for approximately 2 seconds. A warning tone also sounds. The red warning lamp in the A-pillar then lights up continuously while there is a risk of collision. In

addition, the indicator lamp lights up red in the **Assistance** menu window of the on-board computer.

Warning for stationary obstacles when turning right

Sideguard Assist warns you about stationary obstacles in the vehicle's range of movement up to a maximum speed of 35 km/h.

Sideguard Assist is only an aid. It may fail to detect some objects and is not a substitute for attentive driving. Always ensure that there is sufficient distance to the side for other road users, pedestrians and obstacles.









If there is a risk of collision with a stationary obstacle when turning right, the red warning lamp in the A-pillar flashes for approximately 2 seconds. A warning tone also sounds. The red warning lamp in the A-pillar then lights up continuously while there is a risk of collision. In

addition, the indicator lamp lights up red in the **Assistance** menu window of the on-board computer.

Deactivating













Sideguard Assist is automatically activated when you switch on the ignition.

You can deactivate Sideguard Assist via the systems menu window.

- ▶ Use the  or  button to scroll to  settings.
- ▶ Use the  or  button to scroll to the **Systems** menu window.
- ▶ Press the  button.
- ▶ Use the  or  button to select **Sideguard Assist**.
- ▶ Press the  button to deactivate.

The grey  indicator lamp lights up in the **Assistance** menu window of the on-board computer.

It is possible to switch the trailer monitoring of Sideguard Assist on or off via the trailer menu window.

- ▶ Use the  or  button to scroll to  operation and maintenance.
- ▶ Using the  or  button, scroll to the **Trailer** menu window.
- ▶ Press the  button.
- ▶ Use the  or  button to display the **Sideguard Assist trailer monitoring** input window.
- ▶ Press the  button.
- ▶ Use the  or  button to select **On** or **Off** and press the  button to confirm.

The setting is stored until the next time the trailer/semitrailer is changed.

Level control

Important safety notes

When driving with a lowered or raised chassis, the driving and braking characteristics may be affected. Additionally, the maximum permitted vehicle height may be exceeded when the chassis is raised. Observe the legally permissible vehicle heights for the country you are currently in.

Set the driving level before pulling away.

It is necessary to raise or lower the chassis to pick up or set down demountable bodies or semitrailers. If you continue a journey after having changed the chassis height, it is necessary to lower or raise the chassis to driving level.

If the yellow  indicator lamp in the instrument cluster lights up, the chassis is not at driving level. Observe the additional information in the event window.

When loading/unloading the vehicle with the ignition switched off, observe the information in the section "Loading and unloading the vehicle when the ignition is switched off" (> page 298)

Vehicles with 8x4/4 or 8x2/4 axle configurations with air-sprung rear axle: when operating the vehicle without add-on equipment, make sure that the chassis frame is always fully raised. Otherwise, you could damage the air bellows on the rear axle. Further information on the characteristics of possible add-on equipment can be found in the body/equipment mounting directives.

Vehicles equipped with "driving level lowered" and/or with low profile tyres: avoid operating the vehicle with a lowered chassis frame. Driving with a lowered chassis frame increases wear and tear on the vehicle and reduces driving comfort.

Activating/deactivating the control panel

! Make sure that when securing the control unit in the bracket or behind the driver's seat that the connecting cable does not:

- get trapped in the driver's door
- get trapped in the driver's seat.

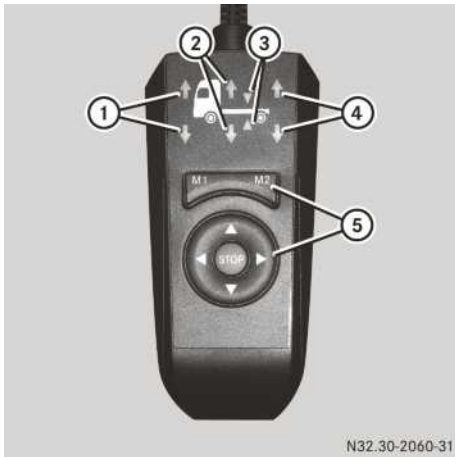

Example: control panel for fully air-sprung vehicles

- ① Preselection to raise or lower the front axle
 - ② Preselection to raise or lower the entire vehicle
 - ③ Preselection to set the driving level
 - ④ Preselection to raise or lower the rear axle
 - ⑤ Buttons
- ▶ To activate the control panel, make a preselection for the front axle, rear axle, entire vehicle or driving level
 - ◀ To activate the control panel, make a preselection for the front axle, rear axle, entire vehicle or driving level
 - ▼ To activate the control panel, lower the chassis, set the driving level
 - ▲ To activate the control panel, raise the chassis, set the driving level
 - ⊞ To activate the control panel, to end lifting or lowering operation

- M1 M2 Press briefly: to call up memory position M1 or M2 for chassis height
- Press and hold: to store memory position M1 or M2 for chassis height

You can operate the level control when the vehicle is stationary or when the vehicle is in motion up to approximately 30 km/h.

Depending on your vehicle's equipment, you control the function of the level control system using:

- the control panel on the driver's seat
- the external control panel on the vehicle body
- the multifunction key (▷ page 58)
- the Truck-App (▷ page 112)
- ▶ Apply the parking brake.
- ▶ Switch the ignition lock to the drive position. The level control automatically adjusts the chassis frame to the previously stored height.
- ▶ If the reservoir pressure in the compressed-air system is too low, leave the engine running. The compressed-air system is charged.
- ▶ Take the control panel out of the holder.

Activating the control panel

- ▶ Control panel on the driver's seat: briefly press the ▶, ◀, ▼, ▲ or ⊞ button.

or

- ▶ External control panel on the vehicle body: press the ⊞ button for approximately 2 seconds.

- ⓘ You can activate/deactivate the external control panel on the vehicle body even if the vehicle key has been removed.

Deactivating the control panel

- ▶ External control panel on the vehicle body: press the ⊞ button again for approximately 2 seconds.

or

- ▶ External control panel on the vehicle body and on the outside of the driver's seat: wait approximately 60 seconds; do not press the button.

or









- ▶ Drive at a speed above approximately 30 km/h. The control panel is automatically deactivated.

Raising or lowering the chassis with the control panel

WARNING

People's limbs may become trapped if they are located underneath the vehicle or between the vehicle body and the tyres when the vehicle is lowering. There is a danger of injury.

When lowering the vehicle, make sure no one is underneath the vehicle or in the immediate vicinity of the wheel arches.

- ▶ Press the  or  button to select front axle ①, entire vehicle ② or rear axle ④. The LEDs for the selected preselection light up.
- ▶ Press the  button to lower the chassis or the  button to raise it.
If the chassis is not at driving level, the  indicator lamp in the instrument cluster lights up. Additionally, a yellow event window appears in the on-board computer with  or  and **Set driving level**.
- ▶ Press the  button to interrupt/cancel the raising or lowering operation.



Raising or lowering the chassis with the button on the instrument panel

WARNING



People's limbs may become trapped if they are located underneath the vehicle or between the vehicle body and the tyres when the vehicle is lowering. There is a danger of injury.

When lowering the vehicle, make sure no one is underneath the vehicle or in the immediate vicinity of the wheel arches.









- ▶ **To raise:** press the upper section of the  button.
The chassis is raised as long as you press the button.
- ▶ **To lower:** press the lower section of the  button.
The chassis is lowered for as long as you press the button.

If the chassis is not at driving level, the  indicator lamp in the instrument cluster lights up.

A yellow event window appears in the on-board computer with  or  and **Set driving level**.

Storing or calling up the chassis height

- ▶ **To store:** raise/lower the chassis to the desired height.
- ▶ Press the  button for approximately 2 seconds for memory position M1 or M2. The current chassis frame height is stored under the corresponding  button.
- ▶ **To call up:** briefly press the  button for memory position M1 or M2. The chassis will be raised/lowered automatically to the stored height.
A yellow event window appears in the on-board computer with  or  and **Set driving level**.
- ▶ Press the  button to interrupt/cancel the raising or lowering operation.

Setting the driving level



Example: STOP and driving level button

- ▶ **Using the button on the instrument panel:** press the button.

The chassis is raised or lowered automatically to the driving level. When the chassis is at driving level, the indicator lamp in the instrument cluster goes out.

- ▶ Press the button to interrupt/cancel the raising or lowering operation.

- ▶ **Using the control panel:** press the or button to select driving level preselection ③.

The LEDs for driving level preselection ③ light up.

- ▶ Briefly press the or button. The chassis is raised or lowered automatically to the driving level. When the chassis is at driving level, the indicator lamp in the instrument cluster goes out.

- ▶ Press the button to interrupt/cancel the raising or lowering operation.

Loading and unloading the vehicle when the ignition is switched off

- ⚠ Before removing the demountable body, lower the chassis frame completely. Otherwise, the chassis frame could spring up suddenly when the special-purpose body is removed. This could damage the shock absorbers.

Store a constant chassis height for loading and unloading the vehicle.

- ▶ Vehicles with a trailing axle: lower the trailing axle (▷ page 300).
- ▶ If required, raise/lower the chassis to the desired height.

- ▶ Run the engine until the pressure regulator cuts out.
- ▶ Press and hold the button on the control panel or the button on the instrument panel.
- ▶ Switch off the engine.
- ▶ Remove the key from the key slot.
- ▶ Release the button on the control panel or the button on the instrument panel. If there is sufficient reservoir pressure in the compressed-air system, the height of the chassis frame is kept constant for approximately 4 to 5 hours.

Forced lowering without residual air bellow pressure regulation

Forced lowering

If you engage power take-off, the vehicle is completely lowered on all air-sprung axles. This increases the vehicle's tilt stability. If you disengage power take-off, the vehicle remains lowered until you select a level.

Forced lowering is ended if:

- you switch the ignition off and on again
- you press the button on the control unit
- you press the button on the instrument panel
- you press the button

Road paver mode





Example: road paver mode button





In road paver mode, the level control permanently regulates the driving level, regardless of operating conditions. This enables the level relative to the road paver to be maintained and forced lowering is deactivated.

- ▶ **To activate:** press the upper section of the  button.

The indicator lamp in the  button flashes and the function is preselected.

- ▶ Engage power take-off (▷ page 341). The  symbol and an event message appear in the display. The indicator lamp in the  button is on and the function is activated.







▶ **To deactivate:**

- ▶ Press the  button on the control panel.
- ▶ Press the  button on the instrument panel.
- ▶ Increase vehicle speed to more than 10 km/h.
- ▶ Switch off the ignition. The  symbol in the display and the indicator lamp in the  button go out.

Raised vehicle level (vehicles for large-capacity transport)



To improve ride comfort, raise the chassis frame while the vehicle is in motion.

- ▶ **To raise the chassis to the raised driving level:** press the upper section of the  button. The indicator lamp in the  button and the  indicator lamp in the instrument cluster light up.
- ▶ **To lower the chassis to the normal driving level:** press the upper section of the  button again. The indicator lamp in the  button goes out. When the chassis is lowered to the normal driving level, the  indicator lamp in the instrument cluster goes out.

Shunting level



Example: raised driving level and shunting level

At shunting level, it is possible to move the vehicle slowly when not at driving level. If the vehicle is in shunting level, the front and rear axles are raised above driving level.

The rear axle is raised higher than the front axle.

- ▶ **i** On car transporters, the rear axle is raised higher than the front axle. This is to prevent the car transporter from bottoming out to avoid damage.



If you drive too fast at shunting level, a yellow event window appears in the on-board computer.



- ▶ Stop the vehicle.

or



- ▶ Drive at walking pace.

- ▶ **To activate shunting level:** press the lower section of the  button.

The indicator lamp in the  button and the  indicator lamp in the instrument cluster light up. The on-board computer also shows the **Shunting level active** event window. The chassis lowers or rises to the shunting level.

- ▶ **To deactivate shunting level:** press the lower section of the  button again. The indicator lamp in the  button and the event window in the on-board computer go out. The chassis lowers or rises to driving level. When the chassis lowers to the normal driving level, the  indicator lamp in the instrument cluster goes out.

Shunting level is automatically activated if you:

- lower or raise the chassis manually
- set a raised or normal driving level
- press the  button on the control panel or the  button on the instrument panel

Additional axles



Starting-off aid

! The starting-off aid is only intended for short-term use for spinning wheels on snow and ice-covered roads. If you activate the starting-off aid, the rear axle load increases. Using the starting-off aid for longer periods could damage the rear axle. When doing so, if the tyre load-bearing capacity is exceeded for longer periods, the tyres can explode.



The starting-off aid can also be installed with a speed limiter or a time limit (switch-on interlock). If the starting-off aid does not have a time limit, then make sure that the starting-off aid is only activated for a short period.

- The starting-off aid with speed limiter automatically switches off at a vehicle speed of above 30 km/h. The starting-off aid can only be activated again when the speed falls below 30 km/h.
- The starting-off aid with switch-on interlock switches off automatically after 90 seconds. After 50 seconds, the starting-off aid with switch-on interlock can be reactivated.
- The starting-off aid without switch-on interlock is deactivated automatically after 120 seconds and can be reactivated immediately thereafter.

► **To activate the starting-off aid:** press the  button. As long as the starting-off aid is activated, the  indicator lamp in the status area of the on-board computer lights up yellow.

i If the starting-off aid does not have a time limit, deactivate the starting-off aid manually after a short period of time.

► **To deactivate the starting-off aid manually:** press the  button on the instru-

ment panel or the  button on the control panel of the level control (► page 298).

Leading/trailing axle

Environmental note

When the leading/trailing axle is raised, roll resistance is reduced. This reduces tyre wear and fuel consumption.







The leading/trailing axle is lowered just before the permissible axle load is reached. Observe the notes in the "Axle loads and wheel loads" section (► page 266) and those on the vehicle identification plate (► page 417).



On vehicles for the transportation of bulk cargo, weight can only be taken off the trailing axle and it cannot be raised.

Vehicles with a steerable trailing axle (► page 301): when you raise the additional axle, the wheels move into the straight-ahead position. When you lower the additional axle, the wheels again steer actively.

- Switch the ignition lock to the drive position.
- If the reservoir pressure in the compressed-air system is too low, leave the engine running.
- If the vehicle is empty or only partially laden, raise the leading/trailing axle before pulling away.
- Vehicles with a rear loading crane: observe the information in the manufacturer's operating instructions before raising the leading/trailing axle.

- ▶ When loading or unloading the vehicle, lower the leading/trailing axle.
- ▶ **To raise/lower:** press the  button. When the leading/trailing axle is raised, the  (trailing axle) or  (leading axle) indicator lamp lights up yellow in the status area of the on-board computer.

Vehicles with four air-sprung axles: the trailing axle lowers automatically when you apply the parking brake. As a result, braking performance is increased. As the vehicle briefly lowers, the yellow  indicator lamp flashes in the instrument cluster.

If the trailing axle has not lowered, the yellow  indicator lamp flashes continuously when the ignition has been switched on. After the key has been removed from the ignition, the yellow  indicator lamp flashes for another ten minutes and then goes out.

If the trailing axle has not lowered, secure the vehicle in particular against rolling away. Have the trailing axle checked immediately at a qualified specialist workshop.

Steerable additional axle





- ! When manoeuvring close to kerbstones or when travelling through narrow passages, there is a risk of tyre damage. In such cases, centre the steering of the additional axle.



The electro-hydraulically controlled additional axle steers in accordance with the angle of the steering wheel when driving forwards and reversing. This active steering reduces tyre wear. A steerable trailing axle also reduces the turning circle of the vehicle.

In extreme driving conditions, e.g. when braking hard on a slippery or uneven road surface, the steerable additional axle may deactivate itself. It will then only steer passively. After the engine is

restarted, the steering function of the additional axle is re-activated automatically.

- ▶ Start the engine.
- ▶ **To centre manually:** press the upper section of the  button. The steering of the additional axle is centred. The wheels on the additional axle move to the straight-ahead position. When the  indicator lamp lights up in the status area of the on-board computer, the additional axle is centred.
- ▶ **To unlock a steering function:** press the upper section of the  button again. When the  indicator lamp in the status area of the on-board computer goes out, the steering function of the additional axle is activated. The additional axle again steers actively.

If the steerable additional axle is malfunctioning or no longer steers actively:

- The  indicator lamp in the status area of the on-board computer lights up.
- The on-board computer displays a corresponding event window.

When the  indicator lamp lights up grey in the status area of the on-board computer, the difference in the steering angle between the fully locked front axle wheels and the steerable additional axle is too great. The vehicle was parked with the steering at full lock, for example. The steerable additional axle will not steer actively.

- ▶ Turn the multifunction steering wheel to the left and the right as far as it will go. The steerable additional axle is picked up by turning the steering wheel. The additional axle again steers actively. The  indicator lamp in the status area of the on-board computer goes out.

or

- ▶ Pull away slowly. The additional axle again steers actively. The  indicator lamp in the status area of the on-board computer goes out.

Information on raising and lowering a height-adjustable additional axle can be found in "Leading/trailing axles" (▷ page 300).

Driving tips

General notes on driving

⚠ WARNING

If you switch off the ignition while the vehicle is in motion, safety-relevant functions are restricted or not available. This can affect the power steering function and the brake boosting effect, for example. You will then require considerably more force to steer and brake. There is a risk of an accident.

Do not switch off the ignition while the vehicle is in motion.

⚠ WARNING

The parking brake may not be sufficient to secure the vehicle on uphill and downhill gradients. A loaded vehicle or a vehicle with trailer/semitrailer may roll away. There is a risk of an accident.

In the control position, check whether the parking brake alone can hold the entire vehicle. The tractor unit and trailer/semitrailer should normally be secured using the parking brake and wheel chocks.

⚠ WARNING

If you load the vehicle unevenly, driving characteristics such as steering and braking behaviour may be severely impaired. There is a risk of an accident.

Load the vehicle evenly. Secure the load so that it cannot slip.

The vehicle's driving, braking and steering characteristics vary with the type, weight and centre of gravity of the load.

Parts required for vehicle transfer

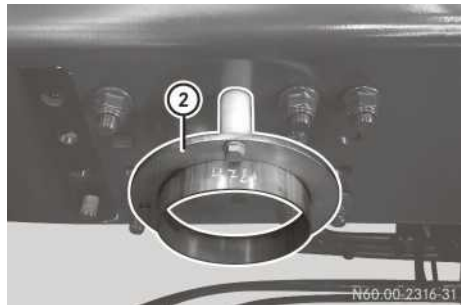

The following parts required during vehicle transfer are also assembly parts required by the body manufacturer:

- ① Additional pipe on the exhaust pipe
- ② Adapter connection for recess heating
- ③ Tail pipe attachment for recess heating on the exhaust gas aftertreatment unit

After vehicle delivery, the parts required during vehicle transfer must be removed and stored safely.

If the vehicle is transferred again without the body, the tail pipe attachment for recess heating must be refitted onto the exhaust gas aftertreatment unit. This prevents dust and water entering the exhaust gas aftertreatment unit.

Underride guard

General notes

WARNING

If the underride guard is folded up, in a collision with the vehicle in front this vehicle could become trapped underneath the frame. There is a risk of fatal injury for the occupants of the vehicle in front.

Fold the underride guard down and lock it in place when driving on public roads.

You can achieve a higher approach/departure angle when driving off-road if you fold up the underride guard.

Collapsible underride guard – tipper with steel suspension

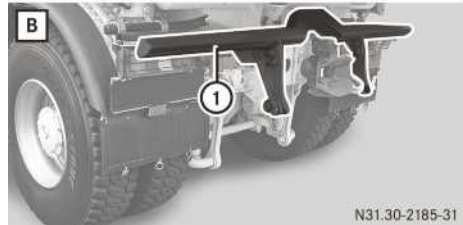

N31.30-2185-31

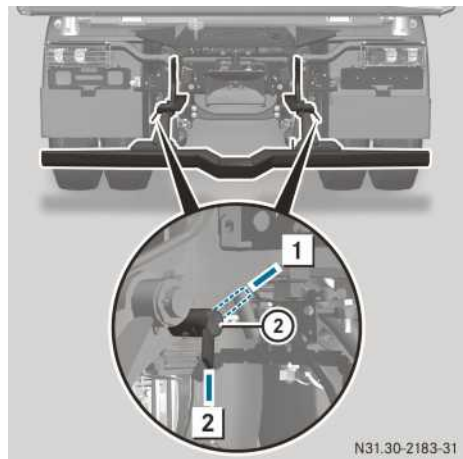

N31.30-2183-31

A Road position

B Off-road position/road paver operation position

- ▶ Hold underride guard ① in position.
- ▶ Swing both levers ② to position ②. Underride guard ① is released.
- ▶ Swing underride guard ① into the desired position and hold it in place.
- ▶ Swing both levers ② to position ① and release underride guard ①. Underride guard ① is locked.

Collapsible underride guard – tipper with air suspension

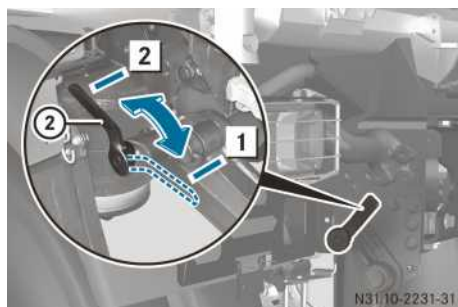
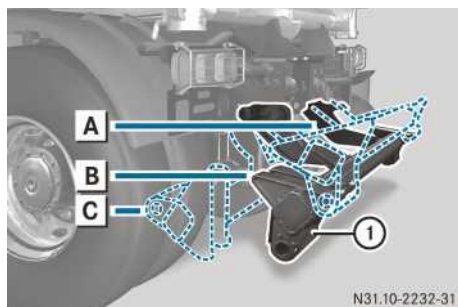

Example: lever, left-hand side of the vehicle

A Off-road position

B Road position

C Road paver operation position

- ▶ Hold underride guard ① in position.
- ▶ Swing both levers ② to position ②. Underride guard ① is released.
- ▶ Swing underride guard ① into the desired position and hold it in place.
- ▶ Swing both levers ② to position ① and release underride guard ①. Underride guard ① is locked.

i If you swing underride guard ① into road finishing machine operation position **C**, leave both levers ② in position **2**.

Road paver operation

Preparing for road paver operation

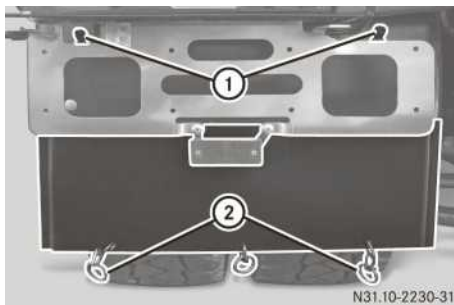

Example: mud flap, left-hand side of vehicle

- ▶ Set the underride guard to the road paver operation position.
- ▶ Swing both mud flaps ② up over the licence plate holder.
- ▶ Attach the rings of mud flaps ② to hooks ① on the licence plate holder.

Notes on road paver operation – tipper with steel suspension



Tipper with steel suspension in road paver operation (overrun mode)

In road paver operation, the roller of the road paver presses against the tyres. This causes the vehicle to be pushed forwards at the speed of the road finishing machine.

Do not use the parking brake in overrun mode and only perform slight adaptive braking with the service brake.

Notes on the road paver – tipper with air suspension

WARNING

When the underride guard is pressed against the tyres, persons could become trapped between the tyres and the underride guard. There is a risk of injury.

Make sure that there is no-one in the area between the tyres and the underride guard.

- !** Make sure that the underride guard is not engaged in road finishing machine operation. The locking levers must be released and the underride guard must be able to swing freely. The underride guard or the chassis could otherwise be damaged.



Tipper with air suspension in road paver operation (overrun mode)

In road paver operation, the road paver presses the rollers on the underride guard against the tyres. This causes the vehicle to be pushed forwards at the speed of the road finishing machine.

Shift the level control to road paver operation (> page 295).

For most road pavers, the optimal road paver roller position is preset. The road paver rollers should touch the approach plate roughly in the centre.

Do not use the parking brake in overrun mode and only perform slight adaptive braking with the service brake.

- i** The vehicle's level will be adjusted automatically. If the road paver rollers do not touch the centre of the approach plate, a different driving level can be set before power take-off is activated (> page 295).

Driving off-road

Important safety notes

WARNING

When driving off-road, your body is subject to forces from all directions due to the uneven surface. You could be thrown from your seat, for instance. There is a danger of injury.

Always wear a seat belt, even when driving off-road.

WARNING

If ABS is deactivated, the wheels may lock when braked. As a result, the vehicle can no longer be steered. There is an increased risk of skidding and an accident.

Always leave ABS on when driving on roads and firm surfaces.

- !** If the vehicle is being driven off-road, it can be damaged by obstacles.

Obstacles may damage vehicle parts such as:

- axles
- propeller shafts
- fuel tank
- compressed-air reservoir
- engine
- transmission

For this reason, you should always drive slowly when off-road. Ask passengers for guidance when driving over obstacles. Always observe the vehicle's ground clearance. Avoid obstacles if possible.

- !** When driving the vehicle on rough terrain, ensure that the drive wheels always have sufficient traction. Avoid wheelspin of the drive wheels. You could otherwise damage the differential gear system.

Driving off-road increases the possibility of damage to the vehicle, which may cause assemblies or systems to fail. Adapt your driving style to the conditions of the terrain. Drive carefully. Have vehicle damage rectified immediately at a qualified specialist workshop.

When driving off-road, substances such as dirt, sand, mud and water or water mixed with oil may get into the brakes. This may lead to a reduction in braking performance or total brake failure as

a result of increased wear. The braking characteristics will vary depending on the substances that get into the brakes. Clean the brakes after driving off-road. If you notice grinding noises or a reduction in braking performance, have the brake system checked at a qualified specialist workshop immediately. Adapt your driving style to suit the altered braking characteristics.

Driving off-road demands special driving skills and concentration. Furthermore, the driver must take special care when driving off-road and before driving on-road again.

Please make sure you read this section thoroughly before attempting to drive the vehicle off-road. You will then understand the particular advantages your vehicle offers to enable you to always reach your destination safely.

Mercedes-Benz recommends that you practice driving off-road in less demanding terrain. When driving on difficult terrain for the first time, ask an experienced off-road driver to accompany and advise you.

Driving systems for driving off-road

! Only engage the differential locks if there is equal traction on all wheels. You could otherwise damage the differential locks.

The following driving systems and equipment help you to safely drive off-road:

- ABS deactivation (▷ page 246)
- Differential locks (▷ page 268)
- Transfer case (▷ page 270)

Checklist before driving off-road

- ▶ Check the fuel and AdBlue® supplies (▷ page 129) and top up (▷ page 315).
- ▶ **Engine:** check the oil level (▷ page 148) and top up the oil (▷ page 360).
Before driving up or down steep gradients, fill the oil to the maximum level.
- i** If you drive up or down steep gradients, the  symbol may appear in an event window on the on-board computer. The engine operating safety is not put at risk if you have filled the engine oil to the maximum level before the journey.
- ▶ **Vehicle tool kit:** check that the jack is working (▷ page 370).

- ▶ Make sure that a wheel bolt wrench, wooden underlay for the jack, a robust tow cable and a folding spade are carried in the vehicle.
- ▶ **Tyres and wheels:** check the tread depth (▷ page 402) and tyre pressure (▷ page 405).
- ▶ **Driver's seat:** block horizontal springing.
- ▶ **Mud flaps:** fold the mud flaps forward and attach them.
- ▶ **Folding underride guard:** fold the underride guard to the off-road position (▷ page 303).

Rules for off-road driving

WARNING

If you drive over obstacles or in ruts, the steering wheel may jerk out of your grip, causing injury to your hands.

Always hold the steering wheel firmly with both hands. When driving over obstacles, you must expect steering forces to increase briefly and suddenly.

WARNING

When driving off-road or driving with an engaged differential lock in the automatic driving program, the electronic management system may perform unwanted gear changes. Due to the interruption in the tractive power, the vehicle may roll backwards on uphill slopes, for instance. There is a risk of an accident.

Always drive carefully and be prepared to brake. In particularly difficult driving conditions, switch to the manual driving program.

On gradients and inclines, always follow the line of fall and avoid changing gear. Drive up gradients without stopping until you are at the top of the hill. If your vehicle is unable to cope with the gradient, stop. Shift into reverse gear and allow the vehicle to slowly roll backwards.

Vehicles with an automated manual transmission: the vehicle has a selectable crawler mode. When crawler mode is activated, the vehicle crawls automatically when the service brake is released and continues rolling at the engine idling speed (▷ page 257). When driving in difficult terrain or on journeys with the differential

gears engaged, drive carefully and be ready to brake. Select the **offroad** gearshift program adapted for off-road driving. In particularly difficult driving conditions, switch to the manual driving program. This enables you to initiate the gear selection process manually, according to the driving conditions, and to avoid interruptions in the tractive power.

Vehicles with level control: leave the chassis frame set to driving level (▷ page 297). Raise the chassis frame only when necessary and always for a short time only, e.g. to drive over a steep hilltop. When you raise the chassis frame, traction is impaired.

- ▶ Securely stow away all loose objects.
- ▶ Securely fasten the load.
- ▶ Secure bulk material (e.g. sand or gravel) with slip-on walls or covers to prevent it slipping.
- ▶ Secure add-on and attached equipment, such as tipper bodies or loading cranes, against inadvertent activation and movement. Observe the operating instructions given by the body and equipment manufacturer.
- ▶ Close the side windows (▷ page 67).
- ▶ Vehicles with automated transmission: select the **offroad** gearshift program or activate the manual drive program (▷ page 255).
- ▶ Deactivate ASR (▷ page 266) or Stability Control Assist (▷ page 267).
- ▶ Deactivate ABS (▷ page 245).
- ▶ Engage the differential lock if the traction is insufficient (▷ page 268).
- ▶ Vehicles with automated manual transmission: to rock the vehicle free from a deep rut: activate the rocking-free function.
- ▶ Always keep the engine running and in gear while driving.
- ▶ Drive slowly and smoothly. It may often be necessary to drive at walking pace.
- ▶ Make sure that the wheels remain in contact with the ground.
- ▶ Drive with extreme care over unknown terrain where you can only see for a short distance. As a precaution, get out of the vehicle to take a look at the route to be taken first.
- ▶ Watch out for obstacles such as rocks, holes, tree stumps and ruts.
- ▶ If possible, always drive over obstacles with the wheels of one side of the vehicle. This means damage to the vehicle is avoided.

Driving on inclines

WARNING

If you drive on a steep incline at an angle or turn on a steep incline, the vehicle could slip sideways, tip and overturn. There is a risk of an accident.

When driving on an incline, drive into the line of fall (upwards or downwards in a straight line) and do not turn.

Do not shift the transmission into neutral on downhill gradients.

- ▶ If the vehicle is being driven up or down a slope and it begins to tilt, steer the vehicle into the line of the fall immediately. Only drive over embankments and on slopes along the line of fall.
- ▶ Only brake once the vehicle is on the line of fall.
- ▶ Slowly depress the brake pedal if the engine's braking effect is insufficient when driving downhill.

Fording

Before fording

A vehicle's fording capability depends on, among others:

- type of vehicle
- frame height of the chassis
- tyres

The fording depths named below are only examples and are meant to give an overview. They apply to slow fording with a constant speed between 5 and 10 km/h maximum.

If in doubt, or in the case of special-purpose vehicles, consult a Mercedes-Benz Service Centre before a possible fording.

Permissible fording depths for vehicles in road use **without** all-wheel drive:

- street vehicles with a low chassis frame and 315/60 R 22.5 tyres, up to 200 mm
- construction vehicles with 315/80 R 22.5 300 mm tyres, up to 500 mm
- other street vehicles with 315/80 R 22.5 tyres, up to 300 mm
- other street vehicles with oversize tyres, e.g. 12 R 24 or 14 R 20, up to 600 mm

Permissible fording depths for fording with all-wheel-drive vehicles:

- with 13 R 22.5 tyres, up to 700 mm without fording equipment
- up to 1,200 mm with fording equipment

On vehicles with fording equipment, a plate with the details of the vehicle-specific permissible fording depth can be found on the driver's door or on the dashboard.

Fording as described here applies exclusively to off-road and all-wheel-drive vehicles.

- ▶ Determine and observe the maximum permissible fording capability of the vehicle.
- ▶ Determine the water depth and the characteristics of the surface condition under the water. As a precaution, have a closer look on foot.
- ▶ Switch off the auxiliary heating system (> page 125).
- ▶ Wait for the auxiliary heating run-on phase to end.
- ▶ Switch on the regeneration block (> page 312).

Driving through water

- ! If you drive into water at speed, the bow wave may damage parts of the vehicle.
- ▶ Drive into the water at walking pace at a shallow point.
- ▶ Adapt your driving style to the unaccustomed environment.
- ▶ Drive through the water with a constant speed between 5 and max. 10 km/h.
- ▶ Do not declutch, change gear or stop while driving.
- i Pulling away in water is difficult due to the strong resistance and the shallow bottom.
- ▶ Ensure that no bow wave forms while driving.
- ▶ Do not switch off the engine while in the water.
- ▶ If the engine cuts out while in the water, start it again immediately.

After fording

- ▶ If the terrain characteristics permit, dry the brakes with short braking manoeuvres.
- ▶ Drive on or leave the engine running for a few minutes.
The engine compartment is dried.

- ▶ Switch off the regeneration block (> page 312).
- ▶ After ending off-road driving, observe the checklist for after off-road driving (> page 308).

Driving on sand

Loose sand is a particularly treacherous surface for off-road driving.

- ▶ Drive quickly to overcome rolling resistance.
- ▶ Drive in the tyre tracks of vehicles ahead.
- ▶ Pay attention to the vehicle's ground clearance in the case of deep tyre ruts.

Checklist after driving off-road

- ! Parts of plants or branches which have become trapped may damage the following components:
 - fuel lines
 - brake lines
 - axle joints
 - drive shafts
- ▶ Activate ASR (> page 266) or Stability Control Assist (> page 267).
- ▶ Switch on ABS (> page 245).
- ▶ Disengage the differential lock (> page 268).
- ▶ Vehicles with automated manual transmission: select the drive program for on-road driving (> page 255).
- ▶ Test the brakes.
- ▶ Check the headlamps and tail lamps for damage.
- ▶ Check for damage to the tyres.
- ▶ Replace buckled or damaged wheels.
- ▶ Replace missing valve caps and valve extensions.
- ▶ Check and adjust the tyre pressure (> page 405).
- ▶ Check whether parts of plants or branches have become trapped.
- ▶ Check the entire vehicle underside, brakes, steering, chassis and exhaust system for damage.
- ▶ Check the engine oil level (> page 148).
- ▶ Fold the folding underdrive guard to the road position (> page 303).

- ▶ Fold down the mud flaps.
- ▶ Observe the notes on cleaning after driving off-road or on construction sites.

Cleaning after driving off-road or on construction sites

! Only direct the compressed-air, steam or water jet towards the radiator surface in a vertical direction. Ensure that the radiator fins are not damaged. Remove any dirt from the radiator fins. Damaged or dirty radiator fins can cause the engine to overheat. If there is a loss of coolant or damage to the cooling and heating system, have it checked at a qualified specialist workshop.

! When using a high-pressure cleaner, keep a minimum distance of approximately 30 cm between the high pressure nozzle and the vehicle parts. Do not use a high-pressure cleaner with a round jet nozzle. Parts of the vehicle or engine can otherwise be damaged.

Foreign bodies that have become trapped can be expelled during the journey, e.g. stones in the tyre tread or between the tyres (twin tyres). This could cause other road users to be injured or vehicles – especially the windscreens – to be damaged.

Check the tyres for foreign bodies that have become trapped after every journey off-road or on a construction site and before journeys on public roads. Remove any trapped foreign bodies.

Dirt and mud on the tyres and on the road surface reduce road grip, particularly if the road surface is wet. This could cause your vehicle to start to skid. Always clean your vehicle carefully after every journey off-road or on a construction site and before journeys on public roads.

Clean the following vehicle parts after a journey off-road or on a building site:

- lighting system
- side windows and windscreen
- exterior mirrors
- Steps
- door sills
- grab handles
- wheels and tyres
- wheel housing and mudguard
- steering

- axles
- brakes
- spring elements
- chassis
- licence plate
- engine
- engine radiator
- transmission
- oil cooler (transmission)
- ▶ Clean wheels, tyres and wheel housings and remove foreign objects, e.g. stones.

After operation in mud, sand, water or after exposure to similar dirty conditions:

- ▶ Clean the brake discs, brake linings, wheels and axle joints and check them for damage.
- ▶ Lubricate the axle joints.
- ▶ Test the brakes while paying attention to the road and traffic conditions.

Economical and environmentally-aware driving

General notes

Fuel consumption depends on:

- the vehicle version
- the operating conditions
- maintenance
- the fuel type in use
- driving resistance
- your driving style

Vehicle version

The following components affect fuel consumption:

- tyres, e.g. tyre pressure, tyre condition, tyre size
- add-on equipment and vehicle cab version, e.g. open platform, box-type body, platform with tarpaulin
- drive train, assemblies and the number of axles
- ratio of the drive assemblies, e.g. transmission and axle reduction ratio
- additional equipment, e.g. air-conditioning system, auxiliary heating, power take-offs

Operating conditions

The following operating conditions affect fuel consumption:

- topography, e.g. driving on level routes or in mountainous terrain
- outside temperature and weather conditions
- operating conditions, e.g. operation on construction sites, long distance or short distance driving
- gross vehicle weight
- regeneration of the diesel particle filter

When the vehicle is in new condition, the regeneration of the diesel particle filter is carried out more frequently than at later stages in the vehicle's operating life as a result of the teach-in process.

Maintenance

The fuel consumption and assembly wear depend on regular maintenance. Regular maintenance of the vehicle increases road safety and lowers fuel consumption. Keep to the maintenance intervals. Always have maintenance work carried out at a qualified specialist workshop.

Fuel type

The fuel grade also affects fuel consumption. Use of lower fuel grades and/or non-approved fuel additives will increase fuel consumption. Ensure that you refuel with the appropriate fuel grade (▷ page 422).

Driving resistance

General notes

The principle forms of driving resistance are incline, rolling and aerodynamic resistance. Driving resistance changes depending on, for example, vehicle weight and vehicle speed. Remember that driving resistance increases with vehicle speed.

Rolling resistance

Rolling resistance and therefore fuel consumption are affected by the following factors:

- tyre size and tyre type
- tyre pressure, e.g. correctly set tyre pressure reduces fuel consumption

Check the tyre pressure at regular intervals (▷ page 405).

- tyre type, e.g. summer or winter tyres, single or twin tyres
- tyre tread and tyre width, e.g. coarse tyre treads such as those on winter tyres increase fuel consumption
- load distribution, e.g. even load distribution increases not only driving safety, but also tyre life

Observe the notes on the permissible wheel and axle loads (▷ page 266) and the data on the vehicle identification plate (▷ page 417).

- road and weather conditions, e.g. wet or soft road surfaces (snow or rain) increase fuel consumption

Aerodynamics

Air turbulence increases aerodynamic resistance and therefore fuel consumption. Air turbulence occurs in particular at additionally installed equipment, e.g. auxiliary headlamps.

- Set the wind deflector to the correct height of the add-on equipment/semitrailer (▷ page 332).
- With open loads, arrange the load so that there are no gaps. Cover the load with a tarpaulin.
- Lash down all tarpaulins on the tractor/trailer combination securely.

Fuel-saving driving styles

Environmental note

Only switch on the air-conditioning system when necessary. Fuel consumption increases when the air-conditioning system is switched on.

The **FleetBoard EcoSupport** menu window in the  driving mode menu shows information on economical driving style (▷ page 138). The on-board computer supports you in optimising your driving style and developing a fuel-saving driving style.

You can keep fuel consumption at low levels with your driving style:

- Leave PPC switched on (▷ page 282).
- Do not depress the accelerator when starting the engine.
- Avoid frequent cold starts.

- Do not warm up the engine while stationary.
- Switch off the engine when waiting in stationary traffic.
- Avoid frequent and heavy acceleration.
- Avoid adaptive braking by driving with foresight.
- Drive in an even and considered manner. Use cruise control (▷ page 276) and the distance control assistant driving systems (▷ page 278).
- Take care to keep to an economical engine speed (green area of the rev counter) (▷ page 128).
- Avoid speed peaks.
- Avoid frequent speed changes, in particular at high speeds.
- Whenever possible, drive using the automatic drive program.
- Shift gears according to requirements.
- Avoid frequent gear changes.

Diesel particle filter

Important safety notes

WARNING

Flammable material such as leaves, grass or twigs may ignite if they come into contact with hot parts of the exhaust system or exhaust gas flow. There is a risk of fire.

Park the vehicle so that no flammable material can come into contact with hot vehicle components. In particular, do not park on dry grassland or harvested grain fields.

BlueTec®6 vehicles are equipped with a diesel particle filter.

- ❗ During automatic and manual regeneration, extremely hot exhaust gases escape from the exhaust pipe. Maintain a distance of at least one metre to other objects, e.g. parked vehicles, in order to avoid damage to property.

If the regeneration period exceeds 3 hours during a journey, switch on the regeneration block (▷ page 312).

If too many particles collect in the diesel particle filter, the  indicator lamp in the instrument cluster lights up. The on-board computer then instructs you with a yellow event window to start

manual regeneration (▷ page 158). Manual regeneration lasts approximately 30 minutes up to a maximum of 60 minutes (▷ page 312).

- ❗ If you drive the vehicle predominantly over short distances or with low loads, the regeneration period may be considerably increased. Therefore, the fuel consumption increases and the range of exhaust system functions may be impaired.

If you do not observe the yellow event windows and their instructions, you risk:

- a reduction in engine performance
 - having to replace the diesel particle filter (▷ page 176)
- i** When in the on-board computer the message  **Engine speed increase** appears, the "HC burn-off" feature reduces deposits of hydrocarbons in the catalytic converter.

This is done by increasing the engine speed. The process cannot be cancelled once the message has appeared.



When the process is completed, the message disappears automatically.

"HC burn-off" does not regenerate the diesel particle filter.

Automatic regeneration

When the green  indicator lamp lights up in the instrument cluster, automatic regeneration of the diesel particle filter is in progress.

Automatic regeneration is only carried out while the vehicle is in motion.

Automatic regeneration only begins when all operating conditions have been fulfilled, e.g. sufficiently high engine oil and coolant temperature. If an operating condition is no longer fulfilled while regeneration is in process, the  indicator lamp goes out and the regeneration is interrupted. When all operating conditions are fulfilled again, the regeneration starts again automatically. Therefore, avoid interruptions in driving as long as the  indicator lamp is lit.

- i** The engine noise and the engine idling speed may change while regeneration is in process.



Regeneration block

If you need to avoid the increased emission temperatures that occur during regeneration, you can disable regeneration, for example, when you are:

- entering a hazardous area
- performing work which causes intense build-up of dirt on the vehicle, involving dry or flammable materials



Automatic and manual regeneration can then no longer be started and any current regeneration will be interrupted.

Only switch on the regeneration block for as long as the hazardous condition prevails. If you have switched on the regeneration block, regeneration remains blocked even after starting the engine again. In this case, the on-board computer informs you that the regeneration block is still active by means of the  **Regeneration disabled** message in a grey event window.

Block regeneration via the **Systems** menu window in the  settings menu (▷ page 151). Only in vehicles for the transport of hazardous goods or with the **fire-sv** gearshift program, switch the regeneration block on or off using the  button.





Only vehicles with an ADR classification or the **fire-sv** gearshift program:

- ▶ **To switch on/off:** press the lower section of the  button. When the indicator lamp in the  button lights up, regeneration is blocked.

Starting manual regeneration





Manual regeneration lasts approximately 30 minutes up to a maximum of 60 minutes.

Start manual regeneration via the **Systems** menu window in the  settings menu (▷ page 151). Only in vehicles for the transport of hazardous goods or with the **fire-sv** gearshift program, start manual regeneration using the  button.

You can only start manual regeneration if:

- the on-board computer has prompted you to do so with corresponding event windows
- the regeneration block is not switched on
- ▶ Stop the vehicle, paying attention to road and traffic conditions, and keep the engine running. While doing so, maintain a distance of at least 1 metre to other vehicles, other objects and all flammable materials.
- ▶ Apply the parking brake.
- ▶ Shift the transmission to neutral position **N**.
- ▶ Remove your foot from the accelerator.
- ▶ Start **DPF regeneration** via the **Systems** menu window in the  settings menu (▷ page 151).

or

- ▶ Vehicles with ADR classification or the **fire-sv** gearshift program: press the upper section of the  button for approximately 3 seconds. Manual regeneration only begins if:
 - the engine oil and coolant temperature are sufficiently high
 - AdBlue® is not frozen
 - the system is functioning trouble-free
 The  indicator lamp lights up in the instrument cluster and the engine speed is increased.

When regeneration is finished:

- the  indicator lamp in the instrument cluster goes out
 - the engine speed is reduced to idling speed
- Regeneration is automatically interrupted if you:
- move the multifunction lever to position **D** or **R**
 - release the parking brake
 - switch on the regeneration block
 - engage power take-off

The interruption reduces the engine speed to idling speed.

i The engine speed may rise and the engine noise may change while regeneration is in process. Observe the increased engine speed when operating with power take-off.

i If the on-board computer prompts you to carry out manual regeneration when the outside temperature is low, start regeneration before parking the vehicle.

If you park the vehicle without regenerating, you can only begin manual regeneration after the engine warming-up phase.

Start the manual regeneration after a thawing time of up to 60 minutes if:

- AdBlue® is frozen
- you have parked up the vehicle without performing regeneration

Replacing the filter

WARNING

Direct contact or inhalation of soot particles is hazardous to health. There is a risk of injury. Have the diesel particle filter replaced at a qualified specialist workshop.

Fuel consumption

Fuel consumption depends on:

- the vehicle version
- the operating conditions
- the fuel type in use
- maintenance
- driving resistance
- your driving style

For these reasons, exact figures about any individual vehicle's fuel consumption cannot be provided.

Information and notes on how to keep fuel consumption to a minimum can be found in the "Economical and environmentally-aware driving" section (▷ page 309).

i The on-board computer shows information on the average fuel consumption in the trip data menu  (▷ page 137).

AdBlue® consumption

AdBlue® consumption with BlueTec® is up to 5.5% of fuel consumption.

Engine oil consumption

After running-in the engine, oil consumption may reach 0.2% of the vehicle's fuel consumption.

Increased distance covered and more arduous operating conditions could result in vehicles exceeding this value.

Limiting the speed

WARNING

If the vehicle combination swerves, you could lose control of the vehicle combination. The vehicle combination may even overturn. There is a risk of an accident.

On no account should you attempt to straighten up the vehicle combination by increasing the speed. Reduce your speed and do not countersteer. Brake if necessary.

On vehicles with a speed limiter, the maximum speed of the vehicle is limited according to national legal requirements, e.g. to approximately 90 km/h.

The engine speed is automatically limited when the restricted top speed is reached. Take this into account when overtaking.

Reverse warning device

WARNING

Other road users may ignore or fail to hear the warning tone of the reverse warning feature. There is a risk of injury if you fail to ensure that the area in which you are manoeuvring is clear.

Make sure that there are no persons or objects in the area in which you are manoeuvring. It may be necessary to enlist the help of a second person when manoeuvring.



The reverse warning feature is a system designed to assist you in ensuring the safety of other road users. The reverse warning feature cannot guarantee that there are no people or objects behind your vehicle.

The reverse warning feature is an acoustic warning system that is integrated into one of the vehicle's tail lamps. If reverse gear is engaged, the reverse warning device is activated and issues a warning tone.

When using the reverse warning device described here, observe the legal requirements for the country you are currently in.

When you switch on the ignition and shift into reverse gear, the reverse warning device is activated and always set to loud.

► **To activate/deactivate the reverse warning device:** press and hold the  button for longer than 2 seconds.

The reverse warning device is deactivated regardless of whether you have engaged reverse gear.

Vehicles with automatic activation of the hazard warning lamps (equipment dependent): a tone sounds and the hazard warning lamps

are switched on when reverse gear is engaged.

► **To set the reverse warning device to quiet/loud:** briefly press the  button.

If the reverse warning device is set to quiet, the indicator lamp lights up in the  button.

If reverse gear is not engaged, volume reduction remains active for approximately 2 minutes. The reverse warning device is then loud again.

Reverse gear lock

Refuse-collection vehicles only:



If the running boards in the rear area are loaded, the vehicle speed is limited to a maximum of approximately 30 km/h and the reverse gear lock is activated. The reverse gear lock prevents reverse gear selection.

If the running boards in the rear area are loaded while reverse gear is engaged, a warning tone sounds and the engine switches off.

If the engine has been switched off by the reverse gear lock:

- Switch the ignition lock to position 0.
- Apply the parking brake.
- Shift into neutral.
- Restart the engine.

Warning tone

 If a warning tone sounds and the red event window with the  symbol appears in the on-board computer, the operating safety of the engine is jeopardised.

Do not pull away, or stop the vehicle as soon as possible, paying attention to road and traffic conditions. You could otherwise damage the engine.

A warning tone sounds if:

- the driver's door is opened with the dipped-beam headlamps on and the ignition lock in radio position
- the driver's door is opened with the side lamps switched on and the ignition off
- you have not fastened the seat belt on the driver's seat
- the immobiliser is activated

- you do not depress the brake pedal when the hill holder is activated and the vehicle is stationary
- the vehicle is stationary for approximately 9 minutes with the engine running and a gear selected
- you select the reverse gear
- you shift the ignition lock to the **0** position or remove the key when the frequent-stop brake is activated and the parking brake is released
- you exceed the maximum permissible engine speed
- the speed or engine speed is too high when making a gear change
- the loading platform approach aid detects that an obstacle is too close
- the hazard warning lamps are activated automatically (e.g. full brake application)

A warning tone sounds in addition to the event window appearing in the display of the on-board computer, if:

- the distance control assistant warns you that there is a risk of collision with the vehicle in front
- Active Brake Assist is activated and there is a risk of collision
- the coolant level is too low or the permissible coolant temperature (approximately 112 °C) is exceeded. The operating safety of the engine is jeopardised by this.
- there is a risk of overloading the clutch
- crawler mode has reached its operating limits and is automatically cancelled
- the sensor-monitored semitrailer coupling is not engaged or the semitrailer is no longer detected
- the tyre pressure monitor displays a tyre pressure loss warning
- you are driving faster than approximately 40 km/h with the shunting level activated.
- the instrument cluster and/or the on-board computer is malfunctioning. Important operating information, maintenance information or indicator and warning lamps can no longer be displayed

Refuelling

Fuel/AdBlue® tank

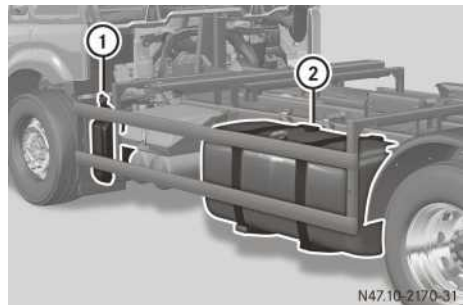

Fuel/AdBlue® tank (example: platform truck)

- ① AdBlue® tank
- ② Fuel tank

Fuel

Important safety notes

WARNING

Fuels are poisonous and hazardous to health. There is a danger of injury.

Do not swallow fuel or let it come into contact with skin, eyes or clothing. Do not inhale fuel vapours. Keep fuels out of the reach of children.

If you or others come into contact with fuel, observe the following:

- Wash the fuel off any affected areas of skin with water and soap immediately.
- If you get fuel in your eyes, rinse them thoroughly with clean water immediately. Seek immediate medical attention.
- If fuel is swallowed, seek immediate medical attention. Do not induce vomiting.
- Change any clothing that has come into contact with fuel immediately.

WARNING

Fuel is highly flammable. When fuel is handled improperly, there is a risk of fire and explosion.

Avoid fire, naked flames, smoking and the creation of sparks. Make sure that fuels do not come into contact with a hot exhaust system. Before carrying out work on the fuel system, switch off the ignition and the auxiliary heater. Always wear protective gloves.

WARNING

If you mix diesel fuel with petrol, the flash point of this fuel mixture is lower than that of pure diesel fuel. When the engine is running, components in the exhaust system may over-heat unnoticed. There is a risk of fire.

Never refuel with petrol. Never add petrol to diesel fuel.

i BlueTec®6 vehicles: refuel only with commercially available sulphur-free diesel fuel according to the European standard EN 590 as of 2010 with max. 0.001 wt% (10 ppm) sulphur content.

The following fuel types are not permitted:

- sulphurous fuel with a sulphur content over 0.001 wt%
- marine diesel fuel
- aviation turbine fuel
- heating oils
- fatty acid methyl ester FAME (bio-diesel fuel)²

These fuel types cause irreversible damage to the engine and BlueTec®6 exhaust gas after-treatment, as well as also significantly reducing the expected service life.

i BlueTec®4 vehicles and BlueTec®5 vehicles: the diesel fuel must comply with the European standard EN 590. This enables the engines to attain the specified performance as well as legally prescribed emission levels of the Euro 4 and Euro 5 standards.

The use of fuels with a sulphur content over 0.005 wt% (50 ppm) reduces the life expectancy of the engine and exhaust system.

The following fuel types are not permitted:

- sulphurous fuel with a sulphur content over 0.05 wt% (500 ppm)
- marine diesel fuel
- aviation turbine fuel

- heating oils
- FAME fatty acid methyl ester (bio-diesel fuel) > 7% by volume

i Vehicles without BlueTec® exhaust gas aftertreatment: refuel only with commercially available sulphur-free diesel fuel that conforms to the European standard EN 590 as of 2010 or a comparable national fuel standard.

This enables the engines to attain the specified performance as well as legally prescribed emission levels of the Euro -3 standard.

The following fuel types are not permitted:

- OM 460: sulphurous fuel with a sulphur content over 0.2 wt% (2000 ppm)
- OM 473: sulphurous fuel with a sulphur content over 0.1 wt% (1000 ppm)
- marine diesel fuel
- aviation turbine fuel
- heating oils
- FAME fatty acid methyl ester (bio-diesel fuel) > 7% by volume

! Do not use petrol to refuel vehicles with a diesel engine. Even small amounts of petrol result in damage to the fuel system and engine.

! Do not switch on the ignition if you accidentally refuel with the wrong fuel. Otherwise, the fuel will enter the fuel lines. Notify a qualified specialist workshop and have the fuel tank and fuel lines drained completely.

! Do not add any special fuel additives to the diesel fuel or fatty acid methyl ester FAME fuel.

Special fuel additives can lead to:

- malfunctions
- damage to the catalytic converter
- engine failure

Environmental note

If fuels are handled improperly, they pose a danger to persons and the environment. Do not allow fuels to run into the sewage system, the surface waters, the ground water or into the ground.

² Except for vehicle code (M0W).

! Use truck fuel pump nozzles to refuel. If you use a passenger vehicle fuel pump nozzle, the flap in the filler neck could be damaged.

If you have to use a passenger vehicle fuel pump nozzle, insert it into the filler neck so that only one of the pump nozzle lugs rest on the edge of the filler neck.

If a passenger vehicle fuel pump nozzle is inserted too far, this may result in a lug getting caught on the flap in the filler neck. To release the fuel pump nozzle in such a case, twist or tip it before attempting to remove the fuel pump nozzle.

You will find further information on fuel in the "Service products" section (▷ page 422).

Filling order

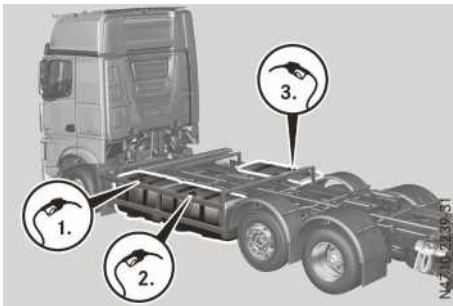

In vehicles with an additional fuel tank, you must observe the filling order. The fuel gauge otherwise does not correctly show the current fuel level, or the on-board computer the correct range.

- ▶ First, fill up the first fuel tank (main tank) on the left-hand side of the vehicle, directly behind the cab.
- ▶ When the main tank has been completely filled, then fill up the additional fuel tank on the left-hand side of the vehicle.
- ▶ Only when all tanks on the left-hand side of the vehicle have been completely filled, fill the additional fuel tank on the right-hand side of the vehicle.

When the main tank has run dry, the on-board computer displays a corresponding **Fully refuel the main tank first** message in the grey event window.

Before filling the tank

! If you are using drums or canisters to refuel the vehicle, you should filter the fuel before adding it.

This will prevent malfunctions in the fuel system due to contaminated fuel.

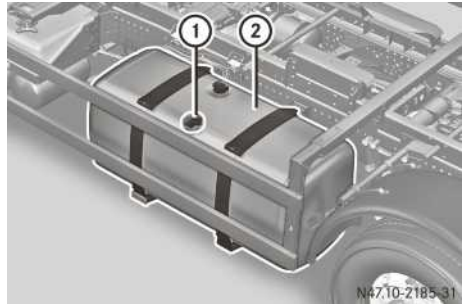

Fuel tank (example: single tank)

- ▶ Switch off the engine.
- ▶ Apply the parking brake.
- ▶ Switch off the auxiliary heating (▷ page 125).
- ▶ Remove the key from the ignition lock.
- ▶ Observe the filling order (▷ page 317).
- ▶ Unlock cap ① on fuel tank ② with the mechanical key element.
- ▶ Observe the fuel grade (▷ page 422).

i Regularly check the fuel prefilter with heated water separator for condensation (▷ page 378).

Folding ladder (Arocs road sweeper)

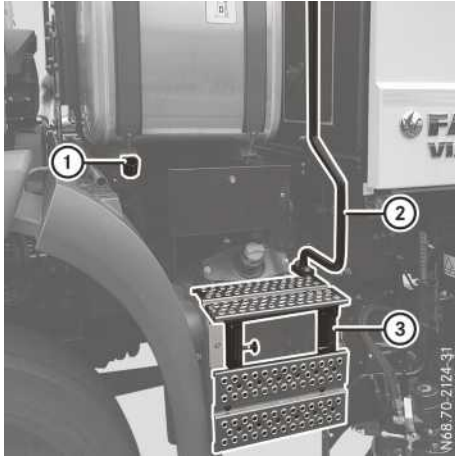

- ① Holder for fuel pump nozzle
- ② Grab handle
- ③ Folding ladder

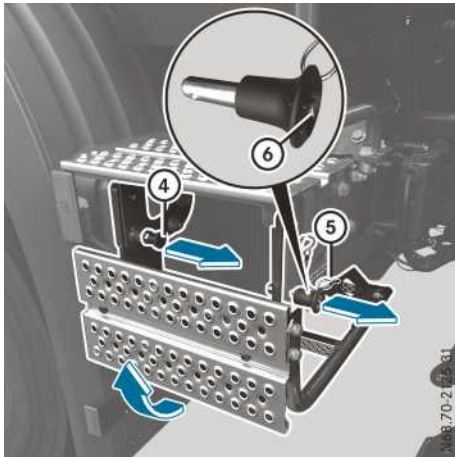

- ④ Locking mechanism
- ⑤ Detachable locking mechanism
- ⑥ Release knob

When refuelling the vehicle, use folding ladder ③ and grab handle ②.

Use folding ladder ③ only when it is fully folded out and both locking mechanisms are engaged.

- ▶ **To fold out and lock:** press release knob ⑥ on detachable locking mechanism ⑤ and detach the locking mechanism.
- ▶ Pull locking mechanism ④ from the catch and hold it.
- ▶ Fold out the ladder in the direction of the arrow.
- ▶ Once the ladder is folded out, engage locking mechanism ④ in the catch.
- ▶ Press detachable locking mechanism ⑤ into the catch and let it engage.
- ▶ **To fold in and lock:** press release knob ⑥ on detachable locking mechanism ⑤ and detach the locking mechanism.
- ▶ Pull locking mechanism ④ from the catch and hold it.
- ▶ Fold in the ladder.
- ▶ Engage locking mechanism ④ in the catch.
- ▶ Press detachable locking mechanism ⑤ into the catch and let it engage.

AdBlue®

Important safety notes

- ⚠ Do not allow diesel fuel to run into the AdBlue® tank. This could damage the BlueTec® exhaust gas aftertreatment.
- ⚠ Only use AdBlue®/DEF in accordance with DIN 70070/ISO 2224 1. Do not use any additives.
If AdBlue®/DEF comes into contact with painted or aluminium surfaces when filling the tank, rinse the affected area immediately with plenty of water.
- ⚠ Do not mix additives with AdBlue®. Do not dilute AdBlue® with tap water. This could destroy the BlueTec® exhaust gas aftertreatment system.
- ⚠ Always close the AdBlue® tank properly. Otherwise, impurities could enter the BlueTec® exhaust gas aftertreatment and damage it.
- ⚠ Make sure that you do not overfill the AdBlue®/DEF tank. Otherwise, the AdBlue®/DEF tank could be damaged at very low temperatures.

When opening the AdBlue® tank, small amounts of ammonia vapours could escape.

Ammonia vapours have a pungent smell and are particularly irritating to:

- skin
- mucous membranes
- eyes

The vapours may cause a burning sensation in the eyes, nose and throat as well as irritation of the throat and watering eyes.

Avoid inhaling ammonia vapours. Only fill the AdBlue® tank in well-ventilated areas.

AdBlue® should not come into contact with skin, eyes or clothing, and should not be swallowed. Keep AdBlue® out of the reach of children.

If you come into contact with AdBlue®, observe the following:

- Immediately wash AdBlue® from your skin with water and soap.
- If AdBlue® comes into contact with your eyes, rinse your eyes with clean water immediately. Consult a doctor without delay.
- If you have swallowed AdBlue®, immediately rinse your mouth with water and drink plenty of water. Consult a doctor without delay.
- Change clothing that is soiled with AdBlue® immediately.

AdBlue® is not refilled as part of the maintenance work. Therefore, top up the tank regularly during vehicle operation or at the latest when the first event message is displayed in the on-board computer.

You will find further information on AdBlue® in the "Service products" section (▷ page 425).

Before filling the tank

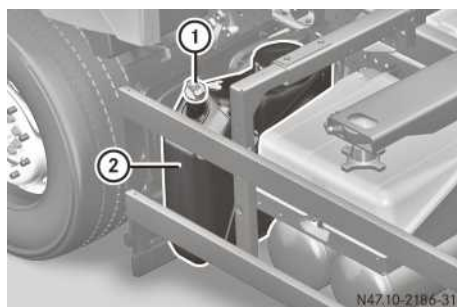

AdBlue® tank (example: single tank)

You can recognise AdBlue® tank (2) by blue cap (1). If AdBlue® tank (2) still contains sufficient AdBlue®, pressure compensation may result when unscrewing cap (1). AdBlue® may spill out. For this reason, take care when unscrewing cap (1) from AdBlue® tank (2). If AdBlue® spills out, immediately wash the affected area with plenty of water.

A special tank filler neck prevents AdBlue® tank (2) from mistakenly being filled with diesel fuel.

- ▶ Switch off the engine.
- ▶ Apply the parking brake.
- ▶ Switch off the auxiliary heating system (▷ page 125).
- ▶ Unlock cap (1) on AdBlue® tank (2) with the separate key.

i Depending on the vehicle's equipment cap (1) of AdBlue® tank (2) can be locked for security reasons.

Always refuel with at least 10% of the AdBlue® reservoir capacity. Topping up with smaller amounts could result in malfunctions.

Trailers/semitrailers

Notes about the trailer/semitrailer coupling

The trailer or semitrailer coupling is one of the vehicle components with particular importance for road safety. Please comply precisely with the manufacturer's operating, care and maintenance instructions.

If you fit a trailer coupling, observe the body/equipment mounting directives.

If your semitrailer tractor vehicle is equipped with a coupling ramp/coupling aid, the inclination angle specified in ISO 1726 cannot be guaranteed for all semitrailer coupling dimensions. Note that the clearance between the semitrailer tractor vehicle and the semitrailer may be restricted, and you should adapt your driving style accordingly. Always remove the mudguard centre sections before coupling up.

Driving tips for trailers/semitrailers

General notes

! Always observe the following safety instructions for driving with trailers and semitrailers:

- only attach a trailer/semitrailer at an appropriate trailer/semitrailer coupling.
- ensure there is adequate clearance between the trailer/semitrailer and the tractor vehicle.
- if the vehicle is being driven without a load, only a trailer without a load may be coupled up.
- do not exceed the permissible axle loads.
- adhere to a minimum front axle load. This ensures adequate steerability for the tractor vehicle.

Minimum front axle load – tractor vehicle:

25% = three-axle vehicle

30% = two-axle vehicle (trailer lighter or as heavy as the tractor vehicle)

35% = two-axle vehicle (trailer heavier than the tractor vehicle)

i On vehicles with pneumatic suspension and axle load indicators, the current axle loads can be called up on the on-board computer (▷ page 143).

! If you drive with more than two trailers/semitrailers, you must switch off Stability Control Assist. Otherwise, malfunctions or faults can occur as a result.

Deactivating/activating Stability Control Assist (▷ page 267).

Articulation angles

! If the articulation angle is exceeded, the tractor vehicle and the trailer/semitrailer can be damaged.

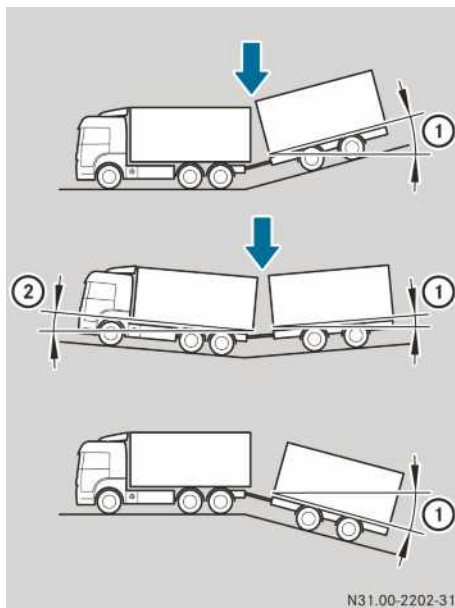

N31.00-2202-31

Example: tractor vehicle and centre-axle trailer

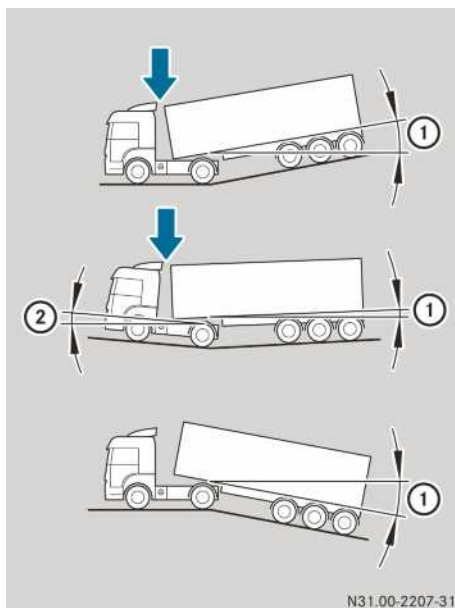

N31.00-2207-31

Example: tractor vehicle and semitrailer

► When driving over depressions or elevations, please be aware that the articulation angle at front ② or rear ① changes.

i If the tractor/trailer combination jack-knives, the clearance between the tractor vehicle and the trailer/semitrailer is reduced.

The articulation angles are dependent on the particular tractor vehicle and trailer or semitrailer. They are affected by:

- wheelbase
- height of add-on equipment
- overhang
- distance from the tractor vehicle to the trailer or semitrailer

Swivel angle

WARNING

If the swivel angle is exceeded during extreme cornering, the following can happen:

- the cable, compressed-air and hydraulic lines may break away
- the trailer tow hitch and the trailer drawbar may be damaged

This could cause you to lose control of the vehicle or the trailer. The trailer may even break away. There is a risk of an accident.

Always pay attention to the swivel angle of the vehicle combination when cornering.

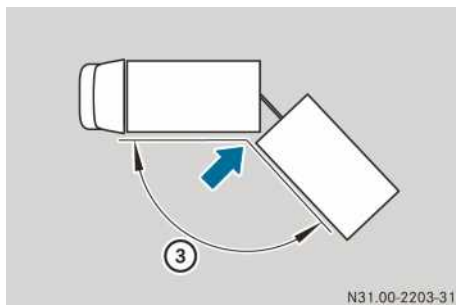

N31.00-2203-31

Example: tractor vehicle and centre-axle trailer

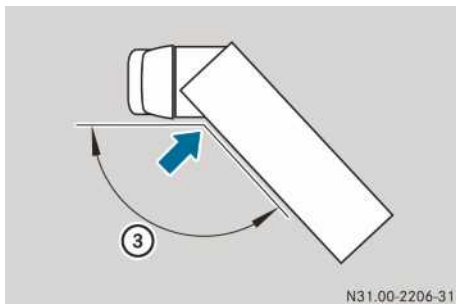

N31.00-2206-31

Example: tractor vehicle and semitrailer

► Pay attention to swivel angle ③ during extreme cornering.

The swivel angle is dependent on the coupling system on the tractor vehicle and trailer or semitrailer.

Coupling up

Note on tractor/trailer synchronisation (vehicles without EBS)

! Tractor/trailer synchronisation should be carried out when you couple up/attach a trailer or semitrailer to the tractor vehicle for the first time. Not doing so could lead to increased brake wear. Always have tractor/trailer synchronisation carried out at a qualified specialist workshop.

Information on semitrailer coupling

Important safety notes

WARNING



If the semitrailer coupling is damaged or not correctly engaged, you could lose the semitrailer. There is a risk of an accident.

Always check that the semitrailer coupling is free of damage and properly engaged after coupling-up.

This should also be checked if:

- your vehicle is equipped with a sensor-monitored semitrailer coupling and
- the  indicator lamp in the status area of the on-board computer lights up green

Sensor-monitored semitrailer coupling

 If the red  **Check semitrailer coupling and open if required** event window is displayed by the on-board computer when coupling up, you could damage the sensor-monitored semitrailer coupling and the semitrailer coupling pin. Check the locking mechanism on the sensor-monitored semitrailer coupling.

 Observe the wear limits specified in the manufacturer's operating instructions for the:

- wear ring
- locking hook
- semitrailer coupling pin

Ensure that the parts do not fall below the wear limits. Otherwise, the sensor on the semitrailer coupling pin can be damaged.

If a red event window appears several times in the on-board computer display when a semitrailer is coupled up and the ignition is switched on, check the wear limits:

- on the semitrailer
- on the sensor-monitored semitrailer coupling

The sensor-monitored semitrailer coupling has sensors which, during the attaching/detaching process or once the ignition has been switched on, perform the following:

- monitor the semitrailer, the semitrailer coupling pin and the clasp
- display the status of the locking mechanism of the sensor-monitored semitrailer coupling in the display of the on-board computer

If malfunctions or faults occur during coupling/decoupling, the on-board computer displays a red event window (▷ page 180).

Indicator lamps in the status area of the on-board computer and their meaning:



red

The semitrailer is not coupled up. The sensor-monitored semitrailer coupling is not engaged.



red

The semitrailer is not correctly coupled up. The sensor-monitored semitrailer coupling is engaged, however no semitrailer can be detected.



green

The semitrailer is correctly coupled up. Check that the sensor-monitored semitrailer coupling is in good condition and engaged correctly.



red

The sensor monitoring of the semitrailer coupling is malfunctioning. Observe the additional information in the red event window of the on-board computer.

Semitrailers

WARNING

If there is too much play on the tractor/semitrailer combination between the semitrailer coupling pin and the coupling plate, the semitrailer may break away from the coupling plate. You could lose the semitrailer as a result. There is a risk of an accident.

Follow the coupling manufacturer's instructions.

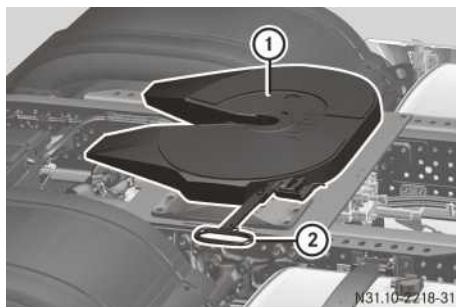

Example: semitrailer coupling

For vehicles with a sensor-monitored semitrailer coupling, observe the information on the attaching/detaching procedures in the manufacturer's operating instructions.

Before coupling up:

- ▶ Chock the semitrailer's wheels to prevent it from rolling away.
- ▶ Open semitrailer coupling ① with lever ②; see the manufacturer's operating instructions.
- ▶ Semitrailer tractor vehicles with air suspension: raise or lower the chassis frame (▷ page 297) so that the semitrailer plate is 50 mm lower than semitrailer coupling ①.
- ▶ Steel sprung vehicles: use the saddle supports to set the height of the semitrailer so that the semitrailer plate is 50 mm lower than semitrailer coupling ①.

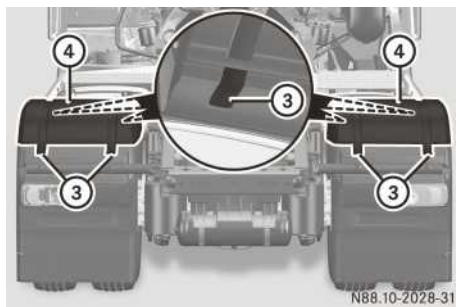





Only remove mudguard centre parts ④ if:

- the semitrailer makes the use of mudguard centre parts ④ impossible and
 - the semitrailer's body covers the wheels
- When using mudguard centre parts ④, observe the legal requirements for the country you are currently in.

- ▶ Release rubber retainers ③ of mudguard centre parts ④ on the left and the right-hand side of the vehicle.
- ▶ Remove mudguard centre parts ④.

Coupling up with vehicles with a sensor-monitored semitrailer coupling:

- ▶ Drive slowly under the semitrailer plate.
- ▶ Raise the vehicle level or lower the semitrailer until the on-board computer displays the grey  **Coupling level reached** event window.
- ▶ Back up slowly until semitrailer coupling ① locks.
The  indicator lamp in the status area of the on-board computer lights up green.
- ▶ If the on-board computer displays the red  **Driving level below coupling level** event window when reversing, correct the coupling level again until the on-board computer displays the grey  **Coupling level reached** event window.

Coupling up vehicles without a sensor-monitored semitrailer coupling:

- ▶ Back up slowly until semitrailer coupling ① locks.

After coupling up:

- ▶ Stop the vehicle and apply the parking brake.
- ▶ Secure semitrailer coupling ① against unauthorised operation and check the locking mechanism; see the manufacturer's operating instructions.
- ▶ Retract the saddle supports fully; see the manufacturer's operating instructions.
- ▶ Connect the cable and compressed-air lines (▷ page 324).

Tractor/trailer combination

WARNING

If the trailer coupling has too much longitudinal play, the trailer can tear away. You could lose the semitrailer as a result. There is a risk of an accident.

Check the trailer coupling daily for longitudinal play by moving the towbar body of the trailer coupling forwards and back firmly. Have any longitudinal play eliminated at a

qualified specialist workshop as soon as possible.

Longitudinal play cannot be checked at the coupling jaw.

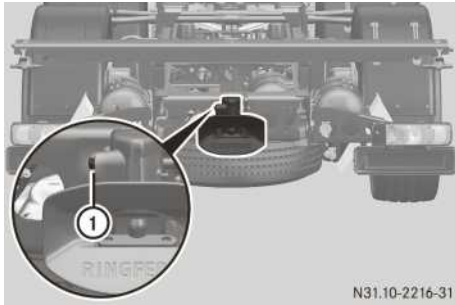

Example: securing knob

Before coupling up:

- ▶ Apply the parking brake and release the service brake of the trailer; see the manufacturer's operating instructions.
- ▶ Chock the trailer's rear wheels to prevent it from rolling away.
The unbraked front axle of the trailer must remain pivotable.
- ▶ Set the towbar supports to the height of the trailer coupling; see the manufacturer's operating instructions.

Coupling up:

- ▶ Back up slowly until the trailer coupling locks.

After coupling up:

- ▶ Check that the coupling pin on securing knob ① is in the correct position or check the control pin of the trailer coupling.
- ▶ Connect the cable and compressed-air lines (▷ page 324).

Uncoupling

! Semitrailer tractor vehicles with air suspension: before completely uncoupling, lower the chassis frame until there is a gap between the semitrailer plate and the semitrailer coupling. Otherwise, the chassis frame will spring up suddenly when uncoupling. This can cause damage to the chassis frame and the semitrailer.

- ▶ Park the vehicle on a firm and level surface.
- ▶ Apply the parking brake.
- ▶ Chock the trailer/semitrailer's wheels to secure it against rolling away.
- ▶ Extend the saddle supports of the semitrailer; see the manufacturer's operating instructions.
- ▶ Set the trailer's towbar support to the height of the trailer coupling; see the manufacturer's operating instructions.
- ▶ Remove the cable and compressed-air lines (▷ page 324).
- ▶ Open the trailer coupling/semitrailer coupling; see the manufacturer's operating instructions.

Vehicles with a trailer:

- ▶ Drive forwards slowly.

Vehicles with a semitrailer:

- ▶ Drive slightly forward until the semitrailer coupling pin is free.
- ▶ Semitrailer tractor vehicle with air suspension: lower the chassis frame (▷ page 297) until there is a gap between the semitrailer plate and the semitrailer coupling.
- ▶ Drive forwards completely.
- ▶ Fit the mudguard centre part.

Cables and compressed-air lines

Important safety notes

WARNING

If you climb onto or down from the vehicle in order to connect/disconnect the cables and compressed-air lines without appropriate climbing aids, you could:

- slip and/or fall
- damage components, e.g. the battery cover, and fall as a result
- burn yourself on hot components

There is a risk of injury.

Always use secure climbing aids, e.g. a suitable ladder.

⚠ WARNING

The cover of the silencer can get very hot when driving. You could burn your foot if, for example, you step on this cover in order to connect/disconnect the cables and compressed-air lines. There is a risk of injury. Never step on the cover of the silencer.

General notes

When operating additional consumers on your trailer/semitrailer, make sure that no overloading occurs. If you fit several reversing lamps on the trailer/semitrailer, for example, the reversing lamps may fail as a result of overloading.

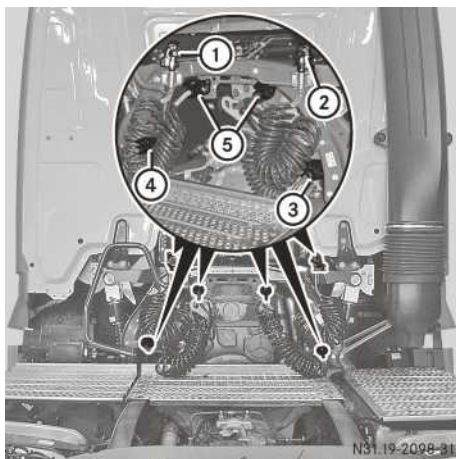
Arrangement of connections

Connections for semitrailer (example: semitrailer tractor vehicle)

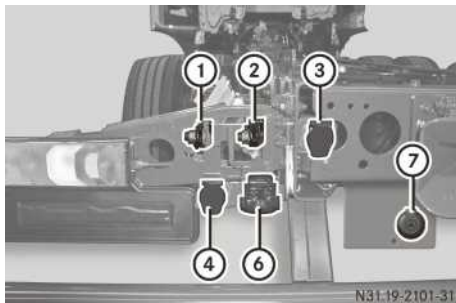

Connections for trailer (example: platform truck)



Example: duomatic coupling, front

Connecting cables and compressed-air lines

! Arrange the cables and compressed-air lines in such a way that they easily yield to all movements without tension, kinking or friction when cornering, etc. Before connecting the cable, make sure the voltage rating of the consumer equipment on the trailer is correct.

- ▶ With dual coupling head: push down and hold the lever at dual coupling head ⑥.
- ▶ With dual coupling head: connect the compressed-air lines.
- ▶ With dual coupling head: swing upwards and release the lever at dual coupling head ⑥.
- ▶ Without dual coupling head: connect brake line coupling head ① (yellow).
- ▶ Without dual coupling head: connect supply line coupling head ② (red).

i The shutoff valves in the coupling heads open automatically when the connection is made.

- ▶ Trailers with adjustable brake-pressure regulator: adjust the brake-pressure regulator on the trailer after connecting the compressed-air line (see the trailer operating instructions).
- ▶ Semitrailer tractor vehicle: connect 24 V (15 pin) power supply plug ④ to the trailer.
- ▶ Platform truck: connect the power supply of the trailer to 24 V (15 pin) socket ④.

i On trailers with a 12 V power supply: use 12 V (13 pin) trailer power socket ⑦.

i Turn signal monitoring is also active when using LED tail lamps. A system failure is indicated by the lamps flashing at double the frequency or by a display message in the driver information system.

- ▶ Semitrailer tractor vehicle: connect ABS/BS (5/7 pin) connecting cable plug ③ to the trailer.
- ▶ Platform truck: attach the connecting cable from the trailer to ABS/BS (5/7 pin) socket ③.
- ▶ Semitrailer tractor vehicles: if the semitrailer tractor vehicle is being driven with a semitrailer without ABS, insert the plug of the connection cable into empty socket ⑤.
- ▶ Check lighting systems, turn signals and brake lamps on the vehicle and on the trailer/ semitrailer for correct functioning and cleanliness.
- ▶ Check the operation of the indicator lamps for the towing vehicle and trailer/ semitrailer turn signals in the instrument cluster.
- ▶ After pulling away, check that the brake circuit on the trailer/ semitrailer is functioning correctly, paying attention to the road and traffic conditions.
- ▶ With dual coupling head: push down and hold the lever at dual coupling head ⑥.
- ▶ With dual coupling head: remove the compressed-air lines.
- ▶ With dual coupling head: swing upwards and release the lever at dual coupling head ⑥.
- ▶ Without dual coupling head: disconnect supply line coupling head ② (red). The brakes of the trailer/ semitrailer will be applied automatically.
- ▶ Without dual coupling head: remove brake line coupling head ① (yellow).
- ▶ Semitrailer tractor vehicle: disconnect 24 V (15 pin) power supply plug ④ from the trailer.
- ▶ Platform truck: disconnect the power supply of the trailer at the towing vehicle from 24 V (15 pin) socket ④.
- ▶ **i** On trailers with a 12 V power supply: disconnect the power supply of the trailer at the towing vehicle from 12 V (13 pin) socket ⑦.

Disconnecting cables and compressed-air lines

WARNING

If you remove the coupling heads in the wrong order, the trailer/ semitrailer brake is released and the trailer/ semitrailer may roll away. There is a risk of an accident.

Always detach the coupling heads in the correct order.

- ▶ **i** After disconnecting the compressed-air lines, ensure that the covers of the coupling heads on the vehicle are closed. If the covers are not closed, the coupling heads may become contaminated, causing a malfunction.
- ▶ **i** After you have disconnected the cables, make sure you insert the plugs in the sockets. If you do not insert the plugs in the sockets, water may get into the cable harness and damage the electrical system.
- ▶ Apply the parking brake of the tractor vehicle.
- ▶ Apply the parking brake of the trailer/ semitrailer. Observe the manufacturer's operating instructions.

- ▶ Semitrailer tractor vehicle: disconnect ABS/BS (5/7 pin) connecting cable plug ③ from the trailer.
- ▶ Platform truck: disconnect the connecting cable from the trailer at the towing vehicle from ABS/BS (5/7 pin) socket ③.
- ▶ Semitrailer tractor vehicle: when driving the semitrailer tractor vehicle without the semitrailer, insert the connecting cable into empty socket ⑤.
- ▶ Check the operation and cleanliness of the lighting system as well as that of the turn signals and brake lamps.

Semitrailer tractor vehicle hydraulic system

Important safety notes

WARNING

The hydraulic system is under high pressure and the hydraulic fluid may be hot. If work on the hydraulic system is carried out incorrectly, high-pressure hydraulic fluid may spray out. There is a risk of injury.

Only have work on the hydraulic system carried out at a qualified specialist workshop.

⚠ WARNING

If you drive off with the tipper body raised, it could get caught on buildings, bridges or trees, for example. There is a risk of an accident.

Before pulling away, always ensure that the tipper body is lowered and properly secured.

! Different types of hydraulic fluid are rarely compatible although they are mixed from the same oil base. Mixing hydraulic fluid types always affects their characteristics, performance and reactions. You must not mix the semi-trailer hydraulic system's hydraulic fluid. The hydraulic fluid for the trailer hydraulic system must therefore match the hydraulic fluid for the semi-trailer hydraulic system. Otherwise, it can result in damage to the semi-trailer hydraulic system.

! Observe the following instructions for operating the semi-trailer hydraulic system:

- the semi-trailer hydraulic system's operating pressure must not exceed the maximum permitted operating pressure for the trailer hydraulic system
- the tipper semi-trailer's hydraulic lines must be connected
- the low-speed splitter group must be activated

Otherwise, the semi-trailer hydraulic system and/or the trailer hydraulic system may be damaged.

General notes

If using the semi-trailer hydraulic system, you may only operate tipper semi-trailers with a one or two line system. You operate their hydraulic system with a pick-up valve in the driver's cab. The semi-trailer hydraulic system's operating pressure is switchable between 170 bar (low pressure) and 250 bar (high pressure).

The hydraulic line connections have screw couplings of either 1 inch or DN 20.

The semi-trailer hydraulic system is filled at the factory with a hydraulic fluid from HLP (HLP-D 22) (▷ page 330).

Before operating a tipper semi-trailer, be sure that:

- the semi-trailer hydraulic system's operating pressure does not exceed the maximum permitted operating pressure for the trailer hydraulic system
- the hydraulic connections of both hydraulic systems are compatible
- the trailer hydraulic system's hydraulic fluid matches that of the semi-trailer hydraulic system

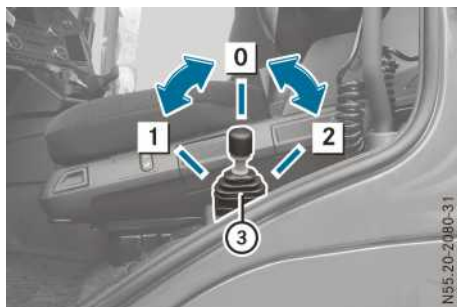
Controls**Pick-up valve in the driver's cab**

- 1 Lower tipper body
- 0 STOP – stop the tipping or lowering movement
- 2 Raise tipper body
- 3 Control lever with pull ring

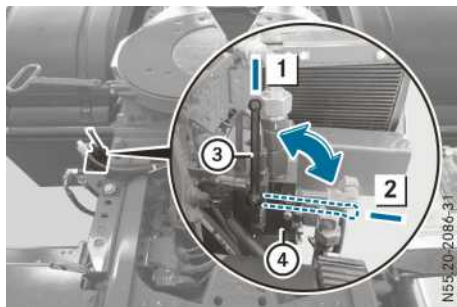
Tipper valve with changeover unit on the chassis

- 1 Operating position low pressure (LP) 170 bar
- 2 Operating position high pressure (HP) 250 bar

- ③ Operating lever
- ④ Tipper valve

Hydraulic connections

Connecting or disconnecting hydraulic lines

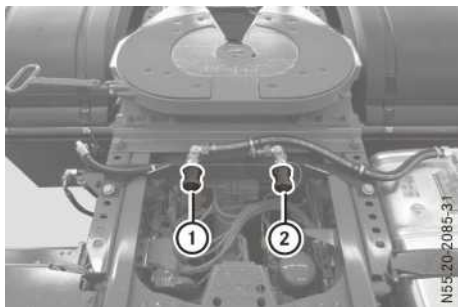

Keep the hydraulic lines such that they can manage all movements when cornering etc. without tensioning, kinking or rubbing. Before connecting the hydraulic lines be sure that their screw couplings are compatible with the sockets on the towing vehicle. Do not use any tools when connecting the hydraulic lines and do not climb on any part of the vehicle.

Before coupling and decoupling the hydraulic lines, the semi-trailer hydraulic system must be depressurised and the trailer's tipper body should be fully lowered. The semi-trailer hydraulic system is only depressurised if the control lever in the driver's cab is in the centre position (STOP) and power take-off is disengaged. A few drops of hydraulic fluid may escape when separating the hydraulic connections. Observe the national work safety and accident prevention regulations as well as the environmental protection regulations.

If the tipper semi-trailer is fitted with a two-line system, connect the pressure line to connection ② and the return flow line to connection ①. If the return flow line is not coupled or coupled incorrectly, it can result in damage to the tipper semi-trailer's hydraulic system.

If the tipper semi-trailer is fitted with a one-line system, connect the hydraulic line to connection ② on your vehicle. Connection ① for the return line remains free in this case.

Connecting

- ▶ Make sure that the trailer hydraulic system's operating pressure matches that of the semi-trailer hydraulic system. Select the high or low pressure setting on the changeover unit for the operating pressure (▷ page 327).
- ▶ Ensure that the control lever in the driver's cab is in the central position (STOP) (▷ page 327).
- ▶ Ensure that power take-off for the hydraulic pump is switched off (▷ page 341).
- ▶ Loosen dust protection caps from the connections on the vehicle and from the hydraulic lines.
- ▶ Connect the hydraulic lines to the sockets and tighten them hand-tight.
- ▶ Run a function check after connecting the hydraulic lines.

Disconnecting

- ▶ Ensure that the control lever in the driver's cab is in the central position (STOP) (▷ page 327).
- ▶ Ensure that power take-off for the hydraulic pump is switched off (▷ page 341).
- ▶ Place a cloth or a suitable receptacle under each connection to take up the drops of hydraulic fluid.
- ▶ Loosen and disconnect the hydraulic lines on the connections.
- ▶ Fasten the dust protection caps on the connections on the vehicle and the hydraulic lines.
- ▶ Correctly dispose of collected hydraulic fluid.

Operating the hydraulic system

Tipping

- ▶ Engage power take-off for the hydraulic pump (▷ page 341). The chassis frame is lowered automatically. This increases stability. The display shows the  symbol for chassis frames below driving level.
- ▶ Ensure that the low-speed splitter group is selected.
- ▶ Pull up and hold the pull ring on the control lever in the driver's cab (▷ page 327).

Pull the control lever back gently. To stop the tipping movement, move the control lever into its centre position (STOP).

The further back you pull the control lever, the faster the tipping speed.

Indicator lamp  lights up in the display if the tipper body is raised.

or

- ▶ Pull the pull ring upwards and the control lever in the driver's cab back as far as it will go.

The control lever is engaged. The tipper body will stop tipping automatically after the control lever reaches its end point.

Indicator lamp  lights up in the display if the tipper body is raised.

- ▶ To stop the tipping movement, pull the pull ring upwards and put the control lever in the driver's cab into its centre position (STOP).

Lowering the tipper body

- ▶ When the control lever in the driver's cab is engaged in its end position, pull the pull ring upwards and put the control lever in the driver's cab into its centre position (STOP).

- ▶ Push the control lever forward gently. To stop the lowering movement, put the control lever into its centre position (STOP).

The further forward you push the control lever, the faster the speed of the lowering movement.

When the tipper body is fully lowered, the  indicator lamp goes out in the display.

- ▶ Put the control lever in the driver's cab into its centre position (STOP).
- ▶ Disengage power take-off (▷ page 341).
- ▶ Raise the chassis frame to driving level (▷ page 298).

Maintenance and care

Cleaning

Observe the notes:

- on cleaning the vehicle exterior (▷ page 349)
- on high-pressure cleaning (▷ page 353)

When cleaning the vehicle exterior, ensure that you never directly aim the water jet at the hydraulic fluid reservoir cover fitted with a vent filter.

Visual inspection

- ! Hydraulic hoses are marked with a use-by date (six years after the date of manufacture). Hydraulic hoses must be replaced by a specialist workshop at the end of this operating duration even if there is no visible damage to them.

Check the semi-trailer hydraulic system's components, and in particular the hydraulic leads, on a weekly basis for leaks, external damage and operating duration. Have defective and leaking components repaired immediately at a qualified specialist workshop.

Checking the hydraulic fluid level and topping up hydraulic fluid

Environmental note

When topping up the oil, take care not to spill any. If oil enters the soil or waterways, it is harmful to the environment.

- ! Do not top up too much hydraulic fluid. If you top up too much hydraulic fluid, the expansion chamber in the hydraulic fluid reservoir shrinks and the hydraulic system can be damaged. Have excess hydraulic fluid siphoned off.

Only use hydraulic fluid which has been checked and approved by the Mercedes-Benz Specification for Service Products for the semi-trailer hydraulic system. Using other hydraulic fluids or mixing other hydraulic fluids can damage the semi-trailer hydraulic system.

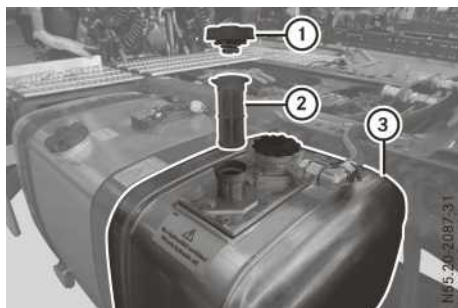

Hydraulic fluid reservoir (example combined fuel/hydraulic fluid reservoir)

Hydraulic fluid reservoir ③ is either a single tank on the right-hand side of the vehicle or as a combination tank with the fuel tank on the left-hand side of the vehicle.

Check the hydraulic fluid level every day and only when the vehicle is horizontal and stationary.

- ▶ Ensure that the control lever in the driver's cab is in the central position (STOP) (▷ page 327).
- ▶ Ensure that power take-off for the hydraulic pump is switched off (▷ page 341). Only then is the semi-trailer hydraulic system depressurised.
- ▶ Remove cover ① with integrated vent filter.
- ▶ Unscrew and remove screen filter ②.
- ▶ Measure the gap between the hydraulic fluid surface level and the upper edge of the filler neck and determine the quantity of fluid used.

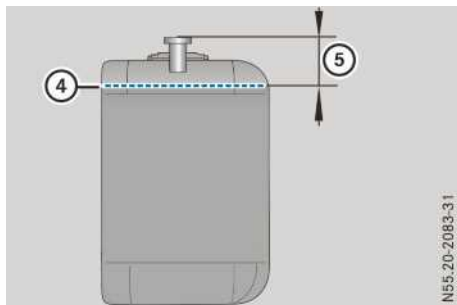

Combination tank with fuel tank on the left-hand side of the vehicle

④ Max. fill level	⑤ Distance
140 l for 128 l used fluid quantity (volume used)	120 mm
Approx. 2.3 l used oil loss per 10 mm lowering of the surface level	

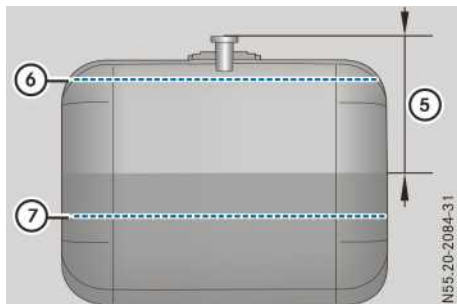

Single tank on the right-hand side of the vehicle

⑥ Max. fill level	⑤ Distance
226 l for 198 l used fluid quantity (volume used)	101 mm
⑦ Fill level	⑤ Distance
156 l for 128 l used fluid quantity (volume used)	258 mm
Approx. 4.5 l used fluid loss per 10 mm lowering of the surface level	

- ▶ If necessary, top up with an authorised hydraulic fluid through screen filter ②. Before topping up, screw the screen filter into the filler neck and then check the hydraulic fluid level again.
- ▶ Screw screen filter ② into the filler neck.
- ▶ Place cap with integrated vent filter ① on the filler neck and fasten tightly.

Replacing the hydraulic fluid reservoir cap

Replace the hydraulic fluid reservoir cap every year. In more dusty conditions you must change the cap with integrated vent filter even more regularly.

Parking up the vehicle

In addition to the special measures according to Mercedes-Benz Specifications for Service Products Sheet 382.0, a change of hydraulic fluid must be carried out. After a period out of use of more than 24 months a change of hydraulic fluid must be carried out before restarting operation.

Operating data

Hydraulic fluid quality

The semi-trailer hydraulic system is filled at the factory with year-round hydraulic fluid from HLP (HLP-D 22).

Only use authorised hydraulic fluid with part number A 000 989 10 06 according to the Mercedes-Benz Specification for Service Products Sheet Number 34 1.0.

Hydraulic fluid reservoir

Combination tank with fuel tank on the left-hand side of the vehicle	
Maximum tank content	140 l
Maximum used fluid quantity (usable volume)	128 l
Non-usable dead volume	12 l

Single tank on the right-hand side of the vehicle	
Maximum tank content	226 l
Maximum used fluid quantity (use volume)	198 l
Tank content for 128 l of fluid (usable volume)	156 l
Non-usable dead volume	28 l

i As a single tank, the hydraulic fluid reservoir is filled with 156 l of hydraulic fluid at the factory.

Operating pressure and fluid output

High pressure operation	250 bar
Low pressure operation	170 bar
Average fluid output At an engine speed of 1000 rpm and sufficient used fluid quantity	120 l/min
Max. permitted engine speed Maximum speed with low-range splitter group. Selecting the high-range splitter group is not permitted and can damage the hydraulic system.	1100 rpm

Hydraulic connections

The hydraulic line connections have screw couplings of either 1 inch or DN 20.

Loading platform approach aid

WARNING

The loading platform approach aid cannot detect persons or moving obstacles. There is therefore a risk of accident even with the loading platform approach aid activated.

Make sure that there are no persons or objects behind the vehicle in the area in which you are manoeuvring.

► To activate: reverse.

If the trailer/semitrailer is equipped with the loading platform approach aid, the on-board computer display shows the function automatically when reversing.

Depending on the loading platform approach aid, the distance from the trailer/semitrailer to the detected obstacle is also displayed, for example 2.30 m.

If the distance to the detected obstacle is less than approximately 1.80 m, the on-board computer displays the trailer/semitrailer symbol in red.

If the distance to the detected obstacle is less than approximately 0.70 m, a warning tone sounds.

Wind deflector

Setting

WARNING

There are no working surfaces fitted on the vehicle for adjusting the wind deflector. If you adjust the wind deflector yourself, there is a danger of falling. There is a risk of injury.

For this reason, use firm, non-slip working surfaces, e.g. a ladder. You must not stand on the roof.

WARNING

If you adjust the wind deflector, you could get trapped between parts of the wind deflector or between the wind deflector and the cab. There is a risk of injury.

When adjusting the wind deflector make sure that there is adequate clearance. Do not place

parts of your body between the wind deflector and the cab. Have a second person assist you.

Environmental note

When the wind deflector is adjusted correctly, the air resistance is lowered. This reduces fuel consumption.

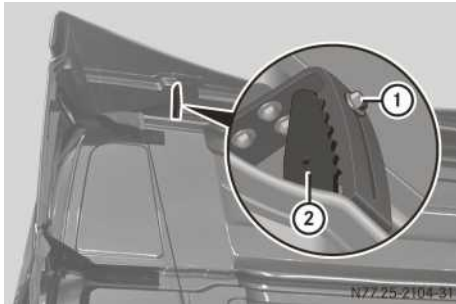

Example: wind deflector adjustment

Mercedes-Benz recommends that you have the wind deflector adjusted at a qualified specialist workshop.

When adjusting the wind deflector, make sure that you:

- do not exceed the permissible vehicle height (4 m for international transport)
 - observe the headroom clearance of underpasses
 - the legal requirements for the country you are currently in
- ▶ Determine which diagram corresponds to your vehicle.
- ▶ Measure clearance **S** between the rear wall and body.
- ▶ Measure height difference **H** between the drip rail and body.
- ▶ Identify adjustment detent **A** in the diagram with height difference **H**.
- ▶ Unscrew bolts ① on the adjustment rails on both sides of the vehicle.
- ▶ Using determined adjustment detent **A**, adjust the adjustment rails on holder ②.
- ▶ Screw in bolts ①.

Diagrams

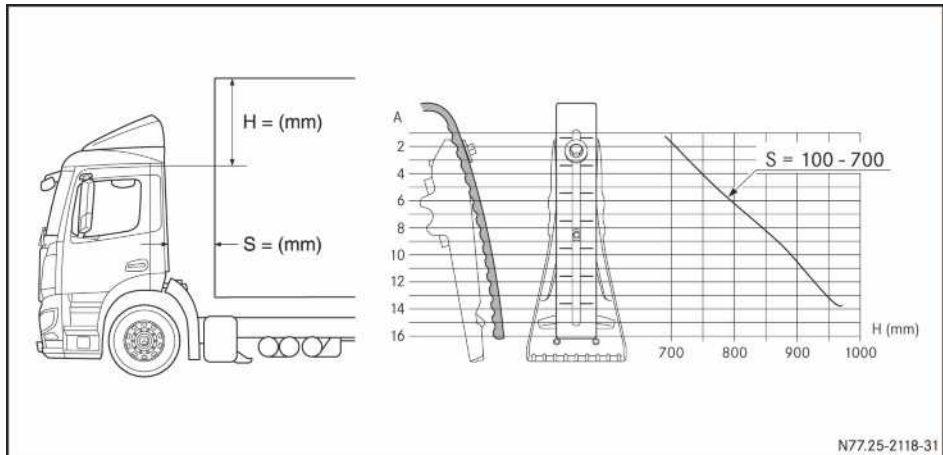

Example: semitrailer tractor vehicle/platform truck, ClassicSpace cab

S = 100 - 700 mm: semitrailer tractor vehicle/platform truck with ClassicSpace cab and an add-on height of 420, 600 or 765 mm

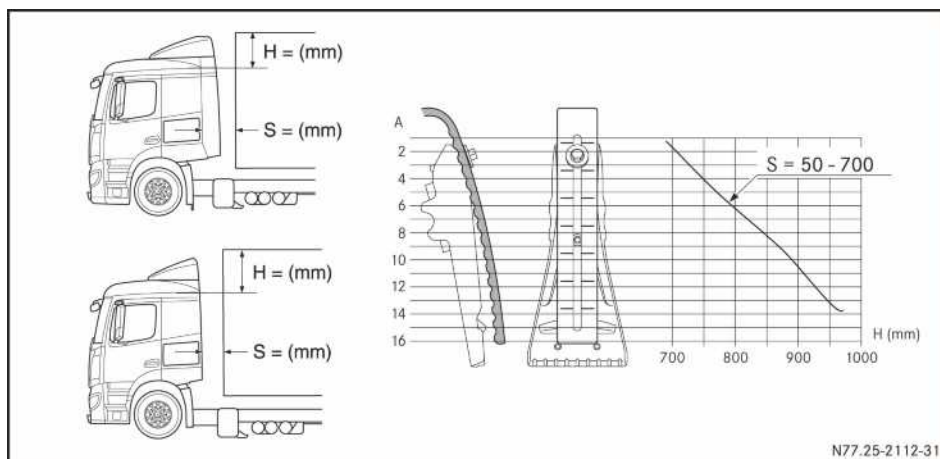

Example: semitrailer tractor vehicle/platform truck, CompactSpace cab

$S = 50 - 700$ mm: semitrailer tractor vehicle/platform truck with CompactSpace cab and an add-on height of 420, 600 or 765 mm

$S = 580 - 700$ mm: semitrailer tractor vehicle with CompactSpace cab, side air deflector and an add-on height of 420, 600 or 765 mm

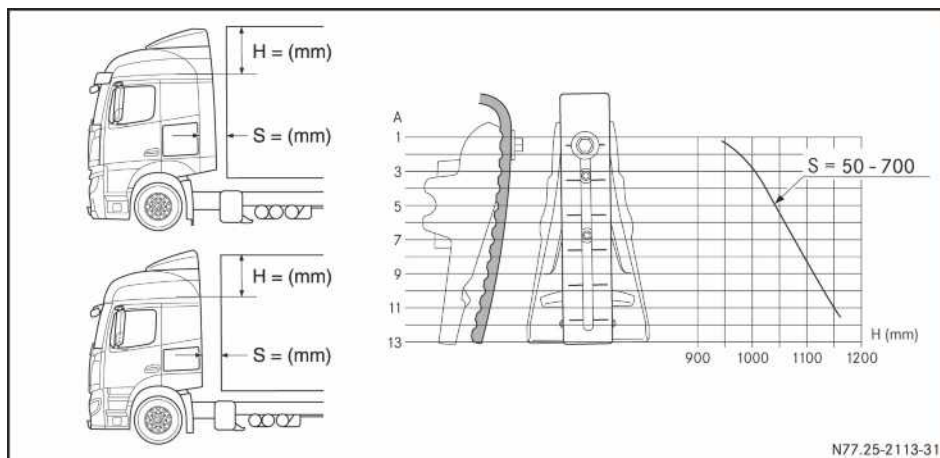

Example: semitrailer tractor vehicle/platform truck, StreamSpace cab

$S = 50 - 700$ mm: semitrailer tractor vehicle/platform truck with StreamSpace cab and an add-on height of 420 or 600 mm

$S = 580 - 700$ mm: semitrailer tractor vehicle with StreamSpace cab, side air deflector and an add-on height of 420 or 600 mm

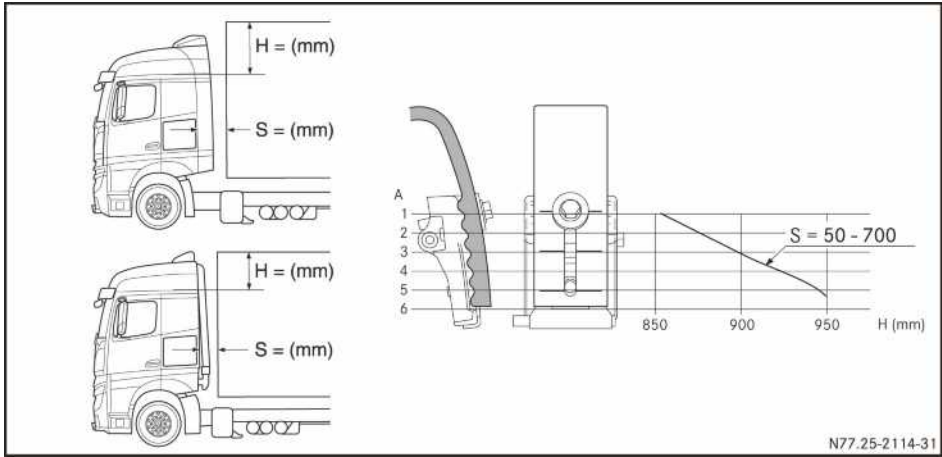

Example: semitrailer tractor vehicle/platform truck, StreamSpace cab

S = 50 - 700 mm: semitrailer tractor vehicle/platform truck with Stream or BigSpace cab and an add-on height of 765 mm, total vehicle height up to 4,060 mm

S = 580 - 700 mm: semitrailer tractor vehicle with Stream or BigSpace cab, side air deflector and an add-on height of 765 mm, total vehicle height up to 4,060 mm

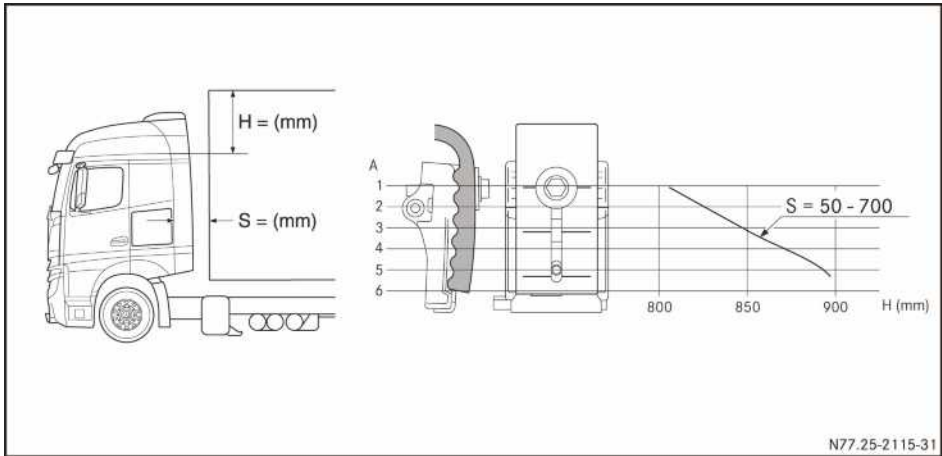

Example: semitrailer tractor vehicle, StreamSpace cab

S = 580 - 700 mm: semitrailer tractor vehicle with Stream or BigSpace cab, side air deflector and an add-on height of 765 mm

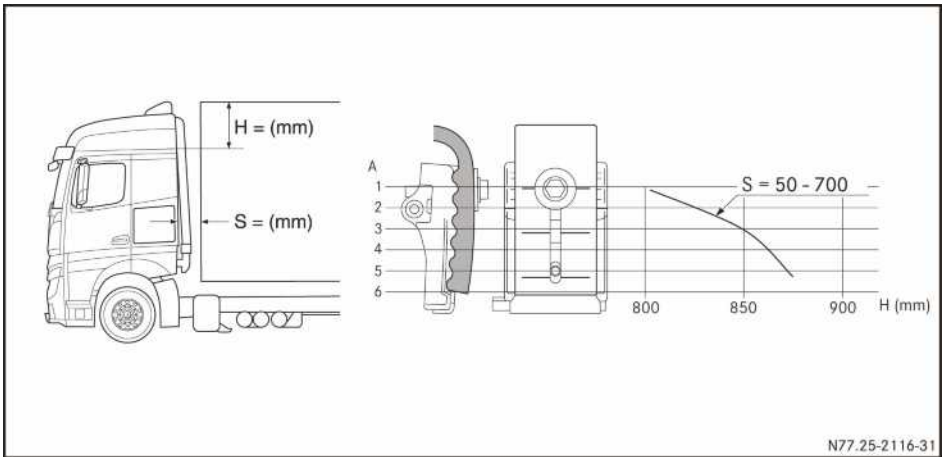

Example: platform truck, StreamSpace cab

$S = 50 - 700$ mm: semitrailer tractor vehicle with Stream or BigSpace cab and an add-on height of 765 mm

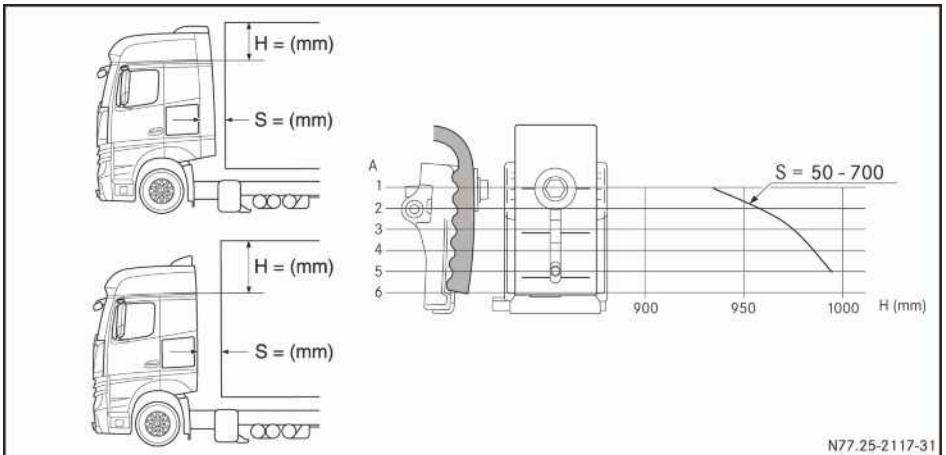

Example: semitrailer tractor vehicle/platform truck, GigaSpace cab

$S = 50 - 700$ mm: semitrailer tractor vehicle/platform truck with GigaSpace cab and an add-on height of 765 mm

$S = 580 - 700$ mm: semitrailer tractor vehicle/platform truck with GigaSpace cab, side air deflectors and an add-on height of 765 mm

Winter operation

Winter driving

Before the journey

! At very low outside temperatures, make sure that the engine oil added is of an appropriate SAE classification. Using engine oils that are not suitable for very low outside temperatures may result in engine damage.

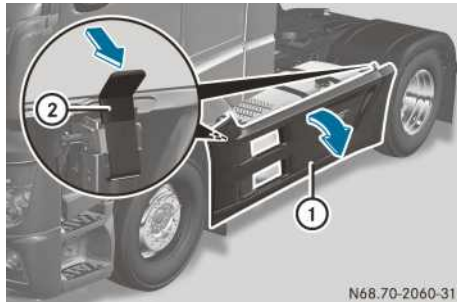

Side panelling with quick-release fastener (example: Actros semitrailer tractor vehicle)

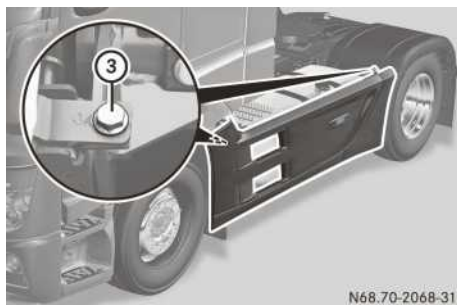

Side panelling with bolts (example: Actros semitrailer tractor vehicle)

Remove snow and accumulations of ice on both sides of the vehicle between the side panelling and the chassis frame.

▶ Completely depress front and rear levers ② on the quick-release fasteners.

or

▶ Unscrew front and rear bolts ③.

i Renew the lubricant on the quick-release fasteners from time to time. This ensures the quick-release fasteners work smoothly.

- ▶ Pull side panelling ① out of the holders on the clasp and swing them outwards.
- ▶ Remove snow and ice from between side panelling ① and the chassis frame.
- ▶ Swing side panelling ① back and press into the holders on the clasp.
- ▶ Pull front and rear levers ② up completely.
- or
- ▶ Tighten front and rear bolts ③.

Before the onset of winter, make sure that:

- the coolant contains sufficient antifreeze (▷ page 420)
- the fuel used is suitable for winter use (▷ page 422)
- the oil is changed in good time if single-grade engine oil is being used (▷ page 419)
- the windscreen washer system/headlamp cleaning system contains sufficient antifreeze (▷ page 357)
- suitable winter tyres are fitted

In wintry conditions, the law may require that winter tyres be fitted on the wheels of the drive axle. Find out which winter tyres are suitable for your needs. Observe the legal requirements for the country you are currently in.

- snow chains are carried in the vehicle

Jump-starting aids

! Warning

Fluid or gaseous ignition aids react immediately with fuel vapours and are highly flammable. There is a risk of explosion.

Do not use fluid or gaseous ignition aids to start the engine.

Notes on driving

! Vehicles without acceleration skid control (ASR): quick changes from slippery to high grip surfaces whilst the drive wheels are spinning can result in damage to the differential gear system. For this reason, avoid wheelspin of the drive wheels.

Please observe the following instructions on driving in winter:

- in snow, slush and on icy roads, fit snow chains to the drive wheels in good time
- adapt your driving style to the wintry road conditions
- if traction problems occur when driving with snow chains, deactivate ASR (▷ page 266) or the Stability Control Assist (▷ page 267)

Snow chains

Notes on snow chains

WARNING

If you drive too fast with snow chains fitted, they may snap. As a result, you could injure others and damage the vehicle. There is a risk of an accident.

Observe the maximum permissible speed for operation with snow chains.

! Only use snow chains that have been approved and recommended for Mercedes-Benz. This will prevent you from causing damage to the vehicle. If you have questions, consult a qualified specialist workshop.

! Mercedes-Benz recommends that you fit snow chains to all drive wheels. If your vehicle has permanent all-wheel drive and you do not fit snow chains to all drive wheels, activate the inter-axle lock. You could otherwise damage the differential.

The law may require that snow chains be removed as soon as possible once the road is clear of snow. The vehicle's driving and braking characteristics will be adversely affected if you drive on roads that are clear of snow with snow chains fitted to the vehicle.

Observe the notes of the snow chain manufacturer on the maximum permissible speed for operation with snow chains.

When using the snow chains described here, observe the legal requirements for the country you are currently in.

Do not use twin chains on vehicles with roll control. Only fit snow chains on the exterior wheels.

Vehicles with electric power steering: if you change the mechanical axle stops, e.g. when using snow chains, have the electric power

steering taught-in at a qualified specialist workshop.

- ▶ Vehicles with ASR/stability control assistant: if traction problems occur when driving with snow chains, deactivate ASR (▷ page 266) or Stability Control Assist (▷ page 267).

Checking the wheel clearance

! If the clearance between the snow chain and steering linkage is less than 25 mm, the snow chain could damage the steering linkage. In this case, remove the snow chains again. Have the steering geometry checked at a qualified specialist workshop.

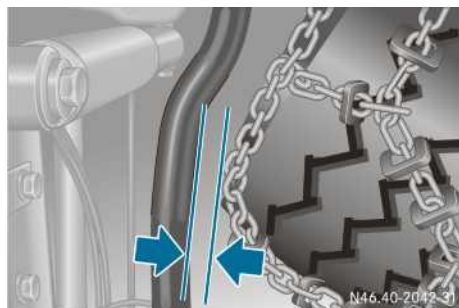

Example: drag link

- ▶ Apply the parking brake.
- ▶ Fit snow chains in accordance with the fitting instructions of the chain manufacturer.
- ▶ Start the engine.
- ▶ Turn the steering wheel towards the co-driver's side to the stop. With the steering on full lock, there must be a clearance of at least 30 mm between the snow chain and the drag link.

Cold climate package

Cold-start limits

Without optional equipment, your vehicle is capable of starting at temperatures as low as -20°C . When fitted with the optional equipment and filled with cold-resistant service products, your vehicle can be started at temperatures as low as -30°C .

i At temperatures lower than the stated cold-start limits, engine starting may be impaired despite taking the appropriate measures.

Optional equipment

The following optional equipment improves the starting capability of your vehicle at low outside temperatures:

- fuel preheating system
- coolant preheater
- heated electronic air processing unit
- auxiliary heating

Cold-resistant service products

Assembly	Service product (Sheet No.) ³
Fuel system	Winter diesel fuel down to -22 °C
Engine	Engine oil (228.51) SAE 5W 30 A 000 989 69 01
Transmission, transfer case	Transmission oil (235.11) SAE 75W 90 A 001 989 28 03
All-wheel-drive front axle, rear axles, inter-axle	Hypoid gear oil (235.8) SAE 75W 90 A 001 989 27 03 or A 001 989 53 03
Steering	Hydraulic fluid (345.0) ⁴ A 001 989 24 03
Engine cooling system	Coolant (325.5) Mixing ratio 50% by volume Coolant/50% by volume water

Have the vehicle converted to cold-resistant service products at a qualified specialist workshop.

Remember to fill the vehicle fuel tank with winter diesel fuel when it is time to do so.

- i** If the vehicle is mainly operated at very low temperatures, the maintenance intervals are reduced.

Coolant preheater

The coolant preheater consists of an electrical heating element that is installed in the engine crankcase. The coolant preheater is operated at 230 V independently of the vehicle's electrical system.

- i** You can have the basic wiring for the coolant preheater retrofitted at a qualified specialist workshop.

Notes before attempting a cold start

! The fluid in discharged batteries may freeze at extremely cold temperatures. Do not rapidly charge cold batteries. Otherwise, you could damage the batteries.

Special measures must be taken before a cold start if the vehicle has been exposed to extremely low temperatures.

- ▶ Charge discharged batteries before starting.
- i** The capacity of the batteries is adversely affected by increasingly cold temperatures.
- ▶ Thaw frozen batteries before charging them.

Starting the engine

! If the ignition lock is switched to the drive position and you notice a low battery voltage or an event window shows the  symbol, do not start the engine. A starting attempt could damage the batteries if they are cold or not fully charged.

! The lubricity of the engine oil and transmission oil may be reduced at very low outside temperatures. Driving a cold vehicle may result in damage to the drivetrain and assemblies.

! If a warning tone sounds and the red event window with the  symbol appears in the on-board computer, the operating safety of the engine is jeopardised.

Do not pull away, or stop the vehicle as soon as possible, paying attention to road and traffic conditions. You could otherwise damage the engine.

³ Mercedes-Benz Specifications for Service Products.

⁴ The use of the hydraulic fluid is not permitted in vehicles with a steered leading/trailing axle. A list of approved service products can be found in the Mercedes-Benz Specifications for Service Products.

- ▶ Switch off all electrical consumers (e.g. radio, blower).
- ▶ At outside temperatures below $-20\text{ }^{\circ}\text{C}$ and on vehicles with an auxiliary heater (auxiliary heater for cab and engine, 9 kW): preheat the engine with the auxiliary heater before starting the engine (▷ page 125).
- ▶ At outside temperatures below $-30\text{ }^{\circ}\text{C}$ on vehicles with a coolant preheater: preheat the engine using the coolant preheater for at least 90 minutes.
- ▶ Switch the ignition lock to the drive position.
- ▶ Observe the outside temperature shown in the display (▷ page 130) and watch out for signs of low on-board voltage, e.g. the vehicle lights are weak.
- ▶ Shift into neutral.
- ▶ Disengage power take-off (▷ page 343).
- ▶ Start the engine.
In vehicles with automated manual transmissions, the clutch is opened automatically at temperatures of $-5\text{ }^{\circ}\text{C}$ or below in order to make it easier to start the engine.
- ▶ Release the Start/Stop button once the engine has started.
The idling speed is controlled automatically.

If the engine does not start:

- i** The starting procedure is automatically cancelled:
 - after approximately 60 seconds on vehicles with the OM 936 engine
 - after approximately 40 seconds on vehicles with the OM 470, OM 471 or OM 473 engine
- ▶ Switch the ignition lock to position **0**.
- ▶ Repeat the starting procedure after approximately 1 minute.
- ▶ After three starting attempts, wait approximately 3 minutes before trying again.
- ▶ If the reservoir pressure in the brake system (▷ page 148) has fallen below 6 bar, charge the compressed-air system (▷ page 394).
This ensures that the clutch opens when starting the engine in vehicles with automated manual transmission.

Driving in extremely cold conditions

Observe the following at outside temperatures below $-20\text{ }^{\circ}\text{C}$:

- Before pulling away, check the reservoir pressure in the brake system (▷ page 148).
Do not pull away until there is sufficient reservoir pressure.
- Before pulling away, check that the steering is sufficiently warm. Only then is the operating efficiency of the steering ensured.
Hydraulic steering operation may be restricted at outside temperatures below $-25\text{ }^{\circ}\text{C}$.
- Shift gear early and avoid high engine speeds.
- Avoid putting the engine under excessive load when pulling away.
- Avoid running the engine for brief periods.
- Warm the vehicle up for around 20 minutes before increasing the load.
- For technical reasons, the engine brake is only available from an oil temperature of $15\text{ }^{\circ}\text{C}$ at level 1.
The full engine braking effect is only available across the entire engine speed range from an oil temperature of $60\text{ }^{\circ}\text{C}$.
- The battery can only be charged at a certain rate per hour, regardless of the power output of the alternator. The rate of charge is significantly reduced by low outside temperatures. As a result, the battery may take much longer to charge in winter.

Parking in extremely cold conditions

If the vehicle is parked at outside temperatures of below $-30\text{ }^{\circ}\text{C}$, it cannot be guaranteed that the engine will start, even with the cold climate package. Mercedes-Benz advises against parking the vehicle outdoors at outside temperatures of below $-30\text{ }^{\circ}\text{C}$.

Observe the following if the vehicle has to be parked outdoors at extremely low temperatures:

- ▶ If necessary, ensure adequate vehicle lighting by using external lighting, e.g. warning lamps.
- ▶ Check the fuel level on the fuel gauge (▷ page 129).
- ▶ If the fuel level is down to the reserve level, fill up the fuel tank (▷ page 315).
- i** You may have to bleed the fuel system if the fuel level is too low for longer periods (▷ page 376).

Observe the additional instructions and information on batteries (> page 366).

Useful information

These Operating Instructions describe all the models and standard and optional equipment of your vehicle that were available at the time of going to print. Country-specific differences are possible. Bear in mind that your vehicle may not be equipped with all the functions described. This also applies to safety-relevant systems and functions.

Read the information on qualified specialist workshops (▷ page 31).

Power take-offs

Function and notes

WARNING

When using the engine run-on function, the vehicle may start to roll if crawler mode is activated and the pulling-away gear is engaged. There is a risk of an accident.

When using the engine run-on function:

- shift the transmission into neutral.
- apply the parking brake.

Vehicles with a clutch pedal:

After declutching, you must wait for 10 seconds before engaging or disengaging the power take-off. In this way you will avoid consequential damage.

You can use power take-off to drive auxiliary equipment, e.g. hydraulic pumps. The engine and power take-off must be operated at a certain engine speed (working speed), depending on the conditions of use.

The working speed can be changed:

- via the on-board computer in the driving systems menu, **Engine speed** window (▷ page 345)
- using the  constant engine speed switch (▷ page 345)

Power take-offs with speed limiter: when power take-off is engaged, the set working speed cannot be exceeded.

The display of the on-board computer shows the activation state of power take-off:

 Power take-off disengaged

 Power take-off engaged

Vehicles with a power take-off on the engine:

power take-off on the engine is not selectable. The auxiliary equipment is connected directly to the engine and is continuously in operation. The working speed and body-dependent functions are controlled and activated when constant engine speed  (▷ page 345) is switched on.

Vehicles with transmission-driven power take-off:

if power take-off is engaged, you can select any pulling-away gear or reverse gear when stationary. Changes of direction are only permissible in the selected gear. You may not change gear while driving. On vehicles with an automated manual transmission, the transmission changes automatically to manual drive program **M** when power take-off is switched on.

Vehicles with transmission-independent power take-off (NMV), without clutch actuator (N4Y or N4Z):

pulling away is not possible when power take-off is engaged. You cannot operate power take-off while the vehicle is in motion.

Vehicles with transmission-independent power take-off (NMV), without clutch actuator (N4X or N4W):

if power take-off is engaged, you can select any pulling-away gear or reverse gear when stationary. During the journey you can select any gear.

If you have to leave the cab to operate power take-off, you can use the ignition lock's engine run-on function (▷ page 239). The engine continues to run and the doors of the cab can be locked with the key.

When power take-off is engaged, manual regeneration is interrupted. Manual regeneration cannot be started if power take-off is active.

 The engine speed may rise and the engine noise may change while regeneration is in process.

 If you have to leave the cab to operate power take-off, observe the important safety notes on the diesel particle filter (▷ page 311).

Preselecting the working speed

General notes

On vehicles with a transmission-driven power take-off it is possible to preselect the working speed.

Vehicles with Mercedes PowerShift

You can preselect the working speed using the multifunction lever.

- ▶ Turn the direction switch to position **N**. Depending on the previously selected splitter group, either **N1** or **N2** is shown in the display.
- ▶ **To preselect a high working speed:** pull the multifunction lever up briefly. The high-speed splitter group is selected and **N2** is shown in the display.
- ▶ **To preselect a low working speed:** push the multifunction lever down briefly. The low-speed splitter group is selected and **N1** is shown in the display.

Vehicles with manual transmission

You can preselect the working speed using the splitter switch.



- ▶ **To preselect a high working speed:** pull the splitter switch up. The high-speed splitter group is selected.
- ▶ **To preselect a low working speed:** push the splitter switch down. The low-speed splitter group is selected.

Engaging power take-off

General notes



Example: power take-off switch (power take-off 1)

-  transmission-driven power take-off 1
-  transmission-driven power take-off 2
-  transmission-driven power take-off 3 (NMV)



The power take-off on the engine is not selectable. The working speed and body-dependent functions are controlled and activated when constant engine speed  (> page 345) is switched on.



Transmission-driven power take-off (NMV)  may only be engaged three times per minute. Power take-off must be load-free when engaging/disengaging. Also observe the body/equipment mounting directive.

If you want to use a transmission-driven power take-off and a transmission-independent power take-off (NMV) simultaneously, observe the correct sequence when engaging/disengaging. First engage the transmission-driven power take-off, then the transmission-independent power take-off (NMV). When disengaging, first disengage the transmission-independent power take-off (NMV), then the transmission-driven power take-off. Make sure the required power take-off output does not exceed the maximum engine power for the given operating point.

Engaging power take-off

- ▶ Stop the vehicle.
- ▶ Apply the parking brake.
- ▶ Shift into neutral.
- ▶ Leave the engine running at idling speed.
- ▶ Vehicles with manual transmission: depress and hold down the clutch pedal.

- ▶ Press the upper section of switch  of the power take-off.
If power take-off is engaged, the  activation status indicator is shown in the display of the on-board computer. The indicator lamp in the  switch of the power take then lights up.
- ▶ Vehicles with manual transmission: when the display shows the engaged power take-off, release the clutch pedal.

i The indicator lamp in the  switch of the power take-off flashes for approximately 1.5 seconds. Only then is power take-off engaged. If you press the lower section of the  switch of the power take-off during this period, power take-off will not be engaged.



You cannot engage power take-off when the parking brake is released. In this case, the yellow event window in the on-board computer shows  and **Engage parking brake**. Apply the parking brake and engage power take-off again.

If the  symbol flashes in the display of the on-board computer, the electronic management system does not recognise the vehicle's current operating state:

- ▶ Check the vehicle's operating state:
 - the transmission is in neutral
 - vehicles with manual transmission: the clutch pedal is depressed
 - the vehicle is stationary
 - the parking brake is applied
- ▶ Engage power take-off again.
- ▶ If the  symbol flashes in the display of the on-board computer again, visit a qualified specialist workshop.
- i** Automatic regeneration causes high engine speeds in the transmission-driven power take-off. Operating power take-off is only permitted during automatic regeneration if power take-off operation is designed for performance at high engine speeds in regeneration mode. The programmable special module (PSM) does not permit a gear to be engaged. Wait for automatic regeneration and activate the transmission-driven power take-off again.

Disengaging power take-off

- ▶ Leave the engine running at idling speed.
- ▶ Vehicles with manual transmission: depress and hold down the clutch pedal.

- ▶ Press the lower section of the  switch of the power take-off.
When power take-off is disengaged,  appears in the display of the on-board computer and the indicator lamp goes out in the  switch of the power take-off.
- ▶ Vehicles with manual transmission: when the display no longer shows power take-off, release the clutch pedal.

Emergency mode of the transmission-independent power take-off (NMV)

WARNING

With the engine running, the output shaft for the engine-bound power take-off may turn. There is a risk of injury.

Only operate the emergency gearshift for the engine-driven power take-off when the vehicle is stationary, the parking brake applied and the engine switched off.

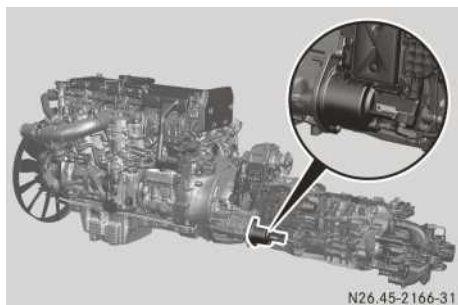
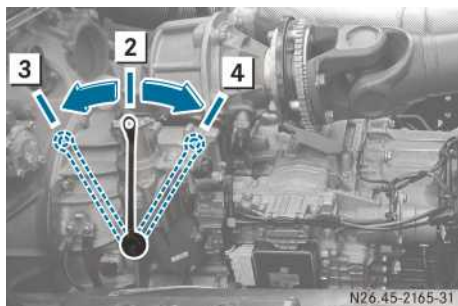
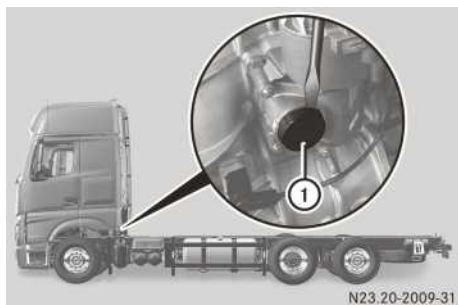





Clutch actuator in vehicles with power take-off N4W or N4X

If the transmission-independent power take-off fails, you can establish or release a rigid connection of the power transmission in power take-off. When disengaging manually, make sure power take-off is not under load. Switch pumps to zero delivery, for example.

You can recognise vehicles with power take-off N4W or N4X by the external clutch actuator. If there is a cover plate in this position then the vehicle is equipped with power take-off N4Y or N4Z.



- ▶ **To engage power take-off manually:** apply the parking brake.
- ▶ Shift into neutral.

- ▶ Switch off the ignition.
- ▶ Take the adapter, wrench, screwdriver and hammer out of the vehicle tool kit.
- ▶ Remove covering cap ① with a screwdriver and a hammer.
- ▶ Place the adapter and wrench at position ② on the shaft.
- ▶ Turn the wrench to position ④.
- ▶ Remove the wrench and adapter.
- ▶ Attach covering cap ①.
- ▶ Start the engine.
- ▶ Press the upper section of the  power take-off switch. If power take-off is engaged, the  activation status indicator is shown in the display of the on-board computer. The indicator lamp in the  switch lights up.
- ▶ **To disengage power take-off manually:** start the engine.
- ▶ Shift into neutral.
- ▶ Press the lower section of the  switch.
- ▶ Apply the parking brake.
- ▶ Switch off the ignition.
- ▶ Take the adapter, wrench, screwdriver and hammer out of the vehicle tool kit.
- ▶ Remove covering cap ① with a screwdriver and a hammer.
- ▶ Place the adapter and wrench at position ② on the shaft.
- ▶ Vehicles with power take-off N4Y or N4Z: turn the wrench to position ③.

or

- ▶ If power take-off is automatically engaged in advance by the switch in vehicles with power take-off N4W or N4X: turn the wrench to position ④.

or

- ▶ If power take-off is manually engaged in advance in vehicles with power take-off N4W or N4X: turn the wrench to position ③.
- ▶ Remove the wrench and adapter.
- ▶ Attach covering cap ①.
- ▶ Start the engine. If power take-off is disengaged,  appears in the display of the on-board computer and the indicator lamp in the  switch goes out.

Engine speed setting







You can set the idling speed and the working speed.



To operate auxiliary equipment, e.g. hydraulic pumps, the engine must be running at a specific speed (working speed).

- ▶ Stop the vehicle.
- ▶ Apply the parking brake.
- ▶ Shift into neutral.
- ▶ Engage power take-off.

Activating the engine speed setting and setting the engine speed

- ▶ Press the  button on the multifunction steering wheel repeatedly until the **Engine speed** input window is shown in the on-board computer.
- ▶ Press the  or  button to increase or decrease the engine speed in increments of approximately 20 rpm.
- ▶ Press the  button to exit the input window. or
- ▶ Wait for approximately 3 seconds.
The setting is stored automatically.

Deactivating the engine-speed setting

- ▶ Press the  button repeatedly until the on-board computer shows the **Engine speed** input window.
- ▶ Press the  button.

The engine speed setting is automatically reset if you drive faster than approximately 20 km/h.





Constant engine speed



When the constant engine speed function is activated, the set working speed for power take-off is controlled by the electronic management system, regardless of the load.

i The constant engine speed function is used to set the working speed governor. In working speed operation, regeneration is suppressed. Deactivate the constant engine speed function after operating power take-off. Otherwise, regeneration cannot take place.

As well as the constant engine speed other structurally dependent functions can be activated in vehicles with power take-off on the engine.

- ▶ Stop the vehicle.
- ▶ Apply the parking brake.
- ▶ Shift into neutral.
- ▶ Engage transmission-driven or transmission-independent power take-off.
- ▶ **To activate:** press the upper section of the  switch. The indicator lamp in the  switch lights up.
- ▶ **To deactivate:** press the lower section of the  switch. The indicator lamp in the  switch goes out.

Tipper operation

Before tipping

WARNING

The rear exterior lighting is concealed when the tailgate is opened. This could cause other

road users to fail to recognise the vehicle in time. There is a risk of an accident.

Make sure that the vehicle is safeguarded at the rear in accordance with national legal requirements, e.g. with a warning triangle.

! When picking up or setting down a container, the wheels on the front axle must not be allowed to lift clear of the ground. Otherwise, the chassis frame can be damaged.

Run the engine when coupling to a semitrailer or picking up demountable bodies or containers.

! Observe the maximum gross axle weight when tipping, rolling away or setting down demountable bodies or containers. Do not exceed the values given in the body/equipment mounting directive.

The following parts of the vehicle may otherwise be damaged:

- tyres
- chassis
- axles

You will need to complete the connection between the auxiliary subframe and the vehicle chassis in the crane area. This can either be done with a crane mounting or another adequate mounting. Observe the body/equipment mounting directive. Tipper operation is not permitted if you do not complete the connection.

Be sure to follow the safety regulations and the tipper manufacturer's separate operating instructions.

When the tipper pump (power take-off) is engaged, you can select any pulling-away gear or reverse gear when stationary. Changes of direction are only permissible in the selected gear. You may not change gear while driving. On vehicles with an automated manual transmission, the transmission changes automatically when the tipper pump is switched to manual drive program **M**.

Unless otherwise stated in the tipper manufacturer's operating instructions, be sure that the low-speed splitter group is always selected.

- ▶ Park the vehicle on a firm and level surface.
- ▶ Apply the parking brake.

- ▶ Check and secure the pins on the tipper body; see the manufacturer's separate operating instructions.

The tipper body must always be secured with pins on a side to which the load is to be tipped. The pins have different shapes to prevent confusion or diagonal insertion.

- ▶ Start the engine.
- ▶ Switch on the tipper pump (power take-off) (▷ page 341).
The chassis frame is lowered automatically. The display shows the  symbol for chassis frames below driving level.
- ▶ Open the dropside and ensure that the dropside unlocks and opens in the case of automatic release/locking mechanisms. See the tipper manufacturer's separate operating instructions.

Tipping

- ▶ Make sure that nobody is in the tipping area.
- ▶ Observe the operating instructions issued by the tipper manufacturer.

After tipping

- ▶ Close the dropside and ensure that the dropside closes and locks in the case of automatic release/locking mechanisms. See the manufacturer's separate operating instructions.
- ▶ Switch off the tipper pump (power take-off) (▷ page 341).
- ▶ Raise the chassis frame to driving level (▷ page 295).
The  symbol for chassis frames below driving level goes out in the display.

Controls

General notes

To activate the tipper body and other functions, controls for pneumatic pick-up and actuating valves can be fitted on the door side next to the driver's seat. The door trim is then adjusted for adequate space. The control knob and pull switch can also be fitted in multiple ways and in different combinations, depending on the function.

The following functions are examples and are displayed on a sticker next to the controls in the driver's entrance/exit. For the actual function, observe the tipper or body manufacturer's operating instructions.

Pick-up valve for tipper control

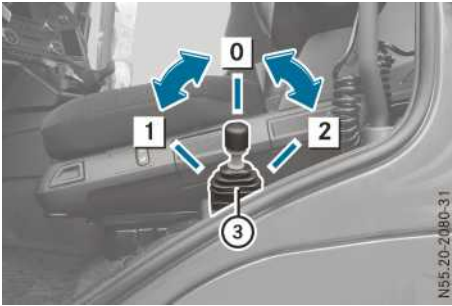

- 1 To lower tipper body
- 0 STOP – stops the tipping or lowering movement
- 2 To raise tipper body
- 3 Control lever with pull ring

Control lever 3 engages in position 2. To move the control lever in or out of position 2 you have to pull the pull ring on the control lever.

Actuating valves for switching or activating

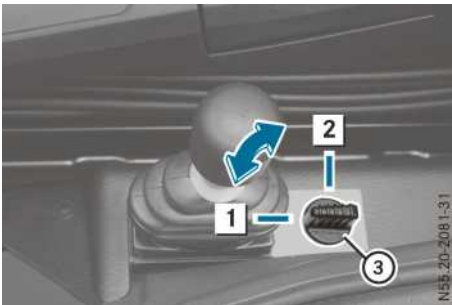

Control knob

Switching trailer operation

- 1 Activate tipper body on towing vehicle
- 2 Activate tipper body on trailer

Switching crane operation

- 1 Tipper function
- 2 Crane function

Activating rear wall claw-type lock

- 1 Unlock claw-type locks
- 2 Lock claw-type locks
- 3 Control knob

Actuating valve for on-board computer

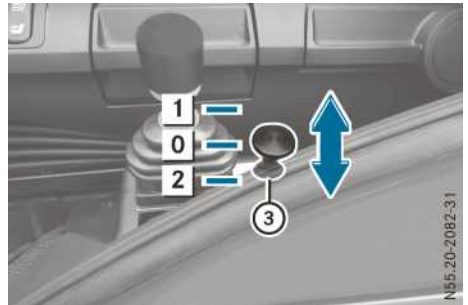

Pull switch

- 1 Open dropside
- 0 STOP – stop movement
- 2 Close dropside
- 3 Pull switch

Useful information

These Operating Instructions describe all the models and standard and optional equipment of your vehicle that were available at the time of going to print. Country-specific differences are possible. Bear in mind that your vehicle may not be equipped with all the functions described. This also applies to safety-relevant systems and functions.

Read the information on qualified specialist workshops (▷ page 31).

Cleaning and care

Notes on care

Environmental note

Only wash your vehicle at a wash bay designed for this purpose. Dispose of empty containers and used cleaning products in an environmentally responsible manner.

Regular care helps to maintain the value of the vehicle.

Mercedes-Benz recommends that you only use care products that have been approved for Mercedes-Benz. You can obtain these care products from any Mercedes-Benz Service Centre.

If you need to wash upper parts of the vehicle, always use a suitable ladder or another non-slip climbing aid.

Cleaning the interior

Cleaning with a high-pressure cleaner

- !** Observe the following points when wet cleaning the vehicle interior:
 - Never use a high-pressure cleaner.
 - Make sure that no liquids enter or are left in gaps or cavities.
 - Ensure that there is sufficient ventilation when cleaning.
 - Make sure that the vehicle interior dries completely after cleaning.

Cleaning the plastic trim

WARNING

Care products and cleaning agents containing solvents can cause surfaces in the cockpit to become porous. This could result in plastic parts breaking away when the airbags are deployed. There is a danger of injury.

Do not use care products and cleaning agents containing solvents to clean the cockpit.

- !** Do not affix the following to plastic surfaces:
 - stickers
 - films
 - scented oil bottles or similar items
 You could otherwise damage the plastic.
- !** Do not allow cosmetics, insect repellent or sunscreen to come in contact with the plastic trim. This maintains the high-quality look of the surfaces.
 - ▶ Wipe the plastic trim and dashboard with a damp, lint-free cloth, e.g. a microfibre cloth.
 - ▶ **Heavy soiling:** use a mild washing solution or care and cleaning products recommended and approved by Mercedes-Benz.

Cleaning the trim elements

- !** Do not use solvent-based cleaning agents such as tar remover, wheel cleaners, polishes or waxes. There is otherwise a risk of damaging the surface.
 - ▶ Clean the trim elements with a damp, lint-free cloth, e.g. a microfibre cloth.
 - ▶ **Heavy soiling:** use care and cleaning products recommended and approved by Mercedes-Benz.

Cleaning the steering wheel and gear lever

- !** Avoid fluids coming into contact with the steering wheel or the steering-wheel buttons, especially if they contain sticky substances. Operation of the steering-wheel buttons may otherwise be affected, e.g. separate buttons becoming stuck together.

- ▶ Thoroughly wipe with a damp cloth.
- ▶ **Vehicles with leather upholstery:** use leather care agents recommended and approved by Mercedes-Benz after cleaning.

Cleaning the seat covers

! Microfibre cloths should not be used to clean covers made from genuine or artificial leather. The microfibre cloth can damage the cover if used frequently.

! Clean:

- artificial leather covers with a cloth moistened with a solution containing 1% detergent, e.g. washing-up liquid.
- cloth covers with a microfibre cloth moistened with a solution containing 1% detergent, e.g. washing-up liquid. Wipe entire seat sections carefully to avoid leaving visible lines. Leave the seat to dry afterwards. Cleaning results depend on the type of dirt and how long it has been there.
- genuine leather covers carefully with a damp cloth, then wipe the covers down with a dry cloth. Make sure that the leather does not become soaked. Otherwise, the leather could become rough or cracked. Only use leather care agents that have been tested and approved by Mercedes-Benz. You can obtain these from a qualified specialist workshop.

Please note that:

- leather covers are a natural product and are therefore subject to a natural ageing process. Leather can respond differently to certain environmental influences (e.g. high humidity or severe heat); for example, more strongly defined folds can develop.
- regular care is required if the look of the leather covers and their touch and feel are to be preserved in the long term.

Cleaning the seat belts

! Observe the following notes on cleaning the seat belts:

- remove any stains or dirt immediately. This will avoid residue or damage.
- do not bleach or dye the seat belts. This could impair the function of the seat belts.
- do not dry the seat belts in direct sunlight or at temperatures above 80 °C.

Clean the seat belts with a mild washing solution.

Cleaning the mattress cover

The removable mattress cover of the 7-zone cold foam mattress can be washed at max. 30 °C.

Cleaning the vehicle exterior

Notes on cleaning the vehicle exterior

WARNING

If the windscreen wipers are set in motion when cleaning the windscreen or wiper blades, you could become trapped. There is a danger of injury.

Always switch off the windscreen wipers and the ignition before cleaning the windscreen or wiper blades.

WARNING

If you use openings in the bodywork or detachable parts as steps, you could:

- slip and/or fall
- damage the vehicle and cause yourself to fall.

There is a danger of injury.

Always use secure climbing aids, e.g. a suitable ladder.

! Do not use parts of the vehicle or openings in the bodywork, such as battery compartment covers or fuel/AdBlue® tanks, as steps. Parts of the vehicle or openings in the bodywork can otherwise be damaged.

❗ Only direct the compressed-air, steam or water jet towards the radiator surface in a vertical direction. Ensure that the radiator fins are not damaged. Remove any dirt from the radiator fins. Damaged or dirty radiator fins can cause the engine to overheat. If there is a loss of coolant or damage to the cooling and heating system, have it checked at a qualified specialist workshop.

❗ In order to avoid consequential damage, repair damage caused by loose chippings and remove any dirt immediately, in particular:

- insect remains
- bird droppings
- flash rust
- tree resin
- oils and grease
- fuels
- tar stains
- salt residue

Wash your vehicle more frequently if it gets dirty more often.

❗ If the vehicle has Mercedes-Benz protective chassis sealing:

- do not use high-pressure cleaners or pulsating circular-jet nozzles.
- only clean with a water pressure up to a maximum of 3 bar.
- clean the vehicle with a water temperature up to a maximum of 40 °C.
- keep a distance of at least 30 cm between the nozzle and the vehicle.
- only use neutral cleaning agents in the mixing ratio prescribed by the manufacturer and do not use alkaline or acidic products.
- do not use any petrol-based substances, rape seed oil, diesel, petrol or other solvents.
- whenever the vehicle is used, remove corrosive substances with water afterward.
- before and after each use during winter, check the anti-corrosion protection, and touch it up if necessary.

When cleaning the vehicle, always use the vehicle's steps and grab handles or secure climbing aids, such as a suitable ladder.

Scratches, corrosive deposits, corrosion and damage caused by neglect or incorrect care

cannot always be completely rectified. In such cases, contact a qualified specialist workshop.

Steps

Important safety notes

⚠ WARNING

If the step is folded out but not locked, it may swing to the side when you climb up or down. This could cause you to slip and/or fall from the step. There is a risk of injury.

Always lock the folding step before stepping onto it.

Keep steps and grab handles free from dirt, such as:

- mud
- clay
- snow
- ice

This increases the safety of your footing.

Steps, front

❗ Ensure that you do not step too low when using the lowest access steps. Otherwise, you could damage the protective grid or the air regulation system.



N68.70-2054-31

Example: Actros L cab, steps and grab handles

► Tilt folding steps ③ forwards.

Use steps ④, ③ and grab handle ① when cleaning the vehicle. To have better and safer

access to grab handles ①, use recesses ② when ascending.

Small folding step, front

! If you drive the vehicle with the step folded down, the step can come into contact with the road surface and be damaged, e.g. when driving off-road.

Therefore, fold up the step before driving off. Do not drive with the step folded down.

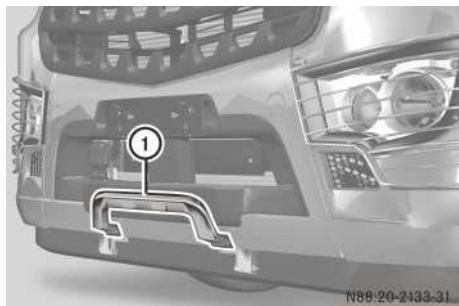

Example: small folding step, front

- ▶ **To fold down:** swing step ① down to the stop.
- ▶ **To fold up:** swing step ① upwards until it engages.

Large folding step, front

! If you drive the vehicle with the step folded down, the step can come into contact with the road surface and be damaged, e.g. when driving off-road.

Therefore, fold up the step before driving off. Do not drive with the step folded down.

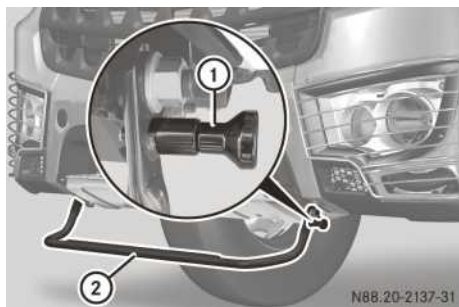

Example: large folding step, front

▶ **To fold down:** push step ② up a little, pull out retainer ① and swing step ② down to the stop.

▶ **To fold up:** pull retainer ① and swing step ② upwards until it engages.

▶ Make sure that retainer ① has engaged on both sides.

Side steps

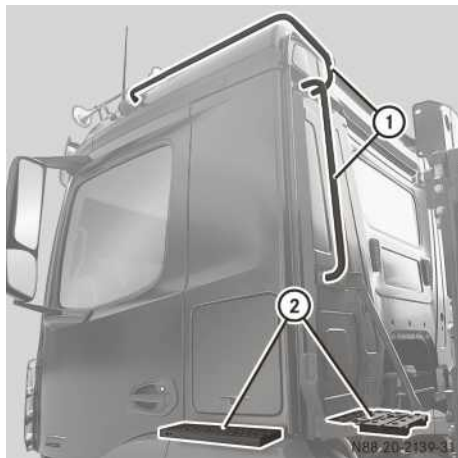

Step and grab handle tipper vehicle (example)

- ① Grab handle
- ② Steps

Steps for semitrailer tractor vehicles

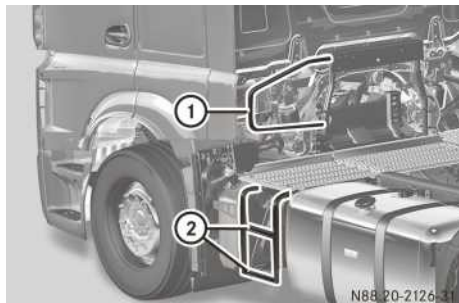

Steps and grab handle (example: Actros tractor/ semitrailer combination without side trim panel)

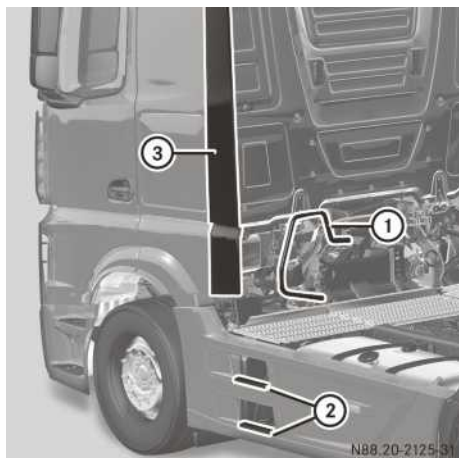

Steps and grab handle (example: Actros tractor/ semitrailer combination with side trim panel)

► Vehicles with side air deflector: fold side air deflector ③ inwards.

Use steps ② and grab handle ① when cleaning the vehicle.

Cleaning the exterior lighting

❗ Only use cleaning agents or cleaning cloths that are suitable for plastic lenses. Unsuitable cleaning agents or cleaning cloths could scratch or damage the plastic lenses of the exterior lighting.

► Clean the plastic covers of the exterior lighting with a wet sponge and a mild cleaning agent, e.g. Mercedes-Benz car shampoo or cleaning cloths.

Cleaning the distance sensor



Distance sensor (example: Actros)

Clean the cover of distance sensor ① regularly. In this way, you will avoid malfunctions.

If the distance sensor is dirty, the on-board computer shows the  **Distance sensor dirty** message in the yellow event window.

Rain/light sensor and Lane Keeping Assist and ATTENTION ASSIST camera



Regularly clean the windscreen in the area of rain/light sensor ② and camera ①. In this way, you will avoid malfunctions.

If the area of the windscreen used by rain/light sensor ② and camera ① is damaged:

- the function of Lane Keeping Assist/ATTENTION ASSIST and of rain/light sensor ② could be restricted
- have the windscreen replaced at a qualified specialist workshop

Cleaning the Sideguard Assist sensors

- ❗ If you clean the sensors with a high-pressure cleaner, make sure that you keep a distance of at least 30 cm between the vehicle and the high-pressure cleaner nozzle. Information about the correct distance is available from the equipment manufacturer.

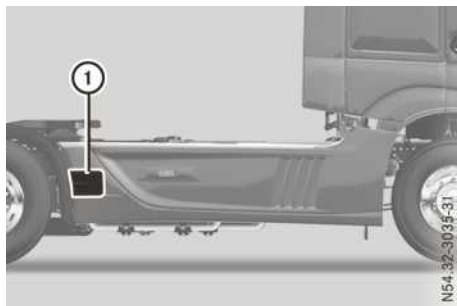

① Sideguard Assist sensors

Regularly clean the sensor cover ①. In this way, you will avoid malfunctions.

- ▶ Clean Sideguard Assist sensors ① with water, shampoo and a soft towel regularly.

High-pressure cleaning

⚠ WARNING

The water jet of circular-jet nozzles (dirt grinders) can cause damage not visible from the outside to tyres or chassis components. Components damaged in this way can unexpectedly fail. There is a risk of an accident.

Do not use high-pressure cleaners with circular-jet nozzles to clean the vehicle. Have damaged tyres or chassis components replaced immediately.

- ❗ Never use a high-pressure cleaner in the vehicle interior. The pressurised water created by the high-pressure cleaner and the associated spray could cause considerable damage to the vehicle.
- ❗ The BlueTec® exhaust gas aftertreatment system may only be cleaned when it is cool. The sensors could otherwise be damaged. When cleaning, make sure not to point the water jet at the exhaust pipe. Otherwise, the exhaust gas aftertreatment may be damaged.

- ❗ When using a high-pressure cleaner, keep a minimum distance of approximately 30 cm between the high pressure nozzle and the vehicle parts. Do not use a high-pressure cleaner with a round jet nozzle. Parts of the vehicle or engine can otherwise be damaged.

- ❗ Keep the water jet moving constantly while cleaning. In this way, you will avoid causing damage.

Do not point the water jet at:

- door joints
- air bellows
- brake hoses
- wheel balance weights
- electrical components
- electrical connectors
- seals

- ❗ If your vehicle has Mercedes-Benz protective chassis sealing, do not use a high-pressure cleaner. You could otherwise damage the protective sealing.

- ❗ Avoid deformation of the radiator core fins. This ensures a constant cooling output.



Environmental note

Only wash your vehicle at a wash bay designed for this purpose. Dispose of empty containers and used cleaning products in an environmentally responsible manner.

Automatic car wash

- ❗ Before washing the vehicle in an automatic car wash, fold in the exterior mirrors and switch off the windscreen wipers. Otherwise, the exterior mirrors and windscreen wipers could be damaged.

Make sure that the exterior mirrors are fully folded out again when you leave the automatic car wash.

If the vehicle is very dirty, pre-wash it before you put it through the automatic car wash.

After the automatic car wash, remove the wax from the windscreen and the wiper blades. This prevents smearing and reduces wiper noise, which occur as a result of residue on the windscreen.

Cleaning the engine

! Observe the following notes when cleaning the engine. This avoids malfunctions and damage to the engine.

- When using high-pressure or steam cleaners, do not point the spray directly at electrical components and electric cables.
- Make sure that no water enters the air intake and ventilation openings.
- Treat the engine with preservative agents after it has been cleaned. When doing so, protect the belt drive system from the preservative agent.
- Only use wax-based protective agents for engines that comply with Sheet No. 385.4 of the Mercedes-Benz Specifications for Service Products.

! When using high-pressure or steam cleaners, do not point the spray directly at radiator core fins, electrical components or electric cable ends.

In addition, observe the notes in the "High-pressure cleaning" section (▷ page 353).

Cleaning light-alloy wheels

! When cleaning the light-alloy wheels, do not use any acidic or alkaline cleaning agent. They may corrode the wheel nuts or the locking springs of the wheel balance weight.

! Do not point the water jet of high pressure or steam cleaners directly at the balance weights of the light-alloy wheel. They may become detached and lead to imbalance and increased tyre wear.

Clean the light-alloy wheels regularly.

In addition, observe the notes in the "High-pressure cleaning" section (▷ page 353).

Maintenance

Important safety notes

Environmental note

If circumstances require you to do some maintenance work yourself, you must observe the environmental protection requirements.

When disposing of service products, e.g.

engine oil, you must comply with the legal requirements. This also concerns all parts, e.g. filters, that have been in contact with service products.

Dispose of empty containers, cleaning cloths and care products in an environmentally responsible manner.

Observe the instructions for care products.

Do not let the engine run longer than necessary when stationary.

Like all technical equipment, the vehicle requires care and maintenance. The scope and frequency of maintenance work mainly depend on the operating conditions, which can differ widely.

You must secure the vehicle on axle stands of sufficient load-bearing capacity if work is being carried out underneath the vehicle. Never use the jack instead of stands. The jack could slip and the vehicle could drop. The jack is designed only to raise the vehicle for a short time, e.g. while a wheel is being changed.

When working on the vehicle, comply with all safety regulations, such as the operating instructions, regulations concerning hazardous materials, environmental protection measures, work safety and accident prevention regulations.

Inspection and maintenance work requires special skills that cannot be acquired by reading these Operating Instructions. Always have this work and maintenance work carried out by a qualified specialist workshop.

MS (maintenance system)

Introduction

The maintenance system calculates maintenance due dates for the vehicle and its assemblies based on the vehicle's operating conditions.

You can call up the maintenance due dates calculated for the vehicle and its assemblies in the on-board computer (▷ page 147).

The on-board computer first displays the maintenance due date in the event window 14 days before the respective maintenance date.

-  A qualified specialist workshop can program the first message to appear between 0 to 30 days before the due date.

When the maintenance due date has been reached or exceeded, the on-board computer shows additional event windows.

Automatic maintenance due date event window

WARNING

If you do not have the prescribed service/maintenance work or necessary repairs carried out, this could result in malfunctions or system failures. There is a risk of an accident. Always have the prescribed service/maintenance work as well as necessary repairs carried out at a qualified specialist workshop.

-  Not observing a maintenance due date event window and not having maintenance work performed on time can lead to damage to the vehicle or its assemblies. It could also result in increased wear. Always have maintenance work carried out on time and at a qualified specialist workshop.

If you set the ignition lock to the driving position and a maintenance date is due or has been exceeded, the on-board computer shows the dates in the grey event window (▷ page 157). When the maintenance due date has been exceeded, the on-board computer shows the overdue maintenance in the yellow event window (▷ page 161).

The maintenance system automatically notifies you of maintenance due dates, for example.:

-  **Air filter, 12.08.2014, 3000 km**
Maintenance due dates are displayed 14 days before the respective inspection is due.
-  **Air filter, Maintenance due**
The maintenance is due.
-  **Air filter, Maintenance due immediately**
The maintenance due date has been exceeded.

- To confirm the event window:** press the  button on the multifunction steering wheel.

Air filter

-  Do not clean the filter elements of the engine air cleaner. Knocking, blowing out or washing the filter medium could cause structural changes and damage. The necessary filtration grade of the filter element is then no longer guaranteed. This results in increased wear and tear and a reduced service life for the engine. Replace the air filter elements. Otherwise, you will lose your warranty entitlements and you can damage them then engine.

Maintenance flap

The fans for the condenser are under the maintenance flap on vehicles with electric auxiliary air conditioning.

WARNING

The fans on the condenser run when the auxiliary air conditioning is in operation. They may also continue to operate or suddenly start if the engine is running. There is a risk of injury.

If you have to open the maintenance flap:

- remove any jewellery and or watches
- never reach into the rotation area of the fans
- clothing and hair, for example, should kept clear of the fans

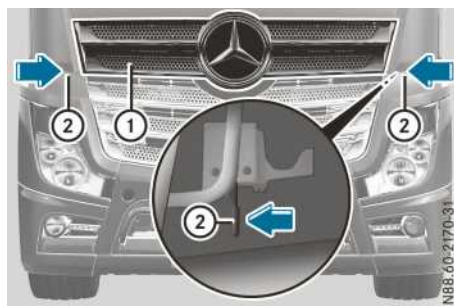

Maintenance flap (example: Actros)

The release levers are under the side panelling above the headlamps.

- ▶ **To unlock and open:** press release lever ② on the left and right, one after the other in the direction of the arrow.
- ▶ Swing maintenance flap ① up.
- ▶ **To close:** swing maintenance flap ① down until it audibly engages.

Maintenance points under the maintenance flap

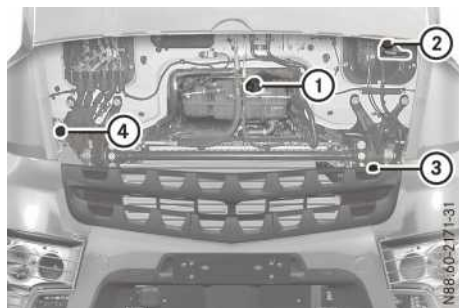

Example: maintenance points

- ① Coolant expansion tank with turquoise cap (▷ page 356)
- ② Hydraulic clutch actuation system with green cap (▷ page 357)
- ③ Engine oil filler neck with black cap (▷ page 360)
- ④ Washer fluid reservoir with black cap (▷ page 357)

Observe the instructions on the respective original container when using, storing and disposing of service products. Always store service products in the sealed original container. Always keep service products out of the reach of children.

- ⚠ Do not operate the vehicle if the coolant level is too low. Otherwise, the engine may be damaged.

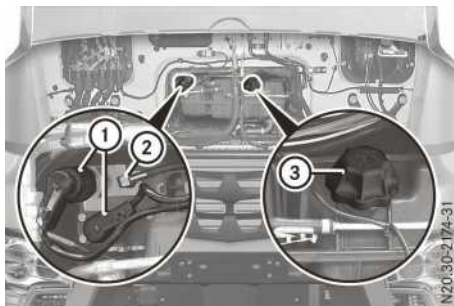

Example: coolant expansion tank

The coolant expansion tank may be under the maintenance flap or behind the cab.

Vehicles with retarders are equipped with a coolant pressure regulation system. The coolant pressure regulation system regulates and monitors the pressure in the engine cooling system. If the on-board computer shows the yellow **Coolant pressure regulation faulty** event window, check the electrical plug connectors of plugs ① and hose fitting ② for correct seating. Hose fitting ② and turquoise cap ③ must be free of leaks. If you detect any leakage, have the engine cooling system checked at a qualified specialist workshop.

If the coolant level in the coolant expansion tank is too low, the on-board computer displays the

Coolant level

⚠ WARNING

The cooling system is pressurised, particularly when the engine is warm. If you open the cap, you could be scalded if hot coolant sprays out. There is a risk of injury.

Let the engine cool down before you open the cap. Wear gloves and eye protection. Open the cap slowly to release the pressure.

⚠ WARNING

Service product can be poisonous and hazardous to health. There is a risk of injury.

yellow (▷ page 162) or red (▷ page 178) event window with the  symbol.

Only open the coolant expansion tank when the coolant temperature is below 50 °C.

The coolant level can only be accurately determined when the coolant temperature is between 0 °C and 25 °C. First check the coolant temperature using the on-board computer (▷ page 148).

If you need to top up coolant, add corrosion inhibitor/antifreeze additive as specified in Sheet No 325.5 to the water, e.g. Glysantin® G40®. Pay attention to the coolant mixture ratio and the water quality (▷ page 420). First, mix the water and the antifreeze/anti-corrosion additive together outside the coolant circuit, then fill the coolant expansion tank with the mixture.

- ▶ Park the vehicle on a level surface.
- ▶ Apply the parking brake.
- ▶ Switch off the engine.
- ▶ Vehicles with coolant expansion tank under the maintenance flap: open the maintenance flap (▷ page 355).
- ▶ Vehicles with coolant expansion tank behind the cab: slide cover ④ open.
- ❗ For vehicles with the coolant expansion tank behind the cab, ensure your footing is secure when refilling the coolant.
- ▶ Turn turquoise cap ③ slowly anti-clockwise and release the pressure.
- ▶ Unscrew and remove turquoise cap ③.
- ▶ Check coolant level.
The coolant in the expansion tank must reach up to the edge of the filler neck.
- ▶ Top coolant up to the edge of the filler neck.
- ▶ Replace turquoise cap ③ and tighten it as far as it will go.
- ▶ Vehicles with coolant expansion tank under the maintenance flap: close the maintenance flap.
- ▶ Vehicles with coolant expansion tank behind the cab: slide cover ④ closed.

Clutch actuation system

- ❗ Never top up with a brake fluid or hydraulic fluid of a different quality grade. You could otherwise damage the hydraulic clutch actuation system.

- ❗ The hydraulic system may be leaking if the fluid level in the expansion tank of the hydraulic clutch actuation system is below the minimum mark.

Have the hydraulic system checked at a qualified specialist workshop.

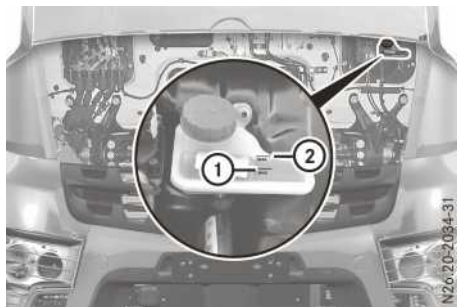

Example: clutch actuation system reservoir

The hydraulic fluid for the clutch actuation system must meet the specifications in Sheet No. 345.0 of the Mercedes-Benz Specifications for Service Products.

It is not necessary to renew the hydraulic fluid in the hydraulic clutch actuation system.

- ▶ Open the maintenance flap (▷ page 355).
- ▶ Check the fluid level in the expansion tank.
The fluid level must be between maximum mark ② and minimum mark ①.
- ▶ Close the maintenance flap.

Windscreen washer system/headlamp cleaning system

Topping up the washer fluid

WARNING

If windscreen washer concentrate comes into contact with hot components of the engine or the exhaust system, it can ignite. There is a risk of fire and injury.

Make sure the windscreen washer concentrate does not come into contact with the filler neck.

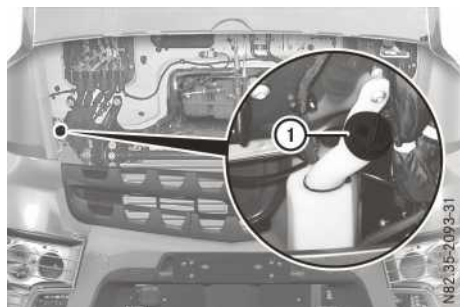

Example: washer fluid reservoir

Depending on the vehicle version, the washer fluid reservoir for the windscreen washer system and the headlamp cleaning system has a capacity of approximately 10 or 15 litres.

When the washer fluid level in the washer fluid reservoir is too low, the on-board computer displays a grey event window with the  symbol (▷ page 157).

Add a washer fluid concentrate according to Mercedes-Benz Specifications for Service Products Sheet No. 37 1.0 throughout the entire year. Adjust the mixing ratio to suit the outside temperature.

At temperatures above freezing, use a washer concentrate for the summer to prevent smearing. If there is a risk of frost, use a washer fluid concentrate for winter to prevent the water from freezing on the windscreen.

- ▶ Mix the washer fluid to the appropriate mixing ratio in a container beforehand.
- ▶ Open the maintenance flap (▷ page 355).
- ▶ Unscrew and remove cap ① of the washer fluid reservoir.
- ▶ Refill the washer fluid reservoir.
- ▶ Replace cap ① and screw it on.
- ▶ Close the maintenance flap.

Cyclone dust prefilter

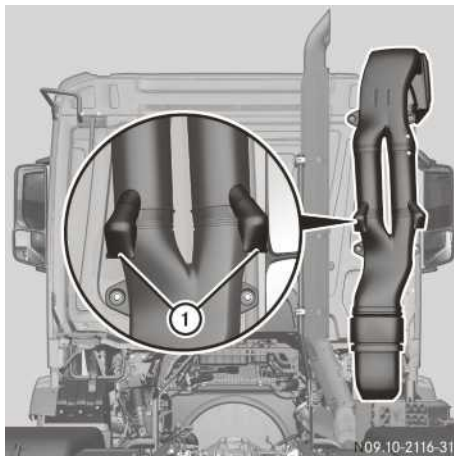

The cyclone dust prefilter is integrated into the inlet port and increases the operating life of the air filter in dusty conditions.

Dust particles escape from the inlet port on extraction valves ① to reduce clogging of the air filter. Dust particles can collect in extraction valves ① and for this reason extraction valves ① must be emptied regularly. If you regularly drive in dusty areas, empty the valve at least once per week and in the case of air with high concentrations of dust, once a day. Also check extraction valves ① regularly for damage. Have damaged extraction valves ① replaced immediately at a qualified specialist workshop.

- ▶ Stop the vehicle.
- ▶ Apply the parking brake.
- ▶ Switch off the engine.
- ▶ Hold the vessel under extraction valve ①.
- ▶ Press extraction valves ① together.

Coarse filter for heating and climate control

! The combination filter and pollen filter may not be cleaned. They must be replaced.

The combination filter and pollen filter are marked on the upper side with the letter "C" or "P".



! You may only knock the coarse filter clean and/or blow it with compressed air.

The coarse filter is clearly marked on the upper side with the letter "B".

Maintain a distance of at least 20 cm between the air jet and the filter when blowing with compressed air. Carefully knock and/or blow the coarse filter clean in the opposite direction to the airflow. The direction of the airflow is indicated by arrows on the upper side of the coarse filter.

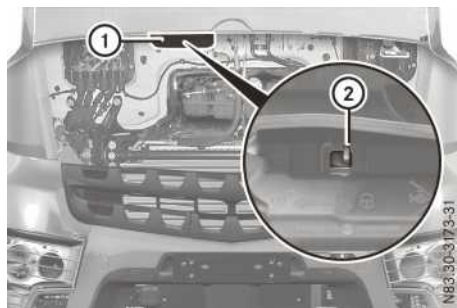
Careless or incorrect cleaning may damage the coarse filter.



- ▶ Open the maintenance flap.
- ▶ Slide catch (2) on air intake slot (1) in the direction of .
- ▶ Remove air intake slot (1).
- ▶ Pull the coarse filter from the slot.
- ▶ Knock or blow the coarse filter clean.
- ▶ Slide the coarse filter into the slot. Take note of the airflow direction indicated by arrows on the upper side. The arrows must point downwards.
- ▶ Attach air intake slot (1).
- ▶ Slide catch (2) on air intake slot (1) in the direction of .

Replacing the wiper blades

WARNING

If you use the steps and grab handles at the front of the cab when replacing the wiper blades, you could slip and/or fall. There is a risk of injury.

When replacing the wiper blades, always use secure climbing aids, e.g. a suitable ladder.

WARNING

If the windscreen wipers begin to move while you are changing the wiper blades, you can be trapped by the wiper arm. There is a risk of injury.

Always switch off the windscreen wipers and ignition before changing the wiper blades.

 Only touch the wiper blade on the wiper arm. Otherwise, you could damage the wiper blade.

 Do not open the maintenance flap when a wiper arm is folded away from the windscreen. Otherwise, you could damage the maintenance flap.

Do not fold the wiper arms back onto the windscreen without wiper blades fitted. Otherwise, you could damage the windscreen.

Wiper blades are wear parts. Replace wiper blades once a year. Otherwise, the windscreen and rear window will not be wiped properly.

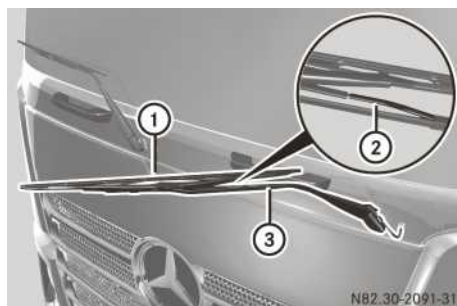

Do not remove the pipe jet from the wiper blade. Always replace the wiper blades together with the pipe jets.

- ▶ Apply the parking brake.
- ▶ Shift the transmission to neutral position **N**.
- ▶ Switch off the engine.
- ▶ Remove the key from the ignition lock.
- ▶ **To remove the wiper blade:** fold wiper arm (3) away from the windscreen.
- ▶ Remove hose (2) from the pipe jet.
- ▶ Set wiper blade (1) at a right angle to the wiper arm.

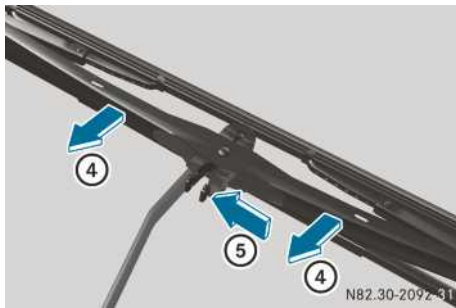

- ▶ Press locking springs ⑤ together and push wiper blade ① out of the curvature of wiper arm ③ in the direction of arrow ④.
- ▶ Remove wiper blade ①.

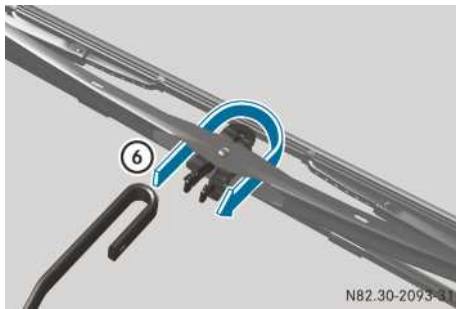

- ▶ **To fit a wiper blade:** slide the hinge piece of the wiper blade into the bend of wiper arm ③ in the direction of arrow ⑥.
- ▶ Press the wiper blade into the curvature on wiper arm ③ until the locking springs engage audibly.
- ▶ Turn wiper blade ① parallel to wiper arm ③.
- ▶ Slide hose ② onto the pipe jet. Ensure that hose ② is firmly fitted onto the pipe jet.
- ▶ Fold wiper arm ③ onto the windscreen again.

Engine oil level

Checking the engine oil level

Check the engine oil level before the start of every journey.

- ▶ Check the oil level using the on-board computer (▷ page 148).
- ▶ Top up the oil as shown in the on-board computer.

Topping up the engine oil

⚠ Only use oils which have been approved for the vehicle and with the prescribed SAE classification.

Do not add too much oil. If you add too much oil, the engine or the exhaust system could be damaged. Have excess oil siphoned off.

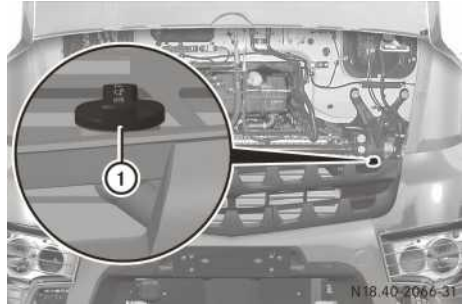

Example: cap

Do not add the topping-up quantity shown in the on-board computer until the menu window shows the  symbol.

You will find information about engine oils in the "Service products" section (▷ page 419).

- ▶ Park the vehicle on a level surface.
- ▶ Apply the parking brake.
- ▶ Switch off the engine.
- ▶ Open the maintenance flap (▷ page 355).
- ▶ Unscrew and remove black cap ①.
- ▶ Top up the oil as shown in the on-board computer.
- ▶ Replace black cap ① and screw it on.
- ▶ Close the maintenance flap.

Oil level in the automatic transmission

General notes

⚠ If the  indicator lamp is lit or flashing while driving, the temperature of the transmission oil or coolant is too high. The reason for this may be that the transmission oil level is too high or too low. If the transmission fluid temperature is frequently too high, there is a risk of damage to the transmission.

Only check the oil level when the automatic transmission is at normal operating temperature.

Checking the oil level in the display

Starting oil level measurement



- ▶ Park the vehicle on a level surface.
- ▶ Apply the parking brake.
- ▶ Shift the automatic transmission to the neutral position.
- ▶ Start the engine and leave it running at idling speed.
- ▶ Press buttons ② and ③ at the same time. Press button ②. The oil level measurement starts. During oil level measurement, display ① shows the codes **oL 08** to **oL 01** in succession.
- ▶ Wait approximately 2 minutes. After a delay, display ① automatically shows a code for the oil level or a fault code.

Codes that can be shown in the display

Codes for the oil level:

Code	Meaning
oL oK	The oil level in the transmission is sufficient.
oL Lo	The oil level in the transmission is too low.
	The number subsequently displayed indicates the transmission oil quantity that must be refilled, for example 01 = 1 litre.

Code	Meaning
oL HI	The oil level in the transmission is too high.
	The number subsequently displayed indicates the transmission oil quantity that must be drained or siphoned off, for example 01 = 1 litre.

Possible fault codes during the oil level measurement:

Code	Meaning	Remedy
oL EL	The engine speed is too low.	▶ Leave the engine running at idling speed.
oL EH	The engine speed is too high.	▶ Leave the engine running at idling speed.
oL SN	The automatic transmission is not in the neutral position.	▶ Shift the automatic transmission to the neutral position.
oL TL	The oil temperature is too low.	▶ Leave the engine running until the transmission oil reaches operating temperature.
oL TH	The oil temperature is too high.	▶ Switch off the engine until the oil temperature in the transmission has dropped to operating temperature.

Code	Meaning	Remedy
oL SH	The vehicle is rolling.	<ul style="list-style-type: none"> ▶ Stop the vehicle. ▶ Apply the parking brake.
oL FL	The sensor for the oil level is malfunctioning.	<ul style="list-style-type: none"> ▶ Check the oil level with the oil dipstick. ▶ Have the malfunction checked at a qualified specialist workshop.

Ending oil level measurement

- ▶ Press any gear button.
The oil level measurement is finished. The shift position appears on the left and the selected gear appears on the right in display ① again.
- ▶ Top up the transmission oil if necessary.

Vehicle assemblies

Environmental note

Improper handling of service products is hazardous to the environment.

Do not allow service products to enter the sewage system, surface waters, ground water or soil.

Check the vehicle assemblies for leaks regularly. If fluid loss is identified, e.g. through oil drops on the parking area, have the cause of the fluid loss rectified at a qualified specialist workshop.

Checking the anti-corrosion protection

! Road salt has a corrosive effect. In winter, wash the vehicle more frequently in order to remove salt residue. Salt residues can otherwise damage the anti-corrosion protection.

The vehicle can be provided with Mercedes-Benz protective chassis sealing. The Mercedes-Benz protective chassis sealing is a transparent

anti-corrosion wax with outstanding protective qualities.

All Mercedes-Benz cabs have body cavity protection.

- ▶ Check the vehicle regularly for corrosion damage, particularly the compressed-air lines, hydraulic lines and electrical contact points (earth contacts).
- ▶ Have any damage to the factory-fitted anti-corrosion protection rectified at a qualified specialist workshop.
- ▶ Vehicles without Mercedes-Benz protective chassis sealing: as a precautionary measure, spray the underside of the vehicle with a wax-based underbody protective agent according to Sheet No. 385.1 of the Mercedes-Benz Specification for Service Products.

Batteries

Important safety notes

WARNING

Battery acid is caustic. There is a risk of injury. Avoid contact with skin, eyes or clothing. Do not inhale any gases released from the battery. When carrying out maintenance work on the battery, wear acid-resistant protective clothing, particularly protective eyewear, protective gloves and an apron. Do not lean over the battery. Keep the batteries out of the reach of children.

If you come into contact with battery acid, observe the following:

- immediately rinse battery acid off skin thoroughly with clean water and seek immediate medical attention.
- if you get battery acid in your eyes, rinse them thoroughly with clean water immediately. Consult a doctor without delay.

Environmental note



Batteries contain pollutants. It is illegal to dispose of them with the household rubbish. They must be collected separately and disposed of in an



environmentally responsible recycling system.

Dispose of batteries in an environmentally responsible manner. Take discharged batteries to a qualified specialist workshop or to a collection point for used batteries.

Observe the safety notes and protective measures when handling the battery.



Risk of explosion. Explosive oxygen is produced when batteries are being charged. Only charge the batteries in a well-ventilated area.



Risk of explosion. Avoid creating sparks. Avoid fire, open flames and do not smoke when handling the battery.



Battery acid is caustic. Wear acid-resistant protective gloves. Splashes of acid on skin or clothing should be neutralised immediately using soapy water or acid neutraliser and then rinsed with water.



Wear eye protection. When mixing water and acid, the liquid may splash into your eyes. Rinse out any acid that splashes into eyes immediately using clean water and seek medical attention at once.



Keep out of the reach of children. Children are not able to evaluate the risk involved in handling batteries and acid.



Always observe the safety instructions, protective measures and procedures specified in these Operating Instructions when handling the battery.

For safety reasons, Mercedes-Benz recommends that you only use batteries that have been tested and approved for your vehicle by Mercedes-Benz.

Battery compartment

Cover

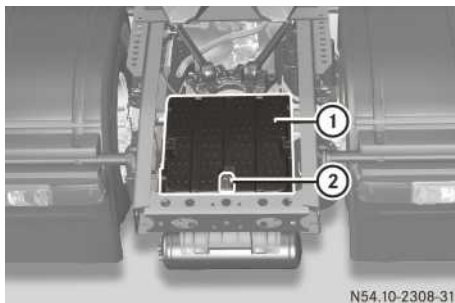

N54.10-2308-31

Battery compartment cover (example: tractor/ semitrailer combination)

- ▶ **To remove:** open catch ② and remove battery compartment cover ① upward.
- ▶ **To replace:** replace battery compartment cover ①. Attach catch ② and close.

Arrangement of the batteries

The location of the batteries may vary depending on the vehicle version. The batteries may be fitted one beside the other or one on top of the other in the rear area between the longitudinal members of the chassis members or on the side on the chassis.

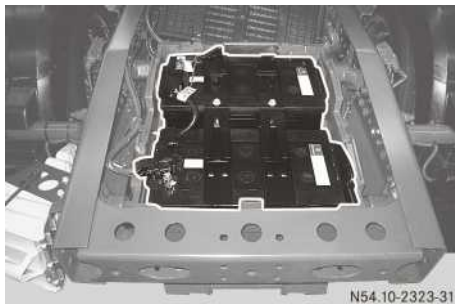

N54.10-2323-31

Example: batteries in the chassis



Example: batteries on the side on the chassis, one beside the other

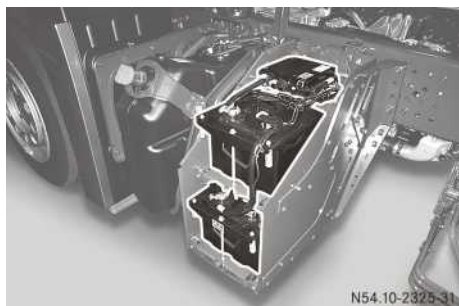

Example: batteries on the side on the chassis, one above the other

Disconnecting and connecting the batteries

WARNING

During the charging process, a battery produces hydrogen gas. If a short circuit occurs or sparks are created, the hydrogen gas can ignite. There is a risk of an explosion.

- Make sure that the positive terminal of a connected battery does not come into contact with vehicle parts.
- Never place metal objects or tools on a battery.
- It is important that you observe the described order of the battery terminals when connecting and disconnecting a battery.
- When jump-starting, make sure that the battery poles with identical polarity are connected.

- It is particularly important to observe the described order when connecting and disconnecting the jump leads.
- Never connect or disconnect the battery terminals while the engine is running.

! On vehicles with a battery sensor, the negative terminal clamp forms part of the battery sensor. Tighten the negative terminal clamp on the battery pole to a torque of $7 \text{ Nm} \pm 1 \text{ Nm}$. Otherwise, contact is not ensured and you may damage the terminal clamp, the battery pole or the battery sensor.

Observe the safety notes on handling batteries. Before disconnecting and connecting the batteries:

- ▶ Semitrailer tractor vehicle with batteries at the rear area: detach the semitrailer (▷ page 324).
- ▶ Remove the key from the ignition lock.
- ▶ Switch off all electrical consumers.

Disconnecting

- ▶ Remove the battery compartment cover.
- ▶ Disconnect the negative terminal clamp first, and then disconnect the positive terminal clamp.

Connecting

- ▶ Connect the positive terminal clamp first, and then connect the negative terminal clamp. Do not interchange the battery terminals.
- ▶ Replace the battery compartment cover.

Carry out the following tasks after an interruption to the power supply or after reconnecting the batteries:

- ▶ Reset the side window (▷ page 68) and the sliding sunroof (▷ page 70).
- ▶ Deactivate anti-theft protection on the audio equipment (radio) (▷ page 215).
- ▶ Set the local time on the tachograph.
- ▶ Set the switch-on time for the auxiliary heating system (▷ page 125).

Removing/fitting batteries

Important safety notes

! On vehicles with a battery sensor, the negative terminal clamp forms part of the battery sensor. Tighten the negative terminal clamp on the battery pole to a torque of 7 Nm \pm 1 Nm. Otherwise, contact is not ensured and you may damage the terminal clamp, the battery pole or the battery sensor.

Observe the safety notes on handling batteries.

Batteries fitted one above the other

! Tighten the battery carrier screws to a tightening torque of 12 Nm. Do not use an impact wrench. Otherwise, you could damage the bolted connection.

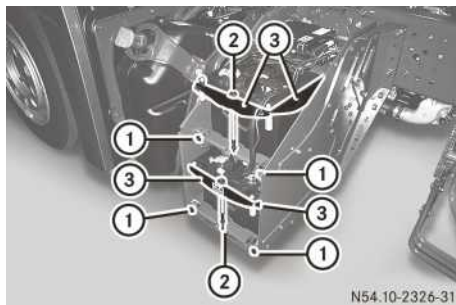

Batteries mounted on the side of the chassis, one above the other (example: platform truck)

Removing

- ▶ Remove the battery compartment cover.
- ▶ Disconnect the negative terminal clamp first, and then disconnect the positive terminal clamp.
- ▶ Detach the connecting cables between the batteries.
- ▶ Unscrew bolts ① from the upper battery carrier.
- ▶ Pull out the upper battery carrier.
- ▶ Unscrew bolt ② from upper securing frame ③.
- ▶ Remove securing frame ③.
- ▶ Pull out the upper battery and the upper battery carrier.
- ▶ Unscrew bolts ① from the lower battery carrier.
- ▶ Pull out the lower battery carrier.

- ▶ Unscrew bolt ② from lower securing frame ③.
- ▶ Remove lower securing frame ③.
- ▶ Remove the lower battery and the lower battery carrier.

Fitting

- ▶ Insert the lower battery carrier.
- ▶ Set the battery onto the lower battery carrier.
- ▶ Position lower securing frame ③ and screw in bolts ②.
- ▶ Push in the lower battery carrier.
- ▶ Screw bolts ① into the lower battery carrier.
- ▶ Insert the upper battery carrier.
- ▶ Place the battery on the upper battery carrier.
- ▶ Position upper securing frame ③ and screw in bolts ②.
- ▶ Push in the upper battery carrier.
- ▶ Screw in bolts ① to the upper battery carrier.
- ▶ Connect the connecting cables between the batteries.
- ▶ Connect the positive terminal clamp first, and then connect the negative terminal clamp.
- ▶ Replace the battery compartment cover.

Batteries fitted one beside the other

! Tighten the bolts of the battery support frame to a tightening torque of 20 Nm. Do not use an impact wrench. You could otherwise damage the threads.

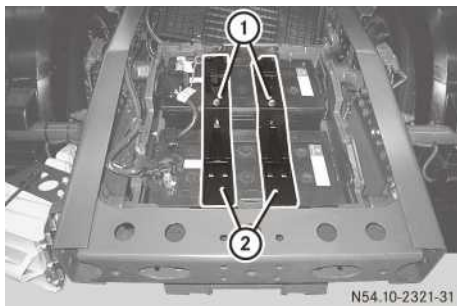

Batteries in the chassis, one beside the other (example: tractor/semitrailer combination)

Removing

- ▶ Remove the battery compartment cover.
- ▶ Disconnect the negative terminal clamp first, and then disconnect the positive terminal clamp.

- ▶ Detach the connecting cables between the batteries.
- ▶ Unscrew bolts ① from brackets ②.
- ▶ Remove both brackets ②.
- ▶ Remove the batteries.

Fitting

- ▶ Insert the batteries.
- ▶ Insert both brackets ②.
- ▶ Screw bolts ① into brackets ②.
- ▶ Connect the connecting cables between the batteries.
- ▶ Connect the positive terminal clamp first, and then connect the negative terminal clamp.
- ▶ Replace the battery compartment cover.

Maintenance and care

General notes

In this section you will find notes and information about the batteries. This means you can ensure that the batteries are charged and ready for use.

Battery capacity and power

- Battery capacity is limited and operating time depends on the number of electrical consumers that are switched on and the duration used.
- The given nominal capacity of the battery may be higher than the actual battery capacity. Battery capacity depends on:
 - the age of the battery
 - the outside temperature
 - the engine speed
- Regardless of the power of the alternator, the battery can only be charged a certain amount per hour. The rate of charge is significantly reduced by low outside temperatures. As a result, the battery may take much longer to charge in winter.
- Please note that the alternator cannot fully charge the batteries.
- If the battery is used intensively when the vehicle is stationary, e.g. remaining in the vehicle overnight, recharging the battery may be required after several days.

Example:

If the coolbox consumes approximately 1 A in one hour and remains switched on over a

weekend, this results in an overall consumption of approximately 60 Ah.

- To ensure the ability to start the vehicle, observe the notes and instructions in the following event windows:
 - [Consumer shutoff active](#)
 - [Battery charge level low](#)
 - [Battery charge level too low Start engine](#)

Parking up the vehicle for an extended time period and storage

! Disconnect the negative terminal of the battery when the vehicle is to be idle for longer than 1 week. This prevents the battery from being discharged or damaged.

! For idle times of longer than 1 month, remove the battery and store it in a dry place at temperatures between 0 °C and 30 °C. Maintain a constant battery voltage of 12.6 V. If the battery voltage falls below 12.1 V, the battery is damaged and must be replaced.

Charge the battery when the no-load voltage is under 12.6 V. This ensures that the vehicle can always be started.

If you park up your vehicle for longer than 3 weeks, observe the notes on parking up your vehicle (▷ page 368).

When storing the battery, comply with all safety regulations, such as operating instructions, regulations concerning hazardous materials, environmental protection measures, work safety and accident prevention regulations.

Replacing the battery and operating life

! Do not connect any electrical consumers directly to the battery terminals. This leads to uncontrolled discharge of the battery and erroneous sensing of charge requirements by the battery sensor. Current drain in one battery results in damage being caused to both batteries.

Avoid the battery becoming fully discharged. This can significantly reduce the operating life of the battery.

Long battery service life can be achieved by keeping the batteries adequately charged.

Mercedes-Benz recommends the following when replacing the batteries:

- always replace both batteries
- use the same type of battery

If you use another type of battery, have the battery type set with a diagnostic tester by a qualified specialist workshop.

- use batteries of the same age
- Do not combine old and new batteries.

Checking the battery charge level

If the vehicle is used often or predominantly over short distances or is parked for a long period, check the battery charge level more often.

- ▶ Disconnect the batteries.
- ▶ Wait for approximately 8 seconds.
- ▶ Measure the no-load voltage of the battery.
- ▶ If the no-load voltage of the battery is over 12.6 V, reconnect the battery.
- ▶ If the no-load voltage of the battery is under 12.6 V, charge the battery separately.

Charging the batteries

WARNING

During charging and jump-starting, explosive gases can escape from the battery. There is a risk of an explosion.

Particularly avoid fire, naked flames, creating sparks and smoking. Ensure there is sufficient ventilation while charging and jump-starting. Do not lean over a battery.

WARNING

A discharged battery can freeze at temperatures below freezing point. When jump-starting the vehicle or charging the battery, gases can escape from the battery. There is a risk of an explosion.

Allow the frozen battery to thaw out before charging it or jump-starting.

- !** Use a commercially-available battery charger to charge the batteries. Make sure that the charging voltage is correct. Do not charge new batteries with rapid charging. The charge current of used batteries should be maximum 75% of the battery capacity for rapid charging. Otherwise, you could damage the batteries.

- !** The charge current should not exceed 10% of the battery capacity. A higher charge current can damage the batteries.

Charge the batteries when the outside temperature is above 0 °C. The optimal outside temperature is between 10 °C and 25 °C.

- ▶ Remove the batteries.
- ▶ Unscrew the battery cell caps.
- ▶ Check the battery fluid level.
- ▶ Charge the batteries separately.
- ▶ Connect and switch on the battery charger. See the battery charger's operating instructions.
- ▶ If the batteries are charged, deactivate the battery charger and screw the plugs into the batteries.
- ▶ Fit the batteries.

- i** After charging/replacing the batteries, the battery charge level calculated may not be correct. It takes approximately 3 days while the vehicle is in operation for the teach-in process to be completed.

The following event window displays are only correct once the teach-in process has been completed:

- Consumer shutoff active
- Battery charge level low
- Battery charge level too low Start engine

Checking the battery fluid level

- !** Tap water reduces the electrical power output of the batteries. Add only distilled or deionised water.

Do not use a metal funnel when adding distilled water. The metal funnel may cause a short circuit and the batteries may be damaged.

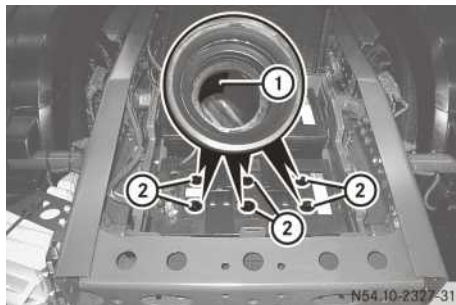

Batteries in the chassis, one beside the other (example: tractor/semitrailer combination)

Observe the safety notes on handling batteries.

- ▶ Check the battery fluid level as regularly as required by the vehicle operating conditions, and at least once a year.
- ▶ Remove the battery compartment cover.
- ▶ Vehicles with batteries fitted one above the other: remove the batteries.
- ▶ Unscrew cell caps ②.
- ▶ Check the battery fluid level.
The battery fluid must reach marker bar ① in each battery cell.
- ▶ Top up with distilled/de-ionised water.
- ▶ Refit cell caps ②.
- ▶ Vehicles with batteries fitted one above the other: fit the batteries.
- ▶ Replace the battery compartment cover.

Battery care

- ❗ Dirty battery terminals and battery surfaces cause creepage current. This can cause the batteries to discharge.
- ❗ Do not use any cleaning agents containing fuel. Cleaning agents containing fuel corrode the battery housing.
- ❗ If dirt enters the battery cell, self-discharging of the battery is increased and the battery may be damaged.

Observe the following on battery care:

- ▶ Always keep the terminal clamps and battery surfaces clean and dry.
- ▶ Lightly grease the undersides of the battery terminal clamps with acid-resistant grease.
- ▶ Only clean the batteries with the cell caps screwed in.
Otherwise, dirt can enter the battery cells.
- ▶ Only clean the battery housing with commercially available cleaning agents.

Parking up the vehicle

When parking up the vehicle, special measures according to Mercedes-Benz Specifications for Service Products Sheet No. 382.0 need to be taken.

You can obtain detailed information from any Mercedes-Benz Service Centre.

Useful information

These Operating Instructions describe all the models and standard and optional equipment of your vehicle that were available at the time of going to print. Country-specific differences are possible. Bear in mind that your vehicle may not be equipped with all the functions described. This also applies to safety-relevant systems and functions.

Read the information on qualified specialist workshops (▷ page 31).

Telediagnosis

With telediagnosis, you can provide Mercedes-Benz Service 24h with detailed technical information on your vehicle in the event of a breakdown. This allows Mercedes-Benz Service 24h to isolate the malfunction and quickly provide you with assistance.

You can use telediagnosis if you have activated FleetBoard® and have a completed framework agreement with the "Uptime" service.

The following data is transmitted to Mercedes-Benz Service 24h:

- data necessary for identification of the vehicle (e.g. vehicle identification number/VIN)
- control unit diagnosis data (e.g. malfunction message memory)
- current data on the vehicle position
- the current total distance

No data related to the driver, the route or the load are transmitted.

If you press the FleetBoard® TiiRec Service Call button for approximately 2 seconds, telediagnosis is activated (▷ page 191).

- i** If you activate telediagnosis and do not notify Mercedes-Benz Service 24h, the data is deleted after 72 hours.

Where will I find...?

Tool kit compartment

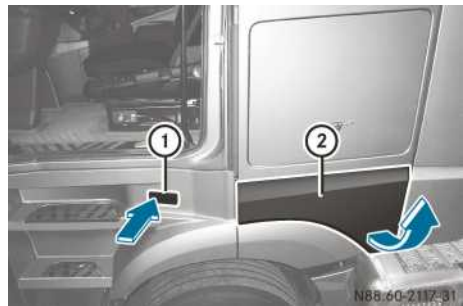

Tool kit compartment (example: L cab)

The tool kit compartment is at the side of the cab above the wheel arch and only accessible from the outside.

Opening the tool kit compartment

- ▶ Press release catch ① on the outside in the recess.
Exterior flap ② opens until stopped by the retaining hook.
- ▶ Press release catch ① again on the outside in the recess.
Exterior flap ② is fully unlocked. The tool kit compartment lighting comes on automatically.
- ▶ Swing exterior flap ② up fully using the recess on the right-hand side.
The prop rods engage.

Closing the tool kit compartment

- ▶ Raise exterior flap ② a small amount by the recess.
- ▶ Push up the prop rod.
- ▶ Swing exterior flap ② down by the recess on the right-hand side until you hear it engage in the lock.
The tool kit compartment lighting goes out automatically.

Vehicle tool kit and emergency equipment

Important safety notes

When working on the vehicle, comply with all safety regulations, such as the Operating Instructions, regulations concerning hazardous

materials, environmental protection measures, work safety and accident prevention regulations.

Overview

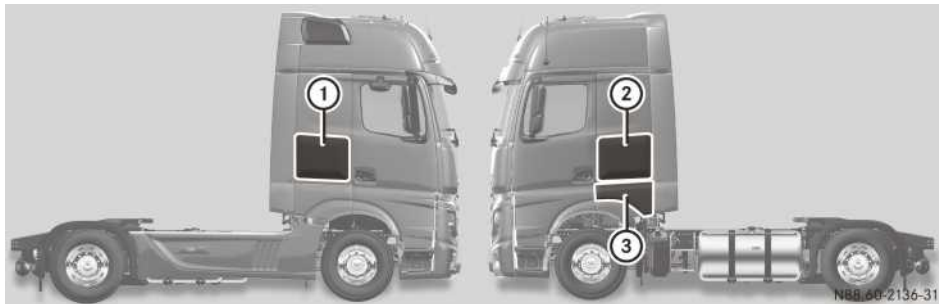

Stowage compartments and tool kit compartment (example: tractor/semi-trailer combination with L cab)

The vehicle tools and emergency equipment are divided into two packages:

A	B
<ul style="list-style-type: none"> • Spare bulbs • Fire extinguisher • Tyre pressure gauge • Tyre inflater hose • Support block • Second warning triangle 	<ul style="list-style-type: none"> • Towing eye • Spare wheel spacer • Vehicle tool kit • Hand crank • Lamps with 10 m cable • Assembly lever • Pump lever • Jack

Allocation of vehicle tools and emergency equipment for L and M cabs:

	①	②	③
L cab with tool kit compartment	B		A
L cab with tool kit compartment and SoloStar Concept		B	A
L cab without tool kit compartment and with SoloStar Concept		A / B	
L cab without tool kit compartment	A / B		
M cab	A	B	

Vehicles with ADR classification: the fire extinguisher is located in stowage compartment ② on the driver's side. Open the stowage compartment (▷ page 109).

On vehicles with 2 fire extinguishers, the second fire extinguisher may be in the following storage locations, depending on the vehicle version:

- in stowage compartment ① on the co-driver's side
- in tool kit compartment ③ (▷ page 369)
- in a protective box on the exterior of the rear wall on the driver's side

On the L cab as car transporter: with lowered berth or seat/berth combination, the fire extinguisher and jack are behind the driver's seat. You are responsible for stowing the tools yourself.

On the S cab, the jack is on the B-pillar behind the co-driver; the vehicle tool kit is behind the driver's seat. For all vehicles except those on the French market, the fire extinguisher is on the engine tunnel on the rear wall. For vehicles on the French market, the fire extinguisher is on the A-pillar on the co-driver's side. You are responsible for stowing the tools yourself.

The following emergency equipment is found in the stowage space in the driver's door:

- first-aid kit
- warning triangle
- warning beacon
- reflective safety vest

Jack

i Depending on the equipment, the jack has a maximum weight of 15.9 kg.

The maximum jack payload can be found on the sticker attached to the jack.

Following a malfunction, please contact a qualified specialist workshop.

Jack maintenance

- ▶ **After usage:** clean all moving parts and reapply grease to them.
- ▶ **Every six months:** completely extend and retract the piston.

Pump lever (2-part)

WARNING

If you do not assemble the pump lever as described, the handle can slip out of the guide while pumping. There is a risk of injury.

Make sure that the locking pin of the pump lever is engaged in the hole intended for the purpose.

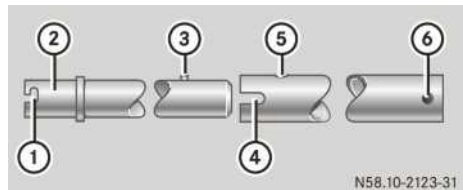

- ① Recess (jack)
- ② Jacking point (wheel wrench/cab tilt pump)
- ③ Retaining pin
- ④ Recess (for operating the winch and jack)
- ⑤ Hole for retaining pin
- ⑥ Retaining sleeve for inserting the hand crank (spare wheel hoist)

Use the pump lever to operate:

- the jack
 - the wheel wrench
 - the spare wheel winch
 - the cab tilt pump
- ▶ **To assemble the pump lever:** align and insert retaining pin ③ into hole ⑤ of both pump lever parts.
 - ▶ Press retaining pin ③ into hole ⑤ until it engages.
 - ▶ **To disassemble the pump lever:** press locking pin ③ and pull apart the pump lever.

Wheel chock

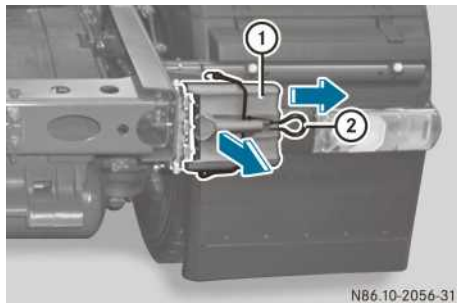

Example: tractor/semitrailer combination, wheel chock

Depending on the vehicle version and equipment, the storage location of the wheel chocks may vary.

Removing the wheel chock

- ▶ Pull the elastic strap over retainer ②.
- ▶ Press and hold retainer ② in the direction of the arrow.
- ▶ Pull out wheel chock ①.
- ▶ Release retainer ②.

Inserting the wheel chock

- ▶ Press and hold retainer ② in the direction of the arrow.
- ▶ Insert wheel chock ① into the bracket.
- ▶ Release retainer ②.
- ▶ Pull the elastic strap over and beyond retainer ② and onto wheel chock ①.

Cab

Before tilting the cab

WARNING

When the cab is being tilted, it could suddenly fall forwards to its end position or out-of-use position. There is a risk of injury for persons in the tipping range of the cab.

Only tilt the cab when there are no persons within the tilting range. Do not remain in the area underneath the cab when the cab is tilted.

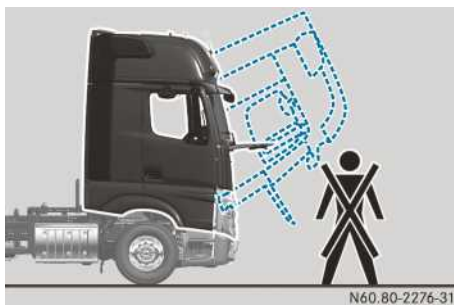

Tilting area of the cab (example: Actros)

Before tilting the cab, carry out the following steps:

- ▶ For safety reasons, keep the area in front of the cab unobstructed.
- ▶ Apply the parking brake.
- ▶ Shift into neutral.
- ▶ For air-sprung cabs: allow the engine to continue running until the compressed-air system is filled to the maximum and the compressor switches off.
- ▶ Switch off the engine.
- ▶ To start the engine after tilting the cab, turn the key in the ignition to the drive position.
- ▶ Switch off the auxiliary heating system (▷ page 125).
- ▶ Switch off the auxiliary air conditioning (▷ page 123).
- ▶ Switch off the coolbox (▷ page 109).

i Observe the separate operating instructions of the coolbox. You may switch the coolbox on again 10 minutes after tilting back the cab.

- ▶ Remove all loose objects from the cab, for example:
 - drink cans
 - bottles
 - tools
 - bags
- ▶ Close the stowage compartments on the inside (▷ page 107) and the tool kit compartment on the outside (▷ page 369).
- ▶ Close the doors.

i If you need to open a door when the cab is open, do so carefully and slowly until the door is fully open.

- ▶ Make sure the coupling pin of the front coupling jaw is secure and that the coupling jaw is covered (▷ page 398).
- ▶ Use chocks to safeguard the vehicle against rolling away.

Mechanical-hydraulic cab tilting unit

Tilting the cab forwards

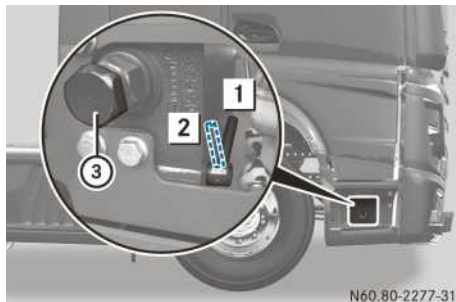

Cab tilting pump, in doorway on the right-hand side (example: Actros)

- 1 Drive position
- 2 Tilting position
- 3 Hexagon nut

Do not step on the engine when the cab is tilted.

- ▶ Before tilting the cab, observe the notes (▷ page 372).
- ▶ Open the maintenance flap (▷ page 355).
- ▶ Swing up the flap on the right-hand side of the doorway.
- ▶ Swing valve lever on the tilting pump to position **2**.
- ▶ Fit the pump lever to hexagon nut **3** on the tilting pump using the wheel wrench (vehicle tool kit).
- ▶ Move the pump lever up and down on the tilting pump until the cab tilts into the front end position.
The cab is unlocked automatically.
- ▶ If there is noticeable resistance when you operate the pump lever, check that tilting position **2** has been set correctly on the valve lever on the tilting pump.
- ▶ If there is no noticeable resistance when you operate the pump lever, have the tilting hydraulics checked at a qualified specialist workshop.

Tilting the cab back into the driving position

WARNING



If the cab is not locked, the following dangerous situations could arise when the vehicle decelerates:

- it could tilt forwards
- you could lose control of the vehicle
- persons in the cab could be thrown forwards
- persons or objects in the swinging range could be hit

There is a risk of an accident and injury.

Before every journey, make sure that:

- the cab is locked
- the cab is engaged in driving position and the valve lever is in driving position
- the indicator lamp goes out when the engine is started

- ▶ Swing the valve lever on the tilting pump to driving position **1**.
- ▶ Fit the pump lever with the wheel wrench to hexagon nut **3** on the tilting pump.
- ▶ Move the pump lever up and down on the tilting pump until the cab is tipped into the rear end position.
The catch engages audibly and the cab automatically locks.
Do not continue to operate the pump lever on the tilting pump once the cab is locked in position.
- ▶ Close the maintenance flap.
- ▶ Swing the flap in the right-hand entry area down until you hear it engage.
- ▶ Make sure that the  indicator lamp in the instrument cluster goes out after you start the engine.
When the  indicator lamp goes out, the cab is locked. If the  indicator lamp does not go out, repeat the process and tip the cab back again.

Electrohydraulic cab tilting unit

Tilting the cab forwards



- ▶ Before tilting the cab, observe the notes (> page 372).
- ▶ Press the upper section of the button. The indicator lamp in the button lights up. The cab tilting pump is switched on.

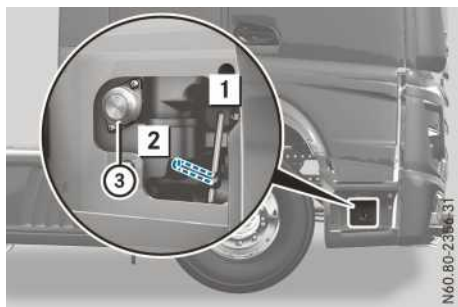

Cab tilting pump, in doorway on the right-hand side (example: Actros)

- 1 Valve lever in driving position
- 2 Valve lever in tilting position
- 3 Button

Do not step on the engine when the cab is tilted.

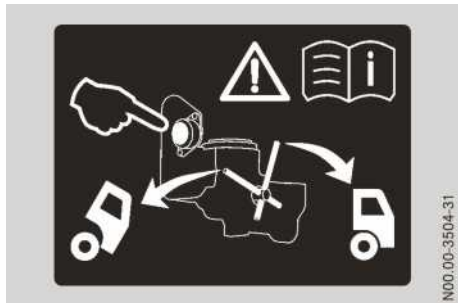

Instruction sticker in the door frame

- ▶ Swing up the flap on the right-hand side of the door frame.
- ▶ Check the direction of rotation of the valve lever on the instruction sticker in the door frame.
- ▶ Swing the valve lever on the cab tilting pump to position 2.
- ▶ Press and hold button 3 until the cab has tilted to the front end position. The cab has reached its end position when the pump sound becomes louder.

Tilting the cab back into the driving position

WARNING

If the cab is not locked, the following dangerous situations could arise when the vehicle decelerates:





- it could tilt forwards
- you could lose control of the vehicle
- persons in the cab could be thrown forwards
- persons or objects in the swinging range could be hit

There is a risk of an accident and injury.

Before every journey, make sure that:

- the cab is locked
- the cab is engaged in driving position and the valve lever is in driving position
- the indicator lamp goes out when the engine is started

- ▶ Swing the valve lever on the cab tilting pump to driving position 1.
- ▶ Press and hold button 3 until the cab has tilted to the rear end position. The cab locks automatically.
- ▶ Swing the flap in the right-hand door frame area down until you hear it engage.

- ▶ In the cab, press the lower section of the  button.
The indicator lamp in the  button goes out.
- ▶ Make sure that the  indicator lamp in the instrument cluster goes out after you start the engine.
When the  indicator lamp goes out, the cab is locked. If the  indicator lamp does



not go out, repeat the process and tip the cab back again.

Problems when tilting the cab

Mechanical-hydraulic cab tilting unit

Problem	Possible causes/consequences and ► Solutions
The cab cannot be tilted.	The valve lever of the mechanical-hydraulic cab tilting pump is in the "Tilt back in driving position". ▶ Turn the valve lever of the mechanical-hydraulic cab tilting pump so that it points towards the "Tilt forward" position (▷ page 373).
	The tilting hydraulics are leaking or have failed. ▶ Have the tilting hydraulics repaired at a qualified specialist workshop.

Electrohydraulic cab tilting unit

Problem	Possible causes/consequences and ► Solutions
The cab cannot be tilted.	The cab tilting system is not switched on. ▶ In the cab, press the upper section of the  button. (▷ page 374). The indicator lamp in the  button lights up.
	The fuse for the cab tilting pump has blown. ▶ Replace the fuse for the cab tilting pump in module A1 in the main fuse carrier (▷ page 387).
	The tilting hydraulics are leaking or have failed. ▶ Have the tilting hydraulics repaired at a qualified specialist workshop.

Engine

Starting and stopping the engine with the cab tilted

WARNING

There are moving components in the engine compartment. Certain components may continue to move or suddenly move again even after the ignition has been switched off, e.g. the radiator fan. There is a risk of injury.

If you have to carry out work in the engine compartment:

- switch off the ignition
- never touch the dangerous areas surrounding moving components, e.g. the rotation area of the fan
- remove jewellery and watches
- keep items of clothing and hair, for example, away from moving parts.

WARNING

Certain engine components can become very hot. There is a risk of injury when carrying out work at the engine.

Where possible, allow the engine to cool down and only touch the components described below.

Be aware of the road and traffic situation when working on public roads and secure your position accordingly.

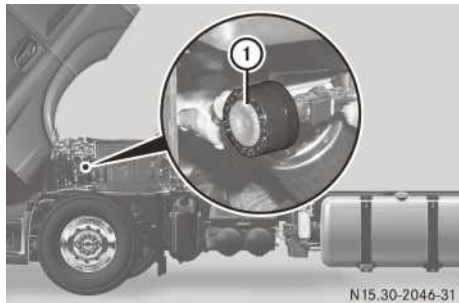

N15.30-2046-31

Before the engine is switched on

- ▶ Apply the parking brake.
- ▶ Switch the ignition lock to the drive position.

- ▶ Shift into neutral.
- ▶ Tilt the cab forwards (electrohydraulic (▷ page 374) or mechanical hydraulic (▷ page 373) cab tilt system).

Starting the engine

- ▶ Press external engine start/engine stop  until the engine starts.

Starting the engine and increasing the engine speed

- ▶ Hold down external engine start/engine stop  until the desired engine speed is achieved.

After about 3 seconds, the engine speed increases. After external engine start/engine stop  has been released, the engine continues to run at the speed currently set.

The engine speed can be increased up to the limiting speed.

Stopping the engine

- ▶ Press external engine start/engine stop  again.
- ▶ Tilt the cab back to the driving position.

Bleeding the fuel system

Bleeding the fuel system without fuel prefilter on chassis frame (OM 460 only)

- ⚠ Do not bleed the fuel system with several starting procedures. You could otherwise damage the starter motor.

- ▶ Apply the parking brake.
- ▶ Switch the ignition lock to the drive position.
- ▶ Shift into neutral.
- ▶ Tilt the cab forwards (electrohydraulic (▷ page 374) or mechanical hydraulic (▷ page 373) cab tilt system).
- ▶ Unscrew the fuel tank filler cap.

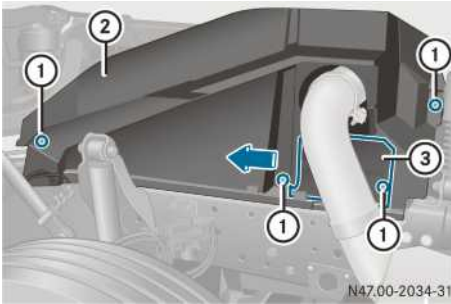

- ▶ Unscrew fasteners ①.
- ▶ Slide cap ③ to the side and remove cover ②.

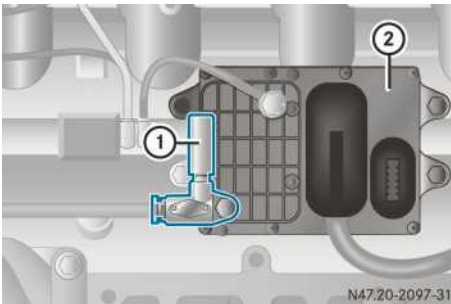

When the fuel pressure has been built up using hand pump ① on the main filter, you must start the engine within approximately five seconds. Otherwise, the fuel pressure decreases and you will have to repeat the procedure.

- ▶ Push hand pump ① on engine control unit ② repeatedly (approximately 100 times), until you hear the overflow valve open.
- ▶ Press the external engine start/engine stop switch (▷ page 376) within approximately five seconds and start the engine.
- ▶ If the engine starts: leave the engine running at an increased engine speed.
- ▶ If the engine does not start: repeat the procedure.
- ▶ Tilt the cab forwards (electrohydraulic (▷ page 374) or mechanical hydraulic (▷ page 373) cab tilt system).
- ▶ Tighten the fuel tank filler cap.
- ▶ Replace the cover.

Bleeding the fuel system without fuel prefilter on chassis frame (OM 470/471/473 only)

! Do not bleed the fuel system with several starting procedures. You could otherwise damage the starter motor.

- ▶ Apply the parking brake.
- ▶ Switch the ignition lock to the drive position.
- ▶ Shift into neutral.
- ▶ Tilt the cab forwards (electrohydraulic (▷ page 374) or mechanical hydraulic (▷ page 373) cab tilt system).
- ▶ Unscrew the fuel tank filler cap.

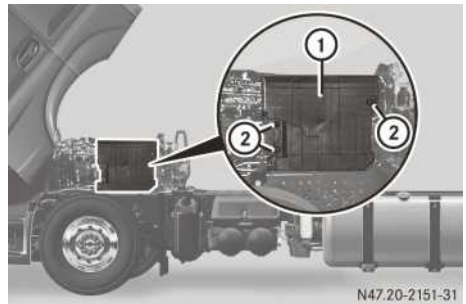

- ▶ Remove bolts ②.
- ▶ Remove cover ①.

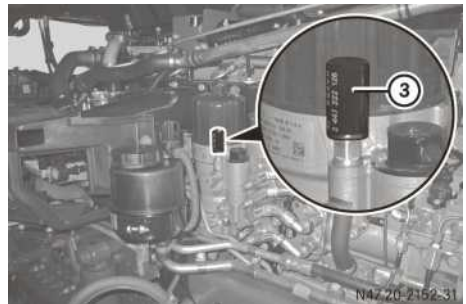

When the fuel pressure has been built up using hand pump ③ on the main filter, you must start the engine within approximately five seconds. Otherwise, the fuel pressure decreases and you will have to repeat the procedure.

- ▶ Press the handle of hand pump ③ on the main filter until there is noticeable resistance.
- ▶ Press the external engine start/engine stop switch (▷ page 376) within approximately five seconds and start the engine.

- ▶ If the engine starts: leave the engine running at an increased engine speed.
- ▶ If the engine does not start: repeat the procedure.
- ▶ Tilt the cab forwards (electrohydraulic (> page 374) or mechanical hydraulic (> page 373) cab tilt system).
- ▶ Tighten the fuel tank filler cap.
- ▶ Mount covering ①.

Bleeding the fuel system without fuel prefilter on chassis frame (OM 936 only)

- ▶ Press and hold the Start/Stop button as far as it will go, or turn the key to the start position in the ignition lock and hold it. Do not depress the accelerator pedal whilst doing so.
- i** The starting procedure is automatically cancelled after approximately 60 seconds.
- ▶ Once the engine starts normally, release the Start/Stop button or the key in the ignition lock and depress the accelerator pedal several times.
The fuel system is completely bled.
- ▶ If the engine does not start, press and hold the Start/Stop button again as far as it will go, or turn the key to the start position in the ignition lock and hold it.

Bleeding the fuel system with fuel prefilter on the chassis frame

Environmental note

Dispose of the water-fuel mixture in an environmentally responsible manner.

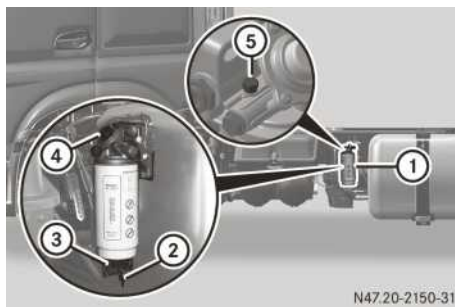

N47.20-2150-31

Fuel prefilter on the chassis frame (example: platform truck)

- ① Fuel prefilter
- ② Drain plug
- ③ Inspection window
- ④ Manual fuel pump
- ⑤ Bleed screw

Bleeding using the hand pump of the fuel prefilter on the chassis frame

- ▶ Unscrew the fuel tank filler cap.
- ▶ Place the collector underneath fuel prefilter ①.
- ▶ Unscrew bleed screw ⑤.
- ▶ Push hand pump ④ repeatedly until the fuel escaping at bleed screw ⑤ is free of bubbles.
- ▶ Tighten bleed screw ⑤.
- i** If there was no fuel in the fuel tank, press hand pump ④ again until there is noticeable resistance.

Vehicles with OM 460/470/471/473: bleed also using the hand pump on the main filter:

- in vehicles with the OM 460 engine (> page 376)
- in vehicles with the OM 470/471/473 engines (> page 377)
- ▶ Tighten the fuel tank filler cap.
- ▶ Press and hold the Start/Stop button as far as it will go, or turn the key to the start position in the ignition lock and hold it. Do not depress the accelerator pedal whilst doing so.
- i** The starting procedure is automatically cancelled:
 - after approximately 60 seconds on vehicles with the OM 936 engine
 - after approximately 40 seconds on vehicles with the OM 470/471/473 engines

In vehicles with the OM 460 engine you must interrupt the starting procedure after

20 seconds and, if necessary, repeat after approximately one minute. After three starting procedures wait for approximately three minutes.

- ▶ Once the engine starts normally, release the Start/Stop button or the key in the ignition lock and depress the accelerator pedal several times.
The fuel system is completely bled.
- ▶ Vehicles with OM 936: if the engine does not start, press and hold the Start/Stop button again as far as it will go, or turn the key to the start position in the ignition lock and hold it.

Air regulation system

Function

Environmental note

If the air regulation system is malfunctioning, fuel consumption may increase.

The air regulation system controls the air supply to the engine radiator. If the slats are open, a high volume of air flows through the engine radiator and the coolant is cooled with maximum efficiency. If the slats are closed, less air flows through the engine radiator and the coolant heats up more quickly.

If the air regulation system is malfunctioning and foreign objects/dirt are not the cause of the issue, you must manually open and lock the affected air regulation system. Open the upper and lower air regulation system and lock them before you drive on. Have the air regulation system repaired as soon as possible at a qualified specialist workshop.

Upper air regulation system

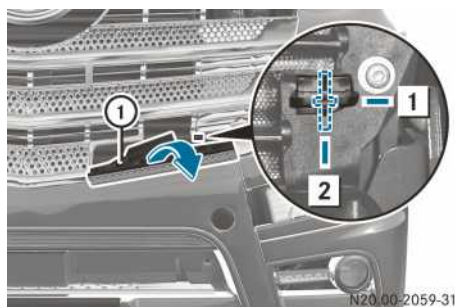

Upper air regulation system (example: Actros)

① Step

1 Released

2 Engaged

- ▶ **To open and lock:** stop the vehicle and apply the parking brake.
- ▶ Switch off the engine.
- ▶ Switch the ignition lock to position **0**.
- ▶ Fold down access step ① beside the left headlamp.
- ▶ To open the slats of the upper air regulation system, carefully fold down one of the middle slats.
- ▶ Turn the lock of the upper air regulation system clockwise to position **2**.

Lower air regulation system

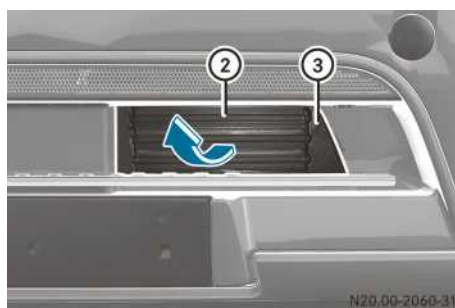

Lower air regulation system (example: Actros, left)

- ▶ **To open and lock:** to open slats ② of the lower air regulation system, carefully fold up one of the middle slats.
 - ▶ Turn locking screw ③ with the Torx key (vehicle tool kit) approximately $\frac{1}{4}$ a turn. The locking lever is unscrewed and locks the lower air regulation system.
- i** The locking screw must be turned a $\frac{1}{4}$ turn on both sides of the lower air regulation system.

Engine does not start

Problem	Possible causes/consequences and ► Solutions
Engine fails to start when the outside temperature is low.	<p>The flow properties of the diesel fuel are inadequate due to paraffin separation.</p> <ul style="list-style-type: none"> ▶ Malfunctions resulting from paraffin separation can be corrected by warming the entire fuel system, e.g. by parking the vehicle in a heated area. ▶ If the engine does not start after another attempt, have the cause traced and rectified at a qualified specialist workshop.
The engine will not start.	<p>The loading tailgate is switched on.  Engine block active appears in the grey event window in the on-board computer.</p> <ul style="list-style-type: none"> ▶ Deactivate the loading tailgate; see the separate operating instructions.
	<p>The engine electronics are malfunctioning.</p> <ul style="list-style-type: none"> ▶ Before attempting the next start, switch the ignition lock unit to position 0.
	<p>The vehicle has been parked up with a gear engaged, e.g. when the reservoir pressure in the transmission/clutch circuit is exhausted as a result of operating the battery isolator switch. For safety reasons, the engine cannot be started when a gear is engaged.</p> <ul style="list-style-type: none"> ▶ Charge the compressed-air system with an external compressed-air source. The transmission control can disengage the clutch again and engage neutral gear. ▶ Start the engine again.

Flat tyre

Changing a wheel in the event of a flat tyre

Important safety notes

WARNING

On uphill and downhill slopes, the jack could tip over with the vehicle raised. There is a danger of injury.

Do not change wheels on uphill or downhill gradients. Contact a qualified specialist workshop.

WARNING

If you do not position the jack correctly at the appropriate jacking point of the vehicle, the jack could tip over with the vehicle raised. There is a risk of injury.

Only position the jack at the appropriate jacking point of the vehicle. The base of the jack must be positioned vertically, directly under the jacking point of the vehicle.

 **WARNING**

If you park a vehicle with pneumatic suspension and leave the ignition switched on, the pneumatic suspension remains active. If you then raise the vehicle using the jack, the pneumatic suspension attempts to compensate the vehicle level. The jack could tip over. There is a danger of injury.

Remove the key from the ignition lock before raising the vehicle. This prevents automatic readjustment of the vehicle level.

 **WARNING**

Oiled, greased or damaged wheel nuts or wheel bolt threads can cause the wheel nuts to loosen or be damaged. As a result, you could lose a wheel while driving. There is a risk of an accident.

Never oil or grease the threads. In the event of damage to the threads, contact a qualified specialist workshop immediately. Have the damaged wheel nuts or wheel bolts replaced. Do not drive on.

 **WARNING**

If you remove a wheel that is resting on the wheel bolts under load, it may fall off or tip. There is a risk of injury.

Remove the last three wheel nuts when it is clear that the wheel is being held tension-free on the wheel bolts.

 **WARNING**

Wheel and tyre dimensions as well as the type of tyre can vary between the spare wheel and the wheel to be replaced. When the spare wheel is fitted, driving characteristics may be severely affected. There is a risk of an accident.

To prevent risks:

- you should therefore adapt your driving style and drive carefully.
- never fit more than one spare wheel that differs from the wheel to be replaced.
- only use a spare wheel that differs from the wheel to be replaced for a short time.
- have a spare wheel that differs from the wheel that has been changed replaced at the nearest qualified specialist workshop. You must observe the correct wheel and tyre dimensions as well as the wheel type.

 **Warning**

When, in the case of twin tyres, you are changing the outer wheel and you drive onto an underlay with the inner wheel, the inner wheel is then under load. In this case, the wheel cannot be correctly pressed up against the contact surface and tightened.

As a result, you could lose a wheel while driving. There is a risk of an accident.

When changing a wheel, always use the jack.

 Do not raise vehicles equipped with a loading crane or loading tailgate by using the hydraulic supports. This would cause damage to the chassis.

When changing a wheel:

- only use wheel nuts that are approved for your vehicle
- note that the wheel nuts for steel and light-alloy wheels differ
- note that the wheel nuts for light-alloy wheels on the front and rear axles differ
- note that wheels with a tyre pressure sensor have a red ring on the tyre valve

Observe the following notes when using the jack to raise the vehicle:

- the maximum jack payload can be found on the sticker attached to the jack.
Before raising the vehicle, make sure that maximum permissible axle load is not exceeded, e.g. by overloading.

The permissible axle load can be found on the vehicle identification plate.

- the jack is designed only to raise the vehicle for a short time, e.g. while a wheel is being changed. It is not suitable for raising and holding the vehicle so that work can be carried out underneath it.
- only position the jack at the appropriate jacking point of the vehicle. Make sure that the jack is correctly positioned on the jacking point before raising the vehicle.

The jacking point may differ on special bodies. Observe the operating instructions issued by the body manufacturer.

- secure the vehicle before raising it to prevent it from rolling away, e.g. by applying the parking brake and/or using chocks. Do not release the parking brake while the vehicle is raised.
- the surface on which the jack is standing must be firm and level. Place the jack on an underlay if the surface is not firm.
- make sure that the gap between the underside of the raised tyre and the ground does not exceed 30 mm. The vehicle could otherwise slip off the jack or tip over.
- do not change a wheel on a slope. The vehicle could otherwise slip off the jack.
- do not place your hands or feet under the raised vehicle.
- do not lie under the raised vehicle.
- make sure that nobody is in the vehicle when it is raised.
- do not start the engine and avoid jolting or shaking the vehicle while it is raised. The vehicle could otherwise slip off the jack.

- ▶ Park the vehicle on a firm and level surface.
- ▶ Apply the parking brake.
- ▶ Use chocks to safeguard the vehicle against rolling away.

Information on tyre pressure can be found in the "Wheels and tyres" section (▷ page 405).

Spare wheel

! Always use spacers to secure wheels of the following sizes to the spare wheel bracket:

- 355/50 R 22.5
- 365/50 R 22.5
- 375/50 R 22.5

- 385/55 R 22.5
- 385/65 R 22.5

You could otherwise damage the wheel or the spare wheel bracket.

Before fitting the wheel to the spare wheel bracket, guide the retaining plate with the fastening bolts through the centre of the wheel rim. From the other side of the wheel, screw the spacer (from the vehicle tool kit) to the fastening bolts.



Spacer

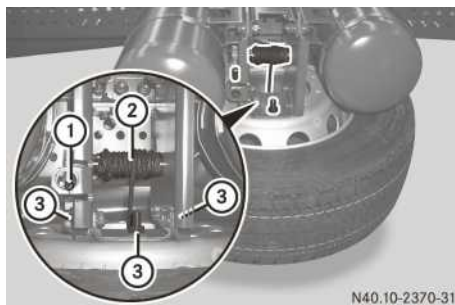

Spare wheel (on the side of the chassis)

Clean rust and dirt off nuts ③ and bolts regularly. Spray nuts ③ and fastening bolts regularly with rust-penetrating oil.

Removing the spare wheel

- ▶ If necessary, remove the side panel or side underride guard.
- ▶ Assemble the hand crank and the pump lever (vehicle tool kit) (▷ page 371).
- ▶ Fit the pump lever and the hand crank on spare wheel hoist ①. Make sure that the retaining sleeve on spare wheel hoist ① engages in the recesses on the pump lever.
- ▶ Turn spare wheel hoist ① until cable ② is taut.
- ▶ Unscrew nuts ③.

- ▶ Lower the spare wheel using spare wheel hoist ①, completely unwinding cable ②.
- ▶ Pull the spare wheel out to the side or to the rear.
- ▶ Unscrew the spare wheel from the spare wheel bracket.
- ▶ Remove the retaining plate through the centre hole of the wheel rim.

Positioning the jack

Steel-sprung front axle



- ▶ Flat tyre on the left-hand side of the vehicle: turn the steering wheel to the left as far as it will go.
- or
- ▶ Flat tyre on the right-hand side of the vehicle: turn the steering wheel to the right as far as it will go.
 - ▶ Position the jack under the jack mounting point beneath the spring mounting directly in front of the front axle.

Air-sprung front axle

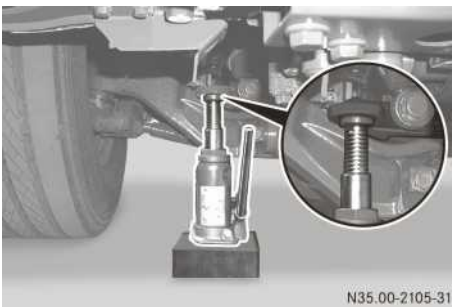

- ▶ Flat tyre on the left-hand side of the vehicle: turn the steering wheel to the left as far as it will go.
- or
- ▶ Flat tyre on the right-hand side of the vehicle: turn the steering wheel to the right as far as it will go.
 - ▶ Position the jack beneath the jacking point on the air suspension support directly in front of the front axle.

All-wheel-drive front axle



- ▶ Flat tyre on the left-hand side of the vehicle: turn the steering wheel to the left as far as it will go.
- or
- ▶ Flat tyre on the right-hand side of the vehicle: turn the steering wheel to the right as far as it will go.
 - ▶ Position the jack under the jacking point beneath the front axle.

Steel-sprung rear axle



Example: steel-sprung rear axle

- ▶ Position the jack under the jack mounting point on the axle tube.

Air-sprung rear axle

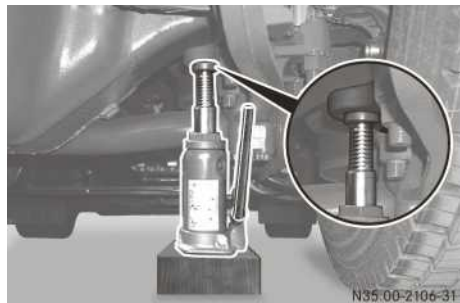

- ▶ Position jack under the jacking point on the air suspension support.

Air-sprung leading axle



Example: air-sprung leading axle

- ▶ Position the jack under the axle tube, between the fastening brackets.

Air-sprung trailing axle



Example: air-sprung trailing axle

- ▶ Position jack under the jacking point on the air suspension support.

Steered trailing axle

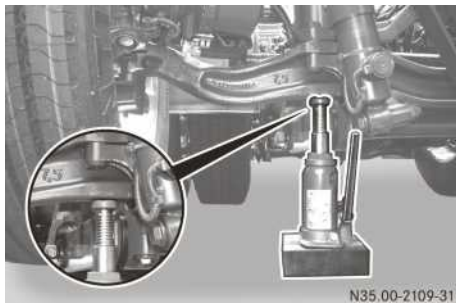

Example: steered trailing axle

- ▶ Position the jack so that the jack plunger is centrally located under the axle carrier.

Removing a wheel



Wheel nut caps

- 1 To loosen
- 2 To tighten

- ▶ Using the wheel nut wrench, loosen 1 the wheel nut caps and remove them.



- ▶ Unscrew the wheel nuts that secure wheel nut cover 1.
- ▶ Remove wheel nut cover 1.

- ▶ Unscrew the remaining wheel nuts.
- ▶ Remove the wheel.
- ▶ Vehicles with 14.00 R 20 twin tyres: remove the wheel nuts for the inner wheel from the connecting flange and then remove the connecting flange.
- ▶ Vehicles with 14.00 R 20 twin tyres: remove the inner wheel.

Fitting a wheel

! After changing a wheel, check the tyre pressure immediately.

Observe the notes on operating and road safety.

! Do not tighten the wheel nuts with an impact wrench. This could damage the wheel nuts or wheel bolts.

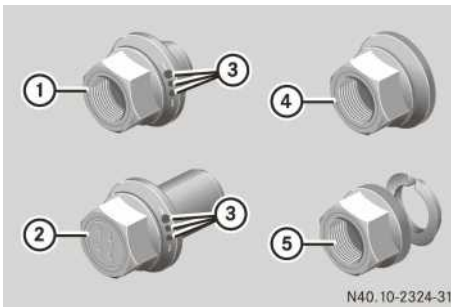

Wheel nuts

- ① For single tyres with light-alloy wheels
- ② For twin tyres with light-alloy wheels
- ③ Wheel nut identification for light-alloy wheels
- ④ With pressure plate (hub centring) for steel wheels
- ⑤ With spherical spring washer for steel wheels

Before fitting a wheel

- ▶ Remove any corrosion and dirt from the contact areas of the wheel hub, rim and wheel nuts.
- ▶ Lightly oil the friction contact surfaces between the pressure plate and the wheel nut.

Fitting a steel wheel

- ▶ Single tyres: fit the wheel in place and screw on 2 to 3 wheel nuts.
- ▶ Single tyres: screw on the remaining wheel nuts together with the wheel nut cover.
- ▶ Twin tyres: fit both the wheels and screw on all remaining wheel nuts.
- ▶ Tighten the wheel nuts in a crosswise pattern, observing the tightening torque while doing so (▷ page 428).
- ▶ Fit the wheel nut caps, observing the tightening torque while doing so (▷ page 428).
- ▶ Check the tyre pressure (▷ page 405).
- ▶ The wheel nuts must be retightened after 50 km (▷ page 386).



Assembly sleeve for twin tyres (vehicles with light-alloy wheels)

Fitting a light-alloy wheel

- ▶ Single tyres: fit the wheel in place and screw on 2 to 3 wheel nuts.
- ▶ Single tyres: screw on the remaining wheel nuts together with the wheel nut cover.
- ▶ Twin tyres: place the assembly sleeve (vehicle tool kit) on the wheel bolt before fitting the inner wheel.
- ▶ Twin tyres: fit both the wheels and screw on 2 to 3 wheel nuts.
- ▶ Twin tyres: remove the assembly sleeve.
- ▶ Twin tyres: screw on the remaining wheel nuts.
- ▶ Tighten the wheel nuts in a crosswise pattern, observing the tightening torque while doing so (▷ page 428).
- ▶ Fit the wheel nut caps, observing the tightening torque while doing so (▷ page 428).
- ▶ Check the tyre pressure (▷ page 405).
- ▶ The wheel nuts must be retightened after 50 km (▷ page 386).

Fitting twin tyres 14.00 R 20

- ▶ Before fitting the inner tyre, check that all of the spherical spring washers are seated properly on the wheel bolts. The round side of the spherical spring washers must face the outside.
- ▶ Fit the inner wheel.
- ▶ Check the wheel centring. The wheel bolts must be located in the centres of the holes in the rims.
- ▶ Fit the connecting flange in place and screw on two to three wheel nuts with spherical spring washers.
- ▶ Check that the flange is properly centred. The wheel bolts must be in the centre of the holes in the connecting flange.
- ▶ Screw on the remaining wheel nuts with spherical spring washers.
- ▶ Tighten the wheel nuts in a crosswise pattern, observing the tightening torque while doing so (▷ page 428).
- ▶ Fit the outside wheel in place and screw on 2 to 3 wheel nuts with spherical spring washers.
- ▶ Check the wheel centring. The wheel bolts must be located in the centres of the holes in the rims.
- ▶ Screw on the remaining wheel nuts with spherical spring washers.
- ▶ Tighten the wheel nuts in a crosswise pattern, observing the tightening torque while doing so.
- ▶ Check the tyre pressure (▷ page 405).
- ▶ Retighten the wheel nuts on the inner wheel after 50 km, as well as the wheel nuts of the outer wheel after a further 50 km (▷ page 386).

Retightening the wheel nuts

WARNING

The wheels could work loose if the wheel nuts and bolts are not tightened to the specified tightening torque. There is a risk of accident. Have the tightening torque immediately checked at a qualified specialist workshop after a wheel is changed.

- ❗ Check wheel nuts regularly for tightness. Retighten if necessary. Replace damaged

wheel nut cover caps and wheel nut covers. Observe the wheel nut tightening torque.

Always observe the instructions and safety notes on "Changing a wheel in the event of a flat tyre" (▷ page 380).

Observe the wheel nut tightening torques (▷ page 428).

Retighten the wheel nuts after 50 km.

When using new or newly painted wheel rims, check the tightening torque of the wheel nuts again after travelling approximately 1,000 to 5,000 km.

- ▶ Retighten the wheel nuts in a crosswise pattern.

On light-alloy wheels, the wheel nuts are not flush with the wheel bolts when tightened.

Electrical fuses

Important safety notes

WARNING

If you manipulate, bridge or replace a faulty fuse with a fuse of a higher amperage, the electric cables could be overloaded. This may result in a fire. There is a risk of an accident and injury.

Always replace faulty fuses with specified new fuses of the correct amperage.

The individual electrical circuits are protected by safety fuses or automatic circuit-breakers. Blown fuses or defective automatic circuit-breakers must be replaced with equivalent fuses with the fuse ratings recommended in the fuse allocation chart. Fuses with the same fuse rating are the same colour.

You can obtain further information from any Mercedes-Benz Service Centre.

The fuse allocation chart is on the inside of the main fuse carrier cover.

If the new fuse which has been inserted also blows, have the cause traced and rectified at a qualified specialist workshop.

- ▶ If a circuit fails, switch off the consumer and turn the ignition back to position 0.

Removing the main fuse carrier cover

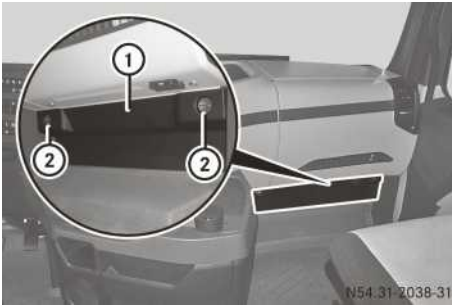

► Open fasteners ② and remove cover ①.

Layout of the fuses

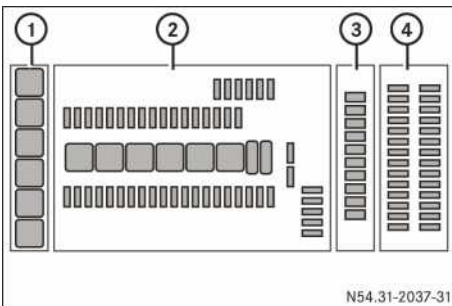

Main fuse carrier

- ① Relays in module A32
- ② Fuses, relays and diodes in the base module (GM)
- ③ Relays in module A31
- ④ Fuses in modules A1 and A2









Fuses in A1 modules:

		Consumer	
F1		Cab tilting pump	5 A
F2		Loading tailgate	10 A
F3		Rotating beacon	10 A
F4		Working-area lamp	10 A
		Exchange dropside body	10 A











		Consumer	
F5		Illuminated Mercedes star	10 A
		Torch socket	10 A
F6		Non-MB body electrical system	15 A
F7		Windscreen heating	25 A
F8		Windscreen heating	25 A
F9		Transfer case oil cooler	10 A
		Hydraulic additional drive system (HAD)	10 A
F10		Fuel prefilter heater with water separator	15 A
F11		Electrical auxiliary air conditioning	20 A
F12		Hydraulic additional drive system (HAD)	15 A
F13		Unassigned	
F14		Unassigned	





















Fuses in A2 modules:









































		Consumer	
F1		MEILLER basic wiring	10 A
F2		Electrics for non-MB body 2 and 3	20 A
		Switch for additional axle for body	20 A
F3		Steered additional axle	10 A
F4		Auxiliary headlamps	15 A
F5		Air regulation system	10 A
F6		Subwoofer	10 A



















		Consumer	
F7		ADR for England	5 A
F8		Interior lighting for low roof	5 A
F9		CB radio	5 A
F10		Radio/navigation	15 A
F11		Electrical auxiliary air conditioning	5 A
		Aerial amplifier	5 A
		Sideguard Assist	5 A
F12		Radio 12 V	10 A
F13		Unassigned	
F14		Unassigned	



Fuses in base module (GM) for SCA:

		Consumer	
F1		Brake system (terminal 30.1)	20 A
F2		Control unit on the driver's door	20 A
F3		Control unit on the co-driver's door	20 A
F4		Drive control	20 A
		Tachograph (terminal 30)	20 A
F5		Programmable special module	15 A
		Distribution (terminal 30)	15 A
F6		Blower	25 A
		Electrical auxiliary air conditioning	25 A
F7		Radio/navigation	25 A















		Consumer	
		12 V voltage transformer	25 A
		Distribution (terminal 30)	25 A
F8		Coolbox	20 A
		Auxiliary heating	20 A
		12 V voltage transformer	20 A
		Adaptive route calculator control unit (terminal 30)	20 A
		LSVA	20 A
F9		Diagnostics connection	10 A
F10		Heating	10 A
		Distance sensor	10 A
		Diver assistance system (terminal 30)	10 A
F11		Toll Collect	10 A
		Rear wall stowage compartment lamp	10 A
		Reading lamp	10 A
		Telephone	10 A
		Tyre pressure monitor	10 A
		Fleet management system (terminal 30)	10 A
		ERA-GLONASS	10 A
F12		Sliding sunroof	15 A
		ATA (Anti-Theft Alarm system)	15 A





















		Consumer	
		LSVA	15 A
		Steering angle sensor	15 A
F13		Level control	25 A
		Hydrodynamic clutch (turbo retarder clutch)	25 A
		Retarder	25 A
F14		Body manufacturer (terminal 30)	10 A
F15		Trailer	20 A
		Trailer voltage transformer (terminal 30)	20 A
F16		Trailer ABS (terminal 30)	20 A
F17		Ignition lock	5 A
		Central gateway	5 A
F18		Modular switch field	5 A
		Remote output voltage transformer	5 A
		Instrument cluster (terminal 30)	5 A
F19		Cigarette lighter	5 A
		Socket (terminal 15)	15 A
F20		Seat heating	20 A
		Distribution (terminal 15)	20 A
F21		Fuel prefilter heater with water separator	15 A
		Distribution (terminal D+)	15 A
F22		Body manufacturer (terminal D+)	10 A
		Fuel prefilter heater with water separator	10 A
F23		BlueTec® exhaust gas aftertreatment	5 A
		Roller sunblind	5 A
		Trailer coupling (low-coupling system)	5 A
		Toll Collect	5 A
		MEILLER basic wiring	5 A
		Hydraulic additional drive system (HAD) (terminal 15)	5 A
		ERA-GLONASS	5 A
F24		Instrument cluster	5 A
		Battery isolator switch	5 A
		Tachograph	5 A
		Brake system	5 A
		Airbag	5 A
		Telephone	5 A
		Transmission control	5 A
		Fleet management system	5 A
		Auxiliary headlamps	5 A
F25		Trailer ABS	10 A
F26		Drive control	10 A

















		Consumer	
		Programmable special module (terminal 15)	10 A
F27		Engine management (terminal 15)	10 A
		Reversing camera	10 A
		Driver assistance system	10 A
		Adaptive route calculator control unit (terminal 15)	10 A
F28		Retarder	10 A
		Hydrodynamic clutch (turbo retarder clutch)	10 A
		Electronic air processing unit (terminal 15)	10 A
F29		Transmission control (terminal 30.1)	15 A
		CB radio	15 A
F30		Brake system (terminal 30.2)	20 A
F31		Trailer brake lamp	15 A
F32		24 V power sockets	25 A
		24 V additional socket	25 A
F33		Roof stowage compartment lamp	10 A
		Remote output voltage transformer	10 A
F34		24 V power socket	25 A
		12 V voltage transformer	25 A
		Non-MB body electrical system	15 A



















		Consumer	
F35		Unassigned	
F36		Electronic air processing unit (terminal 30)	20 A
F37		Transmission control (terminal 30.2)	15 A











Fuses in base module (GM) for SSAM:

		Consumer	
F1		Brake system (terminal 30.1)	20 A
F2		Diagnostics connection	10 A
F3		Auxiliary heating	15 A
		Adaptive route calculator control unit	15 A
		12 V voltage transformer	15 A
F4		Toll Collect	10 A
		Steer angle sensor	10 A
		Telephone	10 A
		Fleet management system	10 A
		Tyre pressure monitor	10 A
		Rear stowage compartment lamp (terminal 30)	10 A
		ERA-GLONASS	10 A
F5		LSVA	15 A
		Sliding sunroof	15 A
		ATA (Anti-Theft Alarm system)	15 A







		Consumer	
		CB radio	15 A
F6		Heating	10 A
		Driver assistance system	10 A
		Reading lamp (terminal 30)	10 A
		Distance sensor	10 A
F7		Electronic air processing unit (terminal 30)	20 A
F8		Level control	25 A
		Retarder	25 A
F9		Body manufacturer (terminal 15)	10 A
		Toll Collect	10 A
		BlueTec® exhaust gas aftertreatment	10 A
		ERA-GLONASS	10 A
F10		Trailer brake lamp	20 A
		Body manufacturer brake lamp	20 A
F11		Programmable special module	20 A
		Coolbox (terminal 30)	20 A
F12		Drive control	20 A
		Tachograph (terminal 30)	20 A
F13		12 V voltage transformer	25 A
		Radio/navigation (terminal 30)	25 A







		Consumer	
		Hydrodynamic clutch (turbo retarder clutch)	25 A
F14		Body manufacturer (terminal 30)	10 A
F15		Transmission control (terminal 30.1)	15 A
F16		Trailer ABS	10 A
F17		Unassigned	
F18		Seat heating	15 A
F19		Unassigned	
F20		24 V power socket	25 A
		Non-MB body electrical system	15 A
		CB radio	15 A
F21		Fuel prefilter heater with water separator	15 A
		Distribution (terminal D+)	15 A
F22		Body manufacturer (terminal D+)	10 A
		Fuel prefilter heater with water separator	10 A
F23		Unassigned	
F24		Unassigned	
F25		Trailer ABS	20 A
F26		Trailer	20 A
		Trailer voltage transformer (terminal 30)	20 A
F27		Control unit on the driver's door	20 A
F28		Unassigned	
F29		Control unit on the co-driver's door	20 A

		Consumer	
F30		Unassigned	
F31		Unassigned	
F32		Roof storage compartment lamp	10 A
		Remote output voltage transformer	
F33		24 V power sockets	25 A
		24 V additional socket	25 A
F34		Unassigned	
F35		Blower	25 A
F36		Hydraulic additional drive system (HAD)	5 A
		MEILLER basic wiring	5 A
		Tachograph	5 A
		Instrument cluster	5 A
		Brake system	5 A
		Auxiliary headlamps	5 A
		Airbag	5 A
		LSVA	5 A
		Adaptive route calculator control unit	5 A
		Telephone	5 A
		Fleet management system	5 A
		Transmission control	5 A
		Battery isolation switch (terminal 15)	5 A
F37		Brake system (terminal 30.2)	20 A



		Consumer	
F38		Driver assistance system	10 A
		Reversing camera	10 A
		Engine management (terminal 15)	10 A
		Exchange dropside body (terminal 15)	10 A
F39		Transmission control (terminal 30.2)	15 A
F40		Drive control	10 A
		Programmable special module (terminal 15)	10 A
F41		Retarder	10 A
		Electronic air processing unit (terminal 15)	10 A
F42		Cigarette lighter	5 A
		Socket	15 A

Relays in module A31:







		Consumer
K1		Working-area lamp
		Exchange dropside body
K2		Transfer case oil cooler
K3		Fuel prefilter heater with water separator
K4		Loading tailgate
		Hydraulic additional drive system (HAD) shutoff
K5		Loading tailgate



		Consumer
		Hydraulic additional drive system (HAD) shutoff
K6		Radio 12 V (terminal 58)
K7		Radio 12 V (terminal 15R)
		Subwoofer
K8		Auxiliary headlamps (terminal 58)
K9		Interior lighting for low roof
K10		Interior lighting for low roof

Relays in module A32:









		Consumer
K1		Windscreen heating
K2		Windscreen heating
K3		Auxiliary headlamp (terminal 56a)
K4		Unassigned
K5		Unassigned
K6		Unassigned

Relay in base module (GM) for SCA:



		Consumer
K1		Amplifier (terminal 15)
K2		Amplifier (terminal D+)
K3		Amplifier (terminal 15)
K4		Transmission oil cooling
K5		Amplifier (terminal 15)
K6		Trailer brake lamp

		Consumer
K7		Bi-stable relay
K8		Bi-stable relay
K9		Unassigned

Relays in base module (GM) for SSAM:

		Consumer
K1		Unassigned
K2		Amplifier (terminal D+)
K3		Transmission oil cooling
K4		Amplifier (terminal 15)
K5		Amplifier (terminal 15)
K6		Trailer brake lamp
K7		Amplifier (terminal 15)
K8		Bi-stable relay
K9		Bi-stable relay

Diodes in base module (GM):

		Consumer
D1		Loading tailgate
D2		Horn (air horn)
D3		Unassigned
D4		Unassigned
D5		Unassigned

Checking and replacing a safety fuse

- ▶ Pull the fuse out of the module using the pliers and carry out a visual inspection.
- ▶ If the fuse wire has melted, replace the blown fuse with a spare fuse.
- ▶ Switch on consumers and check that they function correctly.

If the safety fuse blows again, have the electrical system checked at a qualified specialist workshop.

Checking and switching on an automatic circuit-breaker

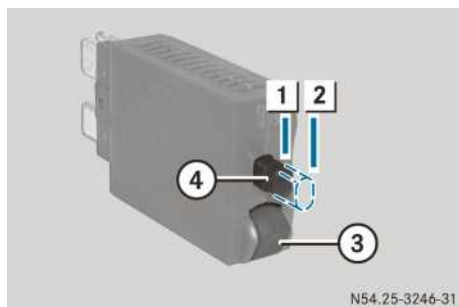

Automatic circuit-breaker

If an automatic circuit-breaker is tripped, pin ④ moves to OFF position ②.

- ▶ Pull the automatic circuit-breaker out of the module.
- ▶ Press pin ④ into ON position ①.
- ▶ Press trip switch ③.
- If pin ④ moves to OFF position ②, the automatic circuit-breaker is functioning correctly.
- If pin ④ does not move to OFF position ②, replace the automatic circuit-breaker.
- ▶ Press pin ④ into ON position ① and refit the circuit-breaker.
- ▶ Switch on consumers and check that they function correctly.

If the automatic circuit-breaker is tripped again, have the electrical system checked at a qualified specialist workshop.

Charging the compressed-air system

- ❗ If the supply pressure of the external compressed-air source is under 11 bar it cannot be guaranteed that you will be able to fill all the pressure circuits.

Bear in mind that the compressed air does not pass through the compressed-air drier if you fill the compressed-air system via:

- connection 28 on the electronic air processing unit
- the connections on the brake power sensor beneath the maintenance flap

For this reason, the air from the external compressed-air source must be clean and dry.

Fill the pressure circuits up to a maximum pressure of 12.5 bar. Otherwise, compressed-air system components could be damaged.



Filler connections on the brake power sensor

When the engine is not running, fill the compressed-air system via filler connections ① at the front of the brake power sensor. This does not fill the pressure circuit of the air suspension.

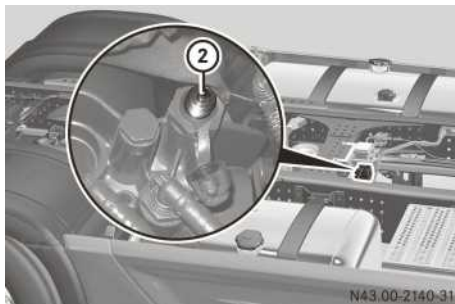

Example: connection 28 on the electronic air processing unit

If you fill the compressed-air system via connection 28 ② on the electronic air processing unit, the pressure circuit of the air suspension is also filled.

i The electronic air processing unit contains the following components in one unit:

- pressure regulator
- compressed-air dryer
- multiple-circuit safety valve
- pressure limiting valve
- control unit

Before towing, check that the spring-loaded cylinders of the parking brake are released. If the compressed-air supply is insufficient, release the spring-loaded cylinders manually (▷ page 400).

Jump-starting, tow-starting and towing away

Jump-starting

Important safety notes

WARNING

Battery acid is caustic. There is a risk of injury. Avoid contact with skin, eyes or clothing. Do not inhale any gases released from the battery. When carrying out maintenance work on the battery, wear acid-resistant protective clothing, particularly protective eyewear, protective gloves and an apron. Do not lean over the battery. Keep the batteries out of the reach of children.

If you come into contact with battery acid, observe the following:

- immediately rinse battery acid off skin thoroughly with clean water and seek immediate medical attention.
- if you get battery acid in your eyes, rinse them thoroughly with clean water immediately. Consult a doctor without delay.

WARNING

During charging and jump-starting, explosive gases can escape from the battery. There is a risk of an explosion.

Particularly avoid fire, naked flames, creating sparks and smoking. Ensure there is sufficient ventilation while charging and jump-starting. Do not lean over a battery.

! Observe the following notes. You could otherwise damage the battery or electronic components in the vehicle:

- do not use a battery quick-charge unit for jump-starting.
- if you use a mobile battery charger (battery device with mains power stage), remove the mains plug before jump-starting.
- only have jump-starting provided by vehicles with a 24 V system.
- use jump leads which are protected against polarity reversal and with a wire cross section of approximately 35–50 mm² and insulated terminal clamps.
- if the outside temperature drops below -10 °C, a discharged battery could freeze. Do not start the engine under these circumstances. Let the battery thaw out first.

! Do not connect the negative terminal clamp of the jump lead to the chassis frame. Otherwise, engine or transmission components can be damaged.

! When you remove the jump leads, let the engine of the vehicle being jump-started idle. This avoids damage being caused to the vehicle electronics.

General notes

Observe the safety notes and protective measures when handling the battery (▷ page 362). After jump-starting, have the batteries checked at a qualified specialist workshop.

- ▶ Make sure that the vehicles are not touching.
- ▶ Apply the parking brake.
- ▶ Switch off all electrical consumers.
- ▶ Switch the ignition lock to position 0.

Vehicles without a jump-starting connection point

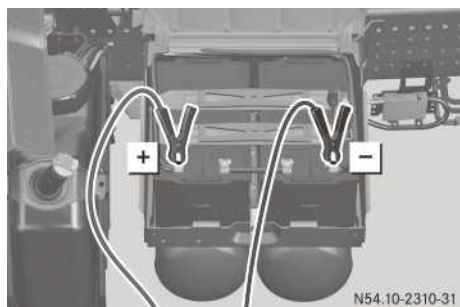

Vehicles without a jump-starting connection point (example: platform truck)

Connecting the jump lead

- ▶ Remove the battery compartment cover (> page 363).
- ▶ First, connect the positive terminal clamp of the jump lead to the positive terminal of the other vehicle's battery and then to the **+** positive terminal of the starter battery.
- ▶ First, connect the negative terminal clamp of the jump lead to the negative terminal of the other vehicle's battery and then to the **-** negative terminal of the starter battery.
- ▶ Assisting vehicle: run the engine at a high speed.
- ▶ Start the engine and leave it running at idling speed.

Disconnecting the jump lead

- ▶ First, disconnect the negative terminal clamps of the jump lead from the negative terminals.
- ▶ Remove the positive terminal clamps of the jump lead from the positive terminals.

Vehicles with a jump-starting connection point

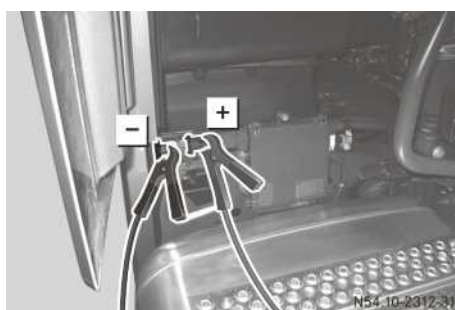
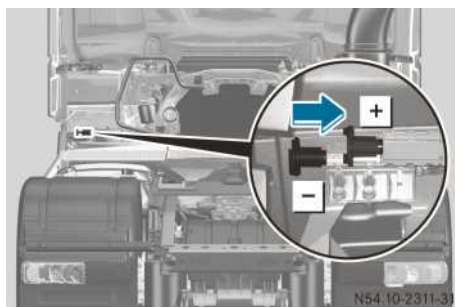

Vehicles with a jump-starting connection point (example: tractor/semitrailer combination)

Connecting the jump lead

- ▶ First, connect the positive terminal clamp of the jump lead to the positive terminal of the other vehicle's battery.
- ▶ Slide back the red protective cap with the other positive terminal clamp of the jump lead and connect the positive terminal clamp to the **+** positive terminal.
- ▶ First, connect the negative terminal clamp of the jump lead to the negative terminal of the other vehicle's battery.
- ▶ Slide back the black protective cap with the other negative terminal clamp of the jump lead and connect the negative terminal clamp to the **-** negative terminal.
- ▶ Assisting vehicle: run the engine at a high speed.
- ▶ Start the engine and leave it running at idling speed.

Disconnecting the jump lead

- ▶ First, disconnect the negative terminal clamps of the jump lead from the negative terminals.
The black protective cap of the jump-start connection point springs back into its original position.
- ▶ Remove the positive terminal clamps of the jump lead from the positive terminals.
The red protective cap of the jump-start connection point springs back into its original position.

Notes on tow-starting and towing away

Specialist knowledge beyond the scope of these Operating Instructions is required for tow-starting and towing the vehicle away. Only have your vehicle towed away or tow-started by a professional towing/recovery company.

Only in exceptional cases, e.g. when leaving areas of danger, should the vehicle be towed with the propeller shaft installed.

Vehicles with power steering: only tow-start the vehicle if the ignition is switched on and the red  warning lamp is not lit in the instrument cluster. Tow-start the vehicle on a straight stretch of road. Only tow the vehicle with raised front axles.

- ▶ Observe the general notes on towing away, except the information on removal of the propeller shaft.
- ▶ Activate backup drive mode and towing mode (▷ page 140).

i Information on towing away and recovery can be found on the Internet at: <https://xentryportal.i.daimler.com/wps/portal/>

You can obtain further information from any Mercedes-Benz Service Centre.

Manoeuvring/tow-starting and towing away

Important safety notes

WARNING

If the distance control assistant is switched on, the vehicle accelerates or brakes auto-

matically in certain situations. If you use the vehicle as working machinery with distance control assistant switched on, the vehicle may accelerate or brake unexpectedly. There is a risk of an accident.

Always switch off the distance control assistant in this or similar situations.

WARNING

If Active Brake Assist is activated while you are towing your vehicle or using it, e.g. as working machinery, the vehicle may brake automatically. The wheels could lose grip. There is a risk of an accident.

Always deactivate Active Brake Assist in this or similar situations.

WARNING

If the engine is not running, the hydraulic power steering and the compressed-air supply are inoperative. To steer, you will require considerably more force. The spring-loaded parking brake can activate if there is a loss of compressed air and the vehicle may then brake uncontrollably. You could therefore lose control of the vehicle. There is a risk of an accident.

Always use a tow bar. Always ensure the compressed-air supply using an external compressed-air source.

! Attachments and bodies can affect the vehicle height and width. Do not exceed the permissible vehicle height and observe the legal requirements for the country you are currently in.

If the rear of the vehicle is raised for towing away, fold back the wind deflectors.

Drive carefully and anticipate road and traffic conditions. Observe the maximum clearance of underpasses.

! When towing/tow-starting, please observe the following:

- If the engine is not running, have the propeller or drive shaft removed. Otherwise, the transmission may be damaged.
- If the engine is not running and the spring-loaded parking brake is activated as a

result of a loss of compressed air, the brakes may overheat and be damaged. Charge the compressed-air system or disengage the spring-loaded parking brake manually.

- For vehicles with air suspension, check the driving level during towing/tow-starting and correct it if necessary. Otherwise, parts of the vehicle or the air suspension could be damaged.
- Before towing, switch off Active Brake Assist. Otherwise, Active Brake Assist could brake the vehicle while it is being towed. This could cause the brakes to overheat and be damaged.

If you transport the vehicle on a low-loader, the permissible vehicle height may be exceeded. Pay attention to the headroom clearance of buildings, e.g. bridges.

Before towing away, agree on a clear signal with the towing vehicle driver. Both you and the towing vehicle driver must adapt the driving style used to the more difficult conditions.

Information on charging the compressed-air system using an external compressed-air source can be found in the "Charging the compressed-air system" section (▷ page 394).

Information on releasing the spring-loaded parking brake can be found in the "Releasing the spring-loaded parking brake" section (▷ page 400).

Coupling jaw

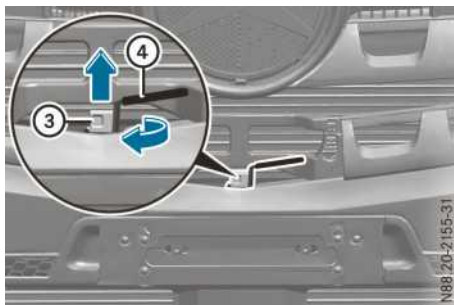
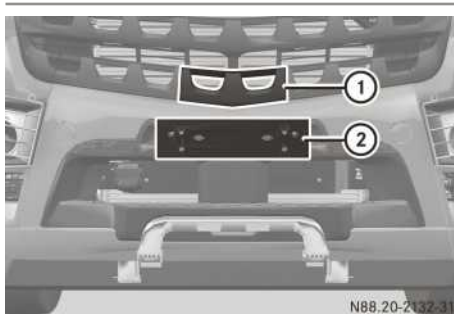

Example: coupling jaw

Use the front coupling jaw for manoeuvring, tow-starting and towing away.

The coupling pin is prevented from rotating (e.g. when towing with a steel rope) by locking spring (3) with a retaining pin (4).

- ▶ Vehicles with a large approach/departure/overhang angle: fold down the collapsible step.
- ▶ Remove coupling pin cover (1) forwards.
- ▶ Grasp licence plate holder (2) at the sides and swing it down.
- ▶ Using a thumb, push locking spring (3) with the retaining pin upwards and, in doing so, release coupling pin (4).
- ▶ Turn coupling pin (4) clockwise by 90° and pull it upwards and out.
- ▶ Attach the towbar.
- ▶ Insert coupling pin (4) downwards through the tow bar eyelet and turn it anti-clockwise by 90° to its original position. The retaining pin engages audibly.
- ▶ Position coupling pin cover (1) and clip it in place.

Front towing eyes

Warning

If you lift the vehicle onto towing eyes that differ from the original towing eyes, they can break. The vehicle could fall out of the bracket while being towed. There is a risk of an accident.

For safety reasons, only use towing eyes for lifting that have been specified and approved for your vehicle.

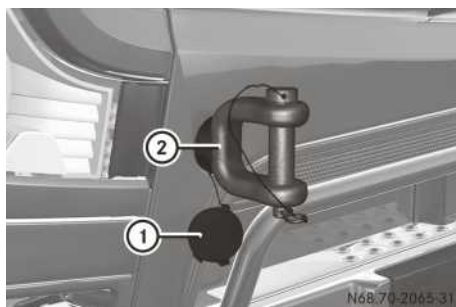
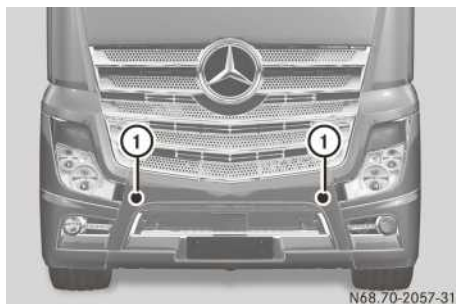

Front towing eye (example: Actros)

If towing eye ② is not included in the vehicle tool kit, you can obtain towing eye ② at any Mercedes-Benz Service Centre.

Press the area marked with an arrow on cover ① in order to open it. Towing eye ② is screwed into the frame head behind cover ①. Make sure that the towing eye is completely screwed in. If the thread is dirty, clean it before screwing the towing eye in.

The towing eyes are made from a special material with higher strength values. Only use the original towing eyes.

You will need a second towing eye in order to lift the vehicle at the front.

The person towing away the vehicle should bring one with them or you can purchase one at a Mercedes-Benz Service Centre.

The vehicle can thus be raised and towed away.

Vehicles with fittings for front attachments: the threaded hole is not suitable for towing eyes. Do not use towing eyes for tow-starting and towing away. Use the front coupling jaw for tow-starting and towing away the vehicle.

Rear towing coupling

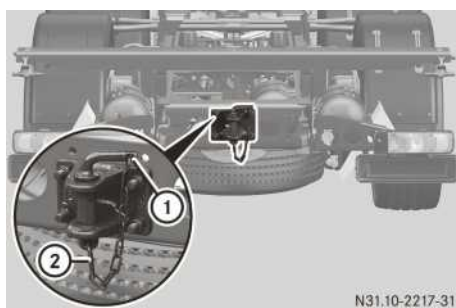

Example: cross member with towing coupling

Use the rear towing coupling for manoeuvring, tow-starting and towing away.

- ▶ Unhook catch ② on coupling pin ①.
- ▶ Remove coupling pin ①.
- ▶ Attach the towbar.
- ▶ Push coupling pin ① down through the eyelet of the towing bar.
- ▶ Hook catch ② onto coupling pin ① again.

Releasing the spring-loaded parking brake

Arrangement of the spring-loaded parking brake cylinders

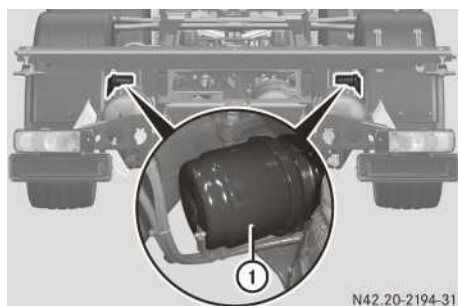

- ① Spring-loaded parking brake cylinder (example: platform truck)

The positioning of the spring-loaded parking brake cylinder on the front and/or rear axle depends on the axle type.

Positioning on the front axle(s)

	1	2
4x2	x ^{5, 6}	—
4x4	x ⁵	—
6x2	—	—
6x2 DNA	x ⁵	—
6x2 /2	x	—
6x2 /4	x	—
6x4	x ^{5, 6}	—
6x6	x ⁵	—
8x4 ENA	x	—
8x4 /4	—	x
8x6 /4	x ⁵	x
8x8 /4	x ⁵	x

Positioning on the rear axle(s)

	1	2
4x2	x	—
4x4	x	—
6x2	x	x
6x2 /2	—	x
6x2 /4	—	x
6x4	x	x
6x6	x	x
8x4 ENA	x	x
8x4 /4	x	x
8x6 /4	x	x
8x8 /4	x	x

Manually releasing the spring-loaded parking brake cylinder

- ⚠ Undo the release bolt with a maximum torque of 70 Nm. Do not use an impact wrench. You could otherwise damage the spring-loaded parking brake cylinder.

⁵ Optional equipment.

⁶ In connection with disc brakes.

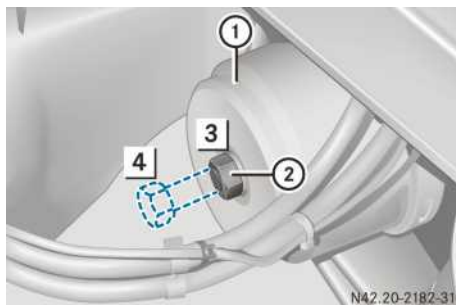

Spring-loaded parking brake cylinder with release screw

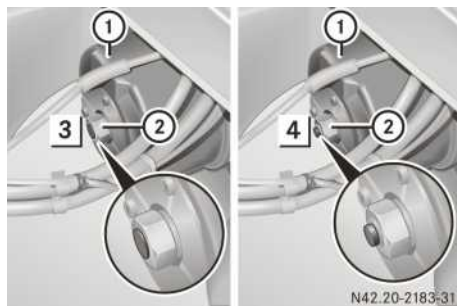

Spring-loaded parking brake cylinder with release screw and release indicator

- ① Spring-loaded parking brake cylinder
- ② Release screw
- ③ Drive position
- ④ Released position

If there is insufficient reservoir pressure to release the parking brake, release the spring-loaded parking brake cylinders mechanically in the event of an emergency.

The vehicles may be fitted with different types of spring-loaded parking brake cylinders depending on the axle, e.g. spring-loaded parking brake cylinders with a release screw or with a release indicator. Release all the spring-loaded parking brake cylinders on the vehicle.

- ▶ Use chocks to safeguard the vehicle against rolling away.
- ▶ Turn release screw ② of spring-loaded parking brake cylinder ① anti-clockwise until the stop in release position ④.

Moving the spring-loaded parking brake cylinder to the driving position

- ! Tighten the release bolt up to a torque of 35 Nm. Do not use an impact wrench. You could otherwise damage the spring-loaded parking brake cylinder.

Reset all spring-loaded parking brake cylinders to the drive position.

- ▶ Charge the brake circuit until the cut-off pressure is reached.
- ▶ Swing the parking brake lever as far as it will go to the released position.
- ▶ Turn release screw ② of spring-loaded parking brake cylinder ① clockwise to driving position ③.
- ▶ Tighten release screw ②.

Useful information

These Operating Instructions describe all the models and standard and optional equipment of your vehicle that were available at the time of going to print. Country-specific differences are possible. Bear in mind that your vehicle may not be equipped with all the functions described. This also applies to safety-relevant systems and functions.

Read the information on qualified specialist workshops (▷ page 31).

Operating and road safety

Regular checking of wheels and tyres

Tyres are of particular importance to the operating and road safety of the vehicle.

Regularly check the following:

- tyre pressure (▷ page 404)
- tyre tread
- tyre condition

A tyre dealer, a qualified specialist workshop or a Mercedes-Benz Service Centre will be able to provide further you with information about the:

- tyre load-bearing capacity (LI, Load Index)
- tyre speed rating
- tyre age
- causes and consequences of tyre wear
- measures to be taken in the event of tyre damage
- types of tyre for specific regions, areas of operation or conditions of vehicle use
- interchangeability of tyres, etc.

Tyre tread

⚠ WARNING

Insufficient tyre tread will reduce tyre traction. The tyre is no longer able to dissipate water. This means that on wet road surfaces, the risk of aquaplaning increases, in particular where speed is not adapted to suit the driving conditions. There is a risk of accident.

If the tyre pressure is too high or too low, tyres may exhibit different levels of wear at differ-

ent locations on the tyre tread. Thus, you should regularly check the tread depth and the condition of the tread across the entire width of all tyres.

Minimum tyre tread depth for:

- summer tyres: 3 mm
- M+S tyres: 4 mm

For safety reasons, replace the tyres before the legally prescribed limit for the minimum tyre tread depth is reached.

⚠ WARNING

There is a danger of aquaplaning occurring, even if you are driving slowly and your tyres have sufficient tread depth, depending on the depth of water on the road. There is a risk of an accident.

For this reason, avoid tyre ruts and brake carefully.

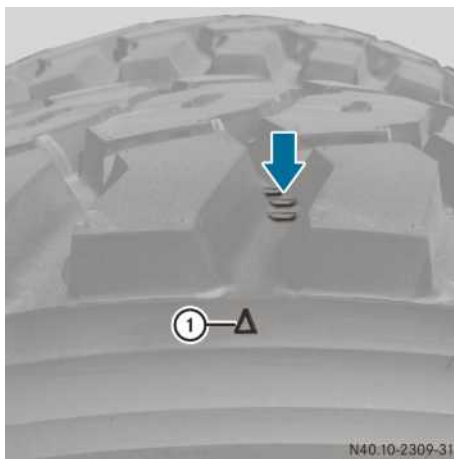

① Example: tyre tread wear indicator

A specified minimum tread depth is a legal requirement for all tyres. Observe the legal requirements for the country you are currently in.

The less tyre tread depth remaining, the poorer the road grip and handling characteristics of the vehicle, particularly if the road surface is wet or snow-covered.

A tyre has reached the minimum tread depth when the tread wear indicator (arrow) is flush with the tyre tread.

For safety reasons, have the tyres replaced before the legally specified minimum tread depth is reached.

Tyre condition

Important safety notes

WARNING

Damaged tyres can cause tyre inflation pressure loss. As a result, you could lose control of your vehicle. There is a risk of accident.

Check the tyres regularly for signs of damage and replace any damaged tyres immediately.

Before starting your journey, check the tyre condition for:

- external damage
- foreign objects in the tyre tread
- foreign objects between the tyres (on vehicles with twin tyres)
- cracks or bulges
- uneven tread wear or excessive wear on one side

Tyre damage

Tyre damage can, for example, be caused by:

- the operating conditions of the vehicle
- tyre ageing
- kerbs
- foreign objects
- insufficient or excessive tyre pressure
- weather conditions and environmental factors
- contact with oil, grease, fuel

Tyre age



Tyres age, even if they are used infrequently or not at all. Operating and road safety diminish with age. For this reason have tyres more than six years old checked and, if necessary, replaced at a qualified specialist workshop. This also applies to the spare wheel.

Date of manufacture ① informs you about the age of a tyre. The first and second digits refer to the week of manufacture, starting with "01" for the first calendar week of the year. The third and fourth digits refer to the year of manufacture. A tyre that is marked "3808", for example, was thus manufactured in the 38th calendar week of 2008.

Tyre load-bearing capacity, tyre speed rating and tyre types

WARNING

Exceeding the stated tyre load-bearing capacity and the approved maximum speed could lead to tyre damage or the tyre bursting. There is a risk of accident.

Therefore, only use tyre types and sizes approved for your vehicle model. Observe the tyre load rating and speed rating required for your vehicle.

In particular, observe the permissible tyre specifications for the country you are currently in. These requirements may stipulate a specific tyre type for your vehicle. In addition, the use of specific tyre types may be advisable for certain regions and areas of operation.

A tyre dealer, a qualified specialist workshop or a Mercedes-Benz Service Centre will be able to

provide you with further information about the tyres.

Replacing the tyres and retreaded tyres

Replacing tyres

If replacing the standard tyres of your vehicle, use only the tyre and wheel rim sizes approved for your vehicle type.

A tyre dealer, a qualified specialist workshop or a Mercedes-Benz Service Centre will be able to provide you with further information.

After replacing your tyres, carry with you the vehicle's type approval for the new tyre and wheel rim size as well as the manufacturer's certification showing that the tyres may be used on the vehicle. Observe the legal requirements for the country you are currently in.

A Mercedes-Benz Service Centre can provide you with information on obtaining a manufacturer's certificate.

After replacing your tyres, it may be necessary for adjustments to be made to the control unit modules. If necessary, have these adjustments carried out at a qualified specialist workshop.

Vehicles with power steering: if you change the mechanical axle stops, e.g. during tyre replacement, have the power steering taught in at a qualified specialist workshop.

Retreaded tyres

Mercedes-Benz recommends that you only use tyres and wheels which have been tested and approved by Mercedes-Benz specifically for your vehicle.

Balancing tyres

Mercedes-Benz recommends that you only use clip-on and adhesive wheel balance weights which have been tested and approved by Mercedes-Benz specifically for your vehicle to balance the tyres.

Adding balancing granulate, balancing beads or balancing gel to the tyres can damage the inliner of the tyre.

Wheels with a tyre pressure sensor

Mounting

! To balance wheels with tyre pressure sensors, only use balance weights recommended by Mercedes-Benz which can be clipped or glued on. Balancing granulate, balancing beads or balancing gel can damage the tyre pressure sensor and the tyre.

You can recognise wheels with tyre pressure sensors by a red ring on the tyre valve. Observe the mounting instructions and information on the tyre pressure monitor when changing a tyre (▷ page 144).

A tyre dealer, a qualified specialist workshop or a Mercedes-Benz Service Centre will be able to provide you with further information.

Storage

The battery of a tyre pressure sensor for checking the tyre pressure is activated automatically when it is mounted. The tyre pressure sensor will then begin to transmit data periodically.

The longer you store wheels with a tyre pressure sensor mounted, the shorter the service life of the tyre pressure sensor battery during road use. Therefore, tyre pressure monitors should only be mounted a short time before the wheel is used.

Tyre pressures

Important safety notes

WARNING

Underinflated or overinflated tyres pose the following risks:

- the tyres may burst, especially as the load and vehicle speed increase.
- the tyres may wear excessively and/or unevenly, which may greatly impair tyre traction.
- the driving characteristics, as well as steering and braking, may be greatly impaired.

There is a risk of an accident.

Observe the recommended tyre pressure and check the tyre pressure of all the tyres including the spare wheel:

- at least once a month
- when the load changes
- before embarking on a longer journey
- for changed operating conditions, e.g. off-road driving.

If necessary, correct the tyre pressure.

⚠ WARNING

The tyre temperature and pressure increase when the vehicle is in motion. Reducing the pressure of warm tyres leads to a tyre pressure that is too low when the tyres have cooled. If the tyre pressure is too low, it may cause the tyre to burst, especially when the load or speed increases. There is a risk of an accident.

You should never reduce the pressure of warm tyres. Observe the specified tyre pressure.

For every 10 °C change in air temperature, the tyre pressure changes by around 30 to 40 kPa (0.3 to 0.4 bar/4.4 to 5.8 psi). Bear this temperature-related change in tyre pressure in mind when checking tyre pressures indoors, where the temperature may be higher than the outside temperature.

Example:

- room temperature is approximately 20 °C.
- outside temperature is approximately 0 °C.
- set the tyre pressure to around 60 to 80 kPa (0.6 to 0.8 bar/8.7 to 11.6 psi) above that prescribed in the tyre pressure table.

The tyre pressures are specified according to E.T.R.T.O. standards and may deviate from the manufacturer's specifications.

Also observe the general notes in the "Operating and road safety" section (▷ page 402).

Before starting your journey, check the specified tyre pressures while the tyres are cold.

If the tyre pressure is too low, it leads to:

- excessive build-up of heat in the tyres
- increased tyre wear

- altered driving stability
 - increased fuel consumption
- Excessive tyre pressure leads to:

- an increased braking distance
- a deterioration in tyre traction
- increased tyre wear

The valve caps on the tyre valves protect the valve cores from moisture and dirt. Always screw the valve caps tightly onto the tyre valves. In the event of repeated pressure loss in the tyres, external damage or leaking tyre valves may be the cause. Check the condition of the tyres regularly.

Determining tyre pressures

- ❗ Correct the tyre pressures for each axle on the vehicle.



Example: tyre size and load bearing index

- Read off tyre size ① and load bearing index ② on the tyre.

If load bearing index ② is comprised of two numbers, the first number before the "/" is for single tyres and the second number, after the "/", is for twin tyres.

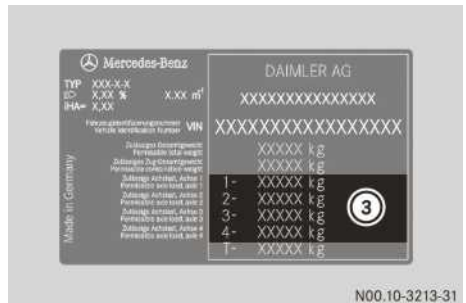

Example: permissible axle load

- ▶ Determine permissible axle load ③ by checking the vehicle identification plate.
- ▶ Select the tyre pressure table which corresponds to the tyre type.
 - Single tyres (▷ page 406)
 - Twin tyres (▷ page 411)
- ▶ Search for tyre size ① in the tyre pressure table.
- ▶ Search for load bearing index ② which corresponds to the tyre type next to the tyre size in the tyre pressure table.
- ▶ Find maximum permissible axle load ③ in the tyre pressure table and read off the tyre pressure.

For specific tasks, e.g. during winter maintenance, a maximum vehicle axle load rating for fitting approved attachments may be increased. In such cases, the speed of the vehicle is limited. The tyre pressure will then deviate from the information in the following tyre pressure table. It needs to be increased in accordance with the E.T.R.T.O. standard and the information provided by the tyre manufacturer.

Tyre pressure table for single tyres

Tyres 215/75 R 17.5

Load bearing index 135

- Axle load 4,300 kg: 850 kPa (8.5 bar/123 psi)

Tyres 12 R 20

Load bearing index 154

- Axle load 6,300 kg: 725 kPa (7.25 bar/105 psi)
- Axle load 6,700 kg: 775 kPa (7.75 bar/112 psi)
- Axle load 7,100 kg: 800 kPa (8.0 bar/116 psi)
- Axle load 7,500 kg: 850 kPa (8.5 bar/123 psi)

Tyres 14 R 20

Load bearing index 160

- Axle load 6,300 kg: 450 kPa (4.50 bar/65 psi)
- Axle load 6,700 kg: 475 kPa (4.75 bar/69 psi)
- Axle load 7,100 kg: 525 kPa (5.25 bar/76 psi)
- Axle load 7,500 kg: 575 kPa (5.75 bar/83 psi)
- Axle load 8,000 kg: 600 kPa (6.0 bar/87 psi)
- Axle load 9,000 kg: 700 kPa (7.0 bar/102 psi)

Load bearing index 164

- Axle load 6,300 kg: 425 kPa (4.25 bar/62 psi)
- Axle load 6,700 kg: 450 kPa (4.50 bar/65 psi)
- Axle load 7,100 kg: 500 kPa (5.0 bar/72 psi)
- Axle load 7,500 kg: 525 kPa (5.25 bar/76 psi)
- Axle load 8,000 kg: 575 kPa (5.75 bar/83 psi)
- Axle load 9,000 kg: 675 kPa (6.75 bar/98 psi)
- Axle load 9,500 kg: 725 kPa (7.25 bar/105 psi)
- Axle load 10,000 kg: 750 kPa (7.5 bar/109 psi)

Tyres 365/85 R 20

Load bearing index 164

- Axle load 6,300 kg: 450 kPa (4.50 bar/65 psi)
- Axle load 6,700 kg: 475 kPa (4.75 bar/69 psi)
- Axle load 7,100 kg: 525 kPa (5.25 bar/76 psi)
- Axle load 7,500 kg: 575 kPa (5.75 bar/83 psi)
- Axle load 8,000 kg: 625 kPa (6.25 bar/91 psi)
- Axle load 9,000 kg: 700 kPa (7.0 bar/102 psi)
- Axle load 9,500 kg: 750 kPa (7.5 bar/109 psi)
- Axle load 10,000 kg: 800 kPa (8.0 bar/116 psi)

Tyres 11 R 22.5

Load bearing index 148

- Axle load 6,300 kg: 850 kPa (8.5 bar/123 psi)

Tyres 12 R 22.5

Load bearing index 152

- Axle load 6,300 kg: 750 kPa (7.5 bar/109 psi)
- Axle load 6,700 kg: 800 kPa (8.0 bar/116 psi)
- Axle load 7,100 kg: 850 kPa (8.5 bar/123 psi)

Tyres 13 R 22.5

Load bearing index 154

- Axle load 6,300 kg: 700 kPa (7.0 bar/102 psi)
- Axle load 6,700 kg: 750 kPa (7.5 bar/109 psi)
- Axle load 7,100 kg: 800 kPa (8.0 bar/116 psi)
- Axle load 7,500 kg: 850 kPa (8.5 bar/123 psi)

Load bearing index 156

- Axle load 6,300 kg: 650 kPa (6.5 bar/94 psi)
- Axle load 6,700 kg: 725 kPa (7.25 bar/105 psi)
- Axle load 7,100 kg: 775 kPa (7.75 bar/112 psi)
- Axle load 7,500 kg: 825 kPa (8.25 bar/120 psi)
- Axle load 8,000 kg: 875 kPa (8.75 bar/127 psi)

Tyres 275/70 R 22.5

Load bearing index 148

- Axle load 6,300 kg: 900 kPa (9.0 bar/131 psi)

Load bearing index 150

- Axle load 6,300 kg: 825 kPa (8.25 bar, 120 psi)
- Axle load 6,700 kg: 900 kPa (9.0 bar, 131 psi)

Tyres 295/60 R 22.5

Load bearing index 150

- Axle load 6,300 kg: 850 kPa (8.5 bar/123 psi)
- Axle load 6,700 kg: 900 kPa (9.0 bar/131 psi)

Tyres 295/80 R 22.5

Load bearing index 150

- Axle load 6,300 kg: 750 kPa (7.5 bar/109 psi)
- Axle load 6,700 kg: 800 kPa (8.0 bar/116 psi)

Load bearing index 152

- Axle load 6,300 kg: 750 kPa (7.5 bar/109 psi)
- Axle load 6,700 kg: 800 kPa (8.0 bar/116 psi)
- Axle load 7,100 kg: 850 kPa (8.5 bar/123 psi)

Load bearing index 154

- Axle load 6,300 kg: 675 kPa (6.75 bar/98 psi)
- Axle load 6,700 kg: 750 kPa (7.5 bar/109 psi)
- Axle load 7,100 kg: 800 kPa (8.0 bar/116 psi)
- Axle load 7,500 kg: 850 kPa (8.5 bar/123 psi)

Tyres 305/70 R 22.5

Load bearing index 150

- Axle load 6,300 kg: 800 kPa (8.0 bar/116 psi)
- Axle load 6,700 kg: 850 kPa (8.5 bar/123 psi)

Load bearing index 152

- Axle load 6,300 kg: 775 kPa (7.75 bar/112 psi)
- Axle load 6,700 kg: 850 kPa (8.5 bar/123 psi)
- Axle load 7,100 kg: 900 kPa (9.0 bar/131 psi)

Tyres 315/60 R 22.5

Load bearing index 152

- Axle load 6,300 kg: 775 kPa (7.75 bar/112 psi)
- Axle load 6,700 kg: 850 kPa (8.5 bar/123 psi)
- Axle load 7,100 kg: 900 kPa (9.0 bar/131 psi)

Load bearing index 154

- Axle load 6,300 kg: 725 kPa (7.25 bar/105 psi)
- Axle load 6,700 kg: 800 kPa (8.0 bar/116 psi)
- Axle load 7,100 kg: 850 kPa (8.5 bar/123 psi)
- Axle load 7,500 kg: 900 kPa (9.0 bar/131 psi)

Tyres 315/70 R 22.5

Load bearing index 154

- Axle load 6,300 kg: 725 kPa (7.25 bar/105 psi)
- Axle load 6,700 kg: 800 kPa (8.0 bar/116 psi)
- Axle load 7,100 kg: 850 kPa (8.5 bar/123 psi)
- Axle load 7,500 kg: 900 kPa (9.0 bar/131 psi)

Load bearing index 156

- Axle load 6,300 kg: 675 kPa (6.75 bar/98 psi)
- Axle load 6,700 kg: 725 kPa (7.25 bar/105 psi)
- Axle load 7,100 kg: 775 kPa (7.75 bar/112 psi)
- Axle load 7,500 kg: 850 kPa (8.5 bar/123 psi)
- Axle load 8,000 kg: 900 kPa (9.0 bar/131 psi)

Tyres 315/80 R 22.5

Load bearing index 154

- Axle load 6,300 kg: 675 kPa (6.75 bar/98 psi)
- Axle load 6,700 kg: 725 kPa (7.25 bar/105 psi)

- Axle load 7,100 kg: 775 kPa (7.75 bar/112 psi)
- Axle load 7,500 kg: 825 kPa (8.25 bar/120 psi)

Load bearing index 156

- Axle load 6,300 kg: 650 kPa (6.5 bar/94 psi)
- Axle load 6,700 kg: 700 kPa (7.0 bar/102 psi)
- Axle load 7,100 kg: 750 kPa (7.5 bar/109 psi)
- Axle load 7,500 kg: 800 kPa (8.0 bar/116 psi)
- Axle load 8,000 kg: 850 kPa (8.5 bar/123 psi)

Tyres 355/50 R 22.5

Load bearing index 154

- Axle load 6,300 kg: 725 kPa (7.25 bar/105 psi)
- Axle load 6,700 kg: 800 kPa (8.0 bar/116 psi)
- Axle load 7,100 kg: 850 kPa (8.5 bar/123 psi)
- Axle load 7,500 kg: 900 kPa (9.0 bar/131 psi)

Load bearing index 156

- Axle load 6,300 kg: 675 kPa (6.75 bar/98 psi)
- Axle load 6,700 kg: 725 kPa (7.25 bar/105 psi)
- Axle load 7,100 kg: 775 kPa (7.75 bar/112 psi)
- Axle load 7,500 kg: 850 kPa (8.5 bar/123 psi)
- Axle load 8,000 kg: 900 kPa (9.0 bar/131 psi)

Tyres 365/70 R 22.5

Load bearing index 162

- Axle load 6,300 kg: 550 kPa (5.5 bar/80 psi)
- Axle load 6,700 kg: 600 kPa (6.0 bar/87 psi)
- Axle load 7,100 kg: 625 kPa (6.25 bar/91 psi)
- Axle load 7,500 kg: 675 kPa (6.75 bar/98 psi)
- Axle load 8,000 kg: 750 kPa (7.5 bar/109 psi)
- Axle load 9,000 kg: 850 kPa (8.5 bar/123 psi)
- Axle load 9,500 kg: 900 kPa (9.0 bar/131 psi)

Tyres 375/50 R 22.5

Load bearing index 156

- Axle load 6,300 kg: 675 kPa (6.75 bar/98 psi)
- Axle load 6,700 kg: 725 kPa (7.25 bar/105 psi)
- Axle load 7,100 kg: 775 kPa (7.75 bar/112 psi)
- Axle load 7,500 kg: 850 kPa (8.5 bar/123 psi)
- Axle load 8,000 kg: 900 kPa (9.0 bar/131 psi)

Tyres 385/55 R 22.5

Load bearing index 158

- Axle load 6,300 kg: 600 kPa (6.0 bar/87 psi)
- Axle load 6,700 kg: 650 kPa (6.5 bar/94 psi)
- Axle load 7,100 kg: 700 kPa (7.0 bar/102 psi)
- Axle load 7,500 kg: 750 kPa (7.5 bar/109 psi)
- Axle load 8,000 kg: 800 kPa (8.0 bar/116 psi)

Load bearing index 160

- Axle load 6,300 kg: 600 kPa (6.0 bar/87 psi)
- Axle load 6,700 kg: 625 kPa (6.25 bar/91 psi)
- Axle load 7,100 kg: 675 kPa (6.75 bar/98 psi)
- Axle load 7,500 kg: 725 kPa (7.25 bar/105 psi)
- Axle load 8,000 kg: 800 kPa (8.0 bar/116 psi)
- Axle load 9,000 kg: 900 kPa (9.0 bar/131 psi)

Tyres 385/65 R 22.5

Load bearing index 158

- Axle load 6,300 kg: 600 kPa (6.0 bar/87 psi)
- Axle load 6,700 kg: 650 kPa (6.5 bar/94 psi)
- Axle load 7,100 kg: 700 kPa (7.0 bar/102 psi)
- Axle load 7,500 kg: 750 kPa (7.5 bar/109 psi)
- Axle load 8,000 kg: 800 kPa (8.0 bar/116 psi)

Load bearing index 160

- Axle load 6,300 kg: 600 kPa (6.0 bar/87 psi)
- Axle load 6,700 kg: 625 kPa (6.25 bar/91 psi)
- Axle load 7,100 kg: 675 kPa (6.75 bar/98 psi)
- Axle load 7,500 kg: 725 kPa (7.25 bar/105 psi)
- Axle load 8,000 kg: 800 kPa (8.0 bar/116 psi)
- Axle load 9,000 kg: 900 kPa (9.0 bar/131 psi)

Load bearing index 162

- Axle load 8,000 kg: 750 kPa (7.5 bar/109 psi)
- Axle load 9,000 kg: 850 kPa (8.5 bar/123 psi)
- Axle load 9,500 kg: 900 kPa (9.0 bar/131 psi)

Load bearing index 164

- Axle load 6,300 kg: 525 kPa (5.25 bar/76 psi)
- Axle load 6,700 kg: 550 kPa (5.5 bar, 80 psi)
- Axle load 7,100 kg: 600 kPa (6.0 bar, 87 psi)
- Axle load 7,500 kg: 625 kPa (6.25 bar, 91 psi)
- Axle load 8,000 kg: 675 kPa (6.75 bar/98 psi)
- Axle load 9,000 kg: 800 kPa (8.0 bar/116 psi)
- Axle load 9,500 kg: 850 kPa (8.5 bar/123 psi)
- Axle load 10,000 kg: 900 kPa (9.0 bar/131 psi)

Tyres 425/65 R 22.5

Load bearing index 165

- Axle load 6,300 kg: 525 kPa (5.25 bar/76 psi)
- Axle load 6,700 kg: 550 kPa (5.5 bar/80 psi)
- Axle load 7,100 kg: 600 kPa (6.0 bar/87 psi)
- Axle load 7,500 kg: 625 kPa (6.25 bar/91 psi)
- Axle load 8,000 kg: 675 kPa (6.75 bar/98 psi)
- Axle load 9,000 kg: 750 kPa (7.5 bar/109 psi)
- Axle load 9,500 kg: 775 kPa (7.75 bar/112 psi)
- Axle load 10,000 kg: 825 kPa (8.25 bar/120 psi)

Tyres 495/45 R 22.5

Load bearing index 169

- Axle load 9,500 kg: 725 kPa (7.25 bar/105 psi)
- Axle load 10,000 kg: 750 kPa (7.5 bar/109 psi)
- Axle load 10,500 kg: 800 kPa (8.0 bar/116 psi)
- Axle load 11,500 kg: 900 kPa (9.0 bar/131 psi)

Tyres 12 R 24

Load bearing index 160

- Axle load 6,300 kg: 550 kPa (5.5 bar/80 psi)
- Axle load 6,700 kg: 600 kPa (6.0 bar/87 psi)
- Axle load 7,100 kg: 625 kPa (6.25 bar/91 psi)
- Axle load 7,500 kg: 675 kPa (6.75 bar/98 psi)
- Axle load 8,000 kg: 725 kPa (7.25 bar/105 psi)
- Axle load 9,000 kg: 850 kPa (8.5 bar/123 psi)

Tyres 325/95 R 24

Load bearing index 162

- Axle load 6,300 kg: 525 kPa (5.25 bar/76 psi)
- Axle load 6,700 kg: 550 kPa (5.5 bar/80 psi)
- Axle load 7,100 kg: 600 kPa (6.0 bar/87 psi)
- Axle load 7,500 kg: 625 kPa (6.25 bar/91 psi)
- Axle load 8,000 kg: 700 kPa (7.0 bar/102 psi)
- Axle load 9,000 kg: 800 kPa (8.0 bar/116 psi)
- Axle load 9,500 kg: 850 kPa (8.5 bar/123 psi)

Tyre pressure table for twin tyres

Tyres 12 R 20

Load bearing index 150

- Axle load 9,500 kg: 550 kPa (5.5 bar/80 psi)
- Axle load 10,000 kg: 600 kPa (6.0 bar/87 psi)
- Axle load 10,500 kg: 625 kPa (6.25 bar/91 psi)
- Axle load 11,500 kg: 700 kPa (7.0 bar/102 psi)
- Axle load 12,000 kg: 750 kPa (7.5 bar/109 psi)
- Axle load 12,300 kg: 775 kPa (7.75 bar/112 psi)
- Axle load 12,600 kg: 800 kPa (8.0 bar/116 psi)
- Axle load 13,000 kg: 825 kPa (8.25 bar/120 psi)
- Axle load 13,400 kg: 850 kPa (8.5 bar/123 psi)

Tyres 14 R 20

Load bearing index 157

- Axle load 9,500 kg: 350 kPa (3.5 bar/51 psi)
- Axle load 10,000 kg: 375 kPa (3.75 bar/54 psi)
- Axle load 10,500 kg: 400 kPa (4.0 bar/58 psi)
- Axle load 11,500 kg: 450 kPa (4.5 bar/65 psi)
- Axle load 12,000 kg: 475 kPa (4.75 bar/69 psi)
- Axle load 12,300 kg: 475 kPa (4.75 bar/69 psi)

- Axle load 12,600 kg: 500 kPa (5.0 bar/72 psi)
- Axle load 13,000 kg: 525 kPa (5.25 bar/76 psi)
- Axle load 13,400 kg: 550 kPa (5.5 bar/80 psi)
- Axle load 16,000 kg: 675 kPa (6.75 bar/98 psi)

Load bearing index 160

- Axle load 9,500 kg: 350 kPa (3.5 bar/51 psi)
- Axle load 10,000 kg: 375 kPa (3.75 bar/54 psi)
- Axle load 10,500 kg: 375 kPa (3.75 bar/54 psi)
- Axle load 11,500 kg: 425 kPa (4.25 bar/62 psi)
- Axle load 12,000 kg: 450 kPa (4.5 bar/65 psi)
- Axle load 12,300 kg: 475 kPa (4.75 bar/69 psi)
- Axle load 12,600 kg: 475 kPa (4.75 bar/69 psi)
- Axle load 13,000 kg: 500 kPa (5.0 bar/72 psi)
- Axle load 13,400 kg: 525 kPa (5.25 bar/76 psi)
- Axle load 16,000 kg: 650 kPa (6.5 bar/94 psi)

Tyres 11 R 22.5

Load bearing index 145

- Axle load 9,500 kg: 675 kPa (6.75 bar/98 psi)
- Axle load 10,000 kg: 725 kPa (7.25 bar/105 psi)
- Axle load 10,500 kg: 750 kPa (7.5 bar/109 psi)
- Axle load 11,500 kg: 850 kPa (8.5 bar/123 psi)

Tyres 12 R 22.5

Load bearing index 148

- Axle load 9,500 kg: 600 kPa (6.0 bar/87 psi)
- Axle load 10,000 kg: 650 kPa (6.5 bar/94 psi)
- Axle load 10,500 kg: 700 kPa (7.0 bar/102 psi)
- Axle load 11,500 kg: 775 kPa (7.75 bar/112 psi)
- Axle load 12,000 kg: 800 kPa (8.0 bar/116 psi)
- Axle load 12,300 kg: 825 kPa (8.25 bar/120 psi)
- Axle load 12,600 kg: 850 kPa (8.5 bar/123 psi)

Load bearing index 149

- Axle load 9,500 kg: 575 kPa (5.75 bar, 83 psi)
- Axle load 10,000 kg: 625 kPa (6.25 bar, 91 psi)
- Axle load 10,500 kg: 650 kPa (6.5 bar, 94 psi)
- Axle load 11,500 kg: 725 kPa (7.25 bar, 105 psi)
- Axle load 12,000 kg: 775 kPa (7.75 bar, 112 psi)
- Axle load 12,300 kg: 800 kPa (8.0 bar, 116 psi)
- Axle load 12,600 kg: 825 kPa (8.25 bar, 120 psi)
- Axle load 13,000 kg: 850 kPa (8.5 bar, 123 psi)

Tyres 13 R 22.5

Load bearing index 150

- Axle load 9,500 kg: 575 kPa (5.75 bar/83 psi)
- Axle load 10,000 kg: 625 kPa (6.25 bar/91 psi)
- Axle load 10,500 kg: 650 kPa (6.5 bar/94 psi)
- Axle load 11,500 kg: 725 kPa (7.25 bar/105 psi)

- Axle load 12,000 kg: 775 kPa (7.75 bar/112 psi)
- Axle load 12,300 kg: 800 kPa (8.0 bar/116 psi)
- Axle load 12,600 kg: 825 kPa (8.25 bar/120 psi)
- Axle load 13,000 kg: 850 kPa (8.5 bar/123 psi)
- Axle load 13,400 kg: 875 kPa (8.75 bar/127 psi)

Load bearing index 151

- Axle load 9,500 kg: 550 kPa (5.5 bar, 80 psi)
- Axle load 10,000 kg: 600 kPa (6.0 bar, 87 psi)
- Axle load 10,500 kg: 625 kPa (6.25 bar, 91 psi)
- Axle load 11,500 kg: 700 kPa (7.0 bar, 102 psi)
- Axle load 12,000 kg: 725 kPa (7.25 bar, 105 psi)
- Axle load 12,300 kg: 775 kPa (7.75 bar, 112 psi)
- Axle load 12,600 kg: 775 kPa (7.75 bar, 112 psi)
- Axle load 13,000 kg: 825 kPa (8.25 bar/120 psi)
- Axle load 13,400 kg: 850 kPa (8.5 bar/123 psi)

Tyres 275/70 R 22.5

Load bearing index 145

- Axle load 9,500 kg: 725 kPa (7.25 bar/105 psi)
- Axle load 10,000 kg: 750 kPa (7.5 bar/109 psi)
- Axle load 10,500 kg: 800 kPa (8.0 bar/116 psi)
- Axle load 11,500 kg: 900 kPa (9.0 bar/131 psi)

Tyres 295/55 R 22.5

Load bearing index 145

- Axle load 9,500 kg: 725 kPa (7.25 bar/105 psi)
- Axle load 10,000 kg: 750 kPa (7.5 bar/109 psi)
- Axle load 10,500 kg: 800 kPa (8.0 bar/116 psi)
- Axle load 11,500 kg: 900 kPa (9.0 bar/131 psi)

Tyres 295/60 R 22.5

Load bearing index 146

- Axle load 9,500 kg: 675 kPa (6.75 bar/98 psi)
- Axle load 10,000 kg: 725 kPa (7.25 bar/105 psi)
- Axle load 10,500 kg: 775 kPa (7.75 bar/112 psi)
- Axle load 11,500 kg: 875 kPa (8.75 bar/127 psi)
- Axle load 12,000 kg: 900 kPa (9.0 bar/131 psi)

Load bearing index 147

- Axle load 9,500 kg: 675 kPa (6.75 bar/98 psi)
- Axle load 10,000 kg: 700 kPa (7.0 bar/102 psi)
- Axle load 10,500 kg: 750 kPa (7.5 bar/109 psi)
- Axle load 11,500 kg: 850 kPa (8.5 bar/123 psi)
- Axle load 12,000 kg: 875 kPa (8.75 bar/127 psi)
- Axle load 12,300 kg: 900 kPa (9.0 bar/131 psi)

Tyres 295/80 R 22.5

Load bearing index 145

- Axle load 9,500 kg: 625 kPa (6.25 bar/91 psi)
- Axle load 10,000 kg: 675 kPa (6.75 bar/98 psi)

- Axle load 10,500 kg: 725 kPa (7.25 bar/105 psi)
- Axle load 11,500 kg: 800 kPa (8.0 bar/116 psi)

Load bearing index 148

- Axle load 9,500 kg: 600 kPa (6.0 bar/87 psi)
- Axle load 10,000 kg: 650 kPa (6.5 bar/94 psi)
- Axle load 10,500 kg: 700 kPa (7.0 bar/102 psi)
- Axle load 11,500 kg: 775 kPa (7.75 bar/112 psi)
- Axle load 12,000 kg: 800 kPa (8.0 bar/116 psi)
- Axle load 12,300 kg: 825 kPa (8.25 bar/120 psi)
- Axle load 12,600 kg: 850 kPa (8.5 bar/123 psi)

Load bearing index 149

- Axle load 9,500 kg: 575 kPa (5.75 bar/83 psi)
- Axle load 10,000 kg: 625 kPa (6.25 bar/91 psi)
- Axle load 10,500 kg: 650 kPa (6.5 bar/94 psi)
- Axle load 11,500 kg: 725 kPa (7.25 bar/105 psi)
- Axle load 12,000 kg: 775 kPa (7.75 bar, 112 psi)
- Axle load 12,300 kg: 800 kPa (8.0 bar/116 psi)
- Axle load 12,600 kg: 825 kPa (8.25 bar/120 psi)
- Axle load 13,000 kg: 850 kPa (8.5 bar/123 psi)

Tyres 305/70 R 22.5

Load bearing index 148

- Axle load 9,500 kg: 600 kPa (6.0 bar/87 psi)
- Axle load 10,000 kg: 650 kPa (6.5 bar/94 psi)
- Axle load 10,500 kg: 700 kPa (7.0 bar/102 psi)
- Axle load 11,500 kg: 775 kPa (7.75 bar/112 psi)
- Axle load 12,000 kg: 800 kPa (8.0 bar/116 psi)
- Axle load 12,300 kg: 825 kPa (8.25 bar/120 psi)
- Axle load 12,600 kg: 850 kPa (8.5 bar/123 psi)

Load bearing index 150

- Axle load 9,500 kg: 600 kPa (6.0 bar/87 psi)
- Axle load 10,000 kg: 625 kPa (6.25 bar/91 psi)
- Axle load 10,500 kg: 675 kPa (6.75 bar/98 psi)
- Axle load 11,500 kg: 750 kPa (7.5 bar/109 psi)
- Axle load 12,000 kg: 800 kPa (8.0 bar/116 psi)
- Axle load 12,300 kg: 825 kPa (8.25 bar/120 psi)
- Axle load 12,600 kg: 850 kPa (8.5 bar/123 psi)
- Axle load 13,000 kg: 875 kPa (8.75 bar, 127 psi)
- Axle load 13,400 kg: 900 kPa (9.0 bar, 131 psi)

Tyres 315/45 R 22.5

Load bearing index 145

- Axle load 9,500 kg: 725 kPa (7.25 bar/105 psi)
- Axle load 10,000 kg: 750 kPa (7.5 bar/109 psi)
- Axle load 10,500 kg: 800 kPa (8.0 bar/116 psi)
- Axle load 11,500 kg: 900 kPa (9.0 bar/131 psi)

Tyres 315/60 R 22.5

Load bearing index 148

- Axle load 9,500 kg: 650 kPa (6.5 bar/94 psi)
- Axle load 10,000 kg: 675 kPa (6.75 bar/98 psi)
- Axle load 10,500 kg: 725 kPa (7.25 bar/105 psi)
- Axle load 11,500 kg: 825 kPa (8.25 bar/120 psi)
- Axle load 12,000 kg: 850 kPa (8.5 bar/123 psi)
- Axle load 12,300 kg: 875 kPa (8.75 bar/127 psi)
- Axle load 12,600 kg: 900 kPa (9.0 bar/131 psi)

Load bearing index 150

- Axle load 9,500 kg: 600 kPa (6.0 bar, 87 psi)
- Axle load 10,000 kg: 625 kPa (6.25 bar, 91 psi)
- Axle load 10,500 kg: 675 kPa (6.75 bar, 98 psi)
- Axle load 11,500 kg: 750 kPa (7.5 bar, 109 psi)
- Axle load 12,000 kg: 775 kPa (7.75 bar, 112 psi)
- Axle load 12,300 kg: 825 kPa (8.25 bar/120 psi)
- Axle load 12,600 kg: 850 kPa (8.5 bar, 123 psi)
- Axle load 13,000 kg: 875 kPa (8.75 bar, 127 psi)
- Axle load 13,400 kg: 900 kPa (9.0 bar, 131 psi)

Tyres 315/70 R 22.5

Load bearing index 148

- Axle load 9,500 kg: 600 kPa (6.0 bar/87 psi)
- Axle load 10,000 kg: 650 kPa (6.5 bar/94 psi)
- Axle load 10,500 kg: 700 kPa (7.0 bar/102 psi)
- Axle load 11,500 kg: 775 kPa (7.75 bar/112 psi)
- Axle load 12,000 kg: 800 kPa (8.0 bar/116 psi)
- Axle load 12,300 kg: 825 kPa (8.25 bar/120 psi)
- Axle load 12,600 kg: 850 kPa (8.5 bar/123 psi)

Load bearing index 150

- Axle load 9,500 kg: 600 kPa (6.0 bar/87 psi)
- Axle load 10,000 kg: 625 kPa (6.25 bar/91 psi)
- Axle load 10,500 kg: 675 kPa (6.75 bar/98 psi)
- Axle load 11,500 kg: 750 kPa (7.5 bar/109 psi)
- Axle load 12,000 kg: 800 kPa (8.0 bar/116 psi)
- Axle load 12,300 kg: 825 kPa (8.25 bar/120 psi)
- Axle load 12,600 kg: 850 kPa (8.5 bar/123 psi)
- Axle load 13,000 kg: 875 kPa (8.75 bar/127 psi)
- Axle load 13,400 kg: 900 kPa (9.0 bar/131 psi)

Tyres 315/80 R 22.5

Load bearing index 150

- Axle load 9,500 kg: 575 kPa (5.75 bar/83 psi)
- Axle load 10,000 kg: 600 kPa (6.0 bar/87 psi)
- Axle load 10,500 kg: 650 kPa (6.5 bar/94 psi)
- Axle load 11,500 kg: 725 kPa (7.25 bar/105 psi)
- Axle load 12,000 kg: 750 kPa (7.5 bar/109 psi)
- Axle load 12,300 kg: 775 kPa (7.75 bar/112 psi)

- Axle load 12,600 kg: 800 kPa (8.0 bar/116 psi)
- Axle load 13,000 kg: 825 kPa (8.25 bar/120 psi)
- Axle load 13,400 kg: 850 kPa (8.5 bar/123 psi)

Tyres 12 R 24

Load bearing index 156

- Axle load 9,500 kg: 450 kPa (4.5 bar/65 psi)
- Axle load 10,000 kg: 475 kPa (4.75 bar/69 psi)
- Axle load 10,500 kg: 500 kPa (5.0 bar/72 psi)
- Axle load 11,500 kg: 575 kPa (5.75 bar/83 psi)
- Axle load 12,000 kg: 600 kPa (6.0 bar/87 psi)
- Axle load 12,300 kg: 625 kPa (6.25 bar/91 psi)
- Axle load 12,600 kg: 625 kPa (6.25 bar/91 psi)
- Axle load 13,000 kg: 675 kPa (6.75 bar/98 psi)
- Axle load 13,400 kg: 675 kPa (6.75 bar/98 psi)
- Axle load 16,000 kg: 850 kPa (8.5 bar/123 psi)

Tyres 325/95 R 24

Load bearing index 160

- Axle load 9,500 kg: 375 kPa (3.75 bar/54 psi)
- Axle load 10,000 kg: 425 kPa (4.25 bar/62 psi)
- Axle load 10,500 kg: 425 kPa (4.25 bar/62 psi)
- Axle load 11,500 kg: 500 kPa (5.0 bar/72 psi)
- Axle load 12,000 kg: 525 kPa (5.25 bar/76 psi)
- Axle load 12,300 kg: 550 kPa (5.5 bar/80 psi)
- Axle load 12,600 kg: 550 kPa (5.5 bar/80 psi)
- Axle load 13,000 kg: 575 kPa (5.75 bar/83 psi)
- Axle load 13,400 kg: 600 kPa (6.0 bar/87 psi)
- Axle load 16,000 kg: 725 kPa (7.25 bar/105 psi)

Useful information

These Operating Instructions describe all the models and standard and optional equipment of your vehicle that were available at the time of going to print. Country-specific differences are possible. Bear in mind that your vehicle may not be equipped with all the functions described. This also applies to safety-relevant systems and functions.

Read the information on qualified specialist workshops (▷ page 31).

Vehicle identification plate/axle loads

Vehicle identification plate and vehicle identification number (VIN)



Vehicle identification number (VIN) and vehicle identification plate (example: Actros cab with flat floor)

Vehicle identification plate ① is located in the door frame on the co-driver's side. Vehicle identification number (VIN) ② is stamped on the longitudinal frame member in the right wheel housing.

Information on the vehicle identification plate

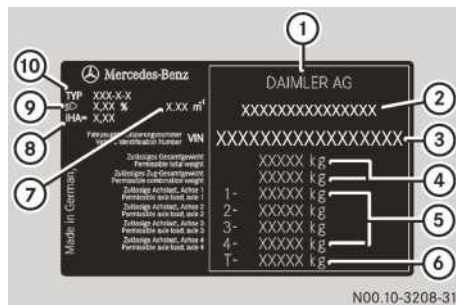

Example: vehicle identification plate

- ① Vehicle manufacturer (Daimler AG)
- ② EU general operating permit number (only in certain countries)
- ③ Vehicle identification number (VIN)
- ④ Permissible gross weight (kg)
Permissible gross vehicle combination weight (kg)
- ⑤ Permissible axle loads of axles 1 to 4 (kg)
- ⑥ Permissible load of axle group T (kg)
- ⑦ Flue gas coefficient
- ⑧ Rear axle ratio
- ⑨ Basic headlamp setting
- ⑩ Type of vehicle or vehicle model designation

You will find the technically permissible gross vehicle combination weight on the vehicle identification plate or in the COC documents. Note that, in ADR mode, the technically permissible gross vehicle combination weight is set by the continuous brake effect of the vehicle. You will find this value in your ADR certification.

If you require further assistance, consult a Mercedes-Benz Service Centre.

Engine data plate

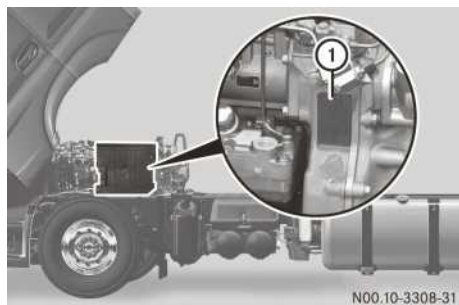

Example: OM 471 engine

Engine data plate ① is located at the rear of the crankcase on the left-hand side when viewed in the direction of travel.

Engine data plate ① contains the following information:

- Manufacturer
- Engine type
- Engine model series
- Engine number

i On vehicles with the OM 460 engine, the engine data plate is located on the crankcase on the right-hand side when viewed in the direction of travel.

Service products

Important safety notes

⚠ WARNING

Service product can be poisonous and hazardous to health. There is a risk of injury.

Observe the instructions on the respective original container when using, storing and disposing of service products. Always store service products in the sealed original container. Always keep service products out of the reach of children.

! Special additives (except approved fuel additives) are neither required nor approved for use with approved service products. Additives may cause damage to major assemblies. Therefore, do not mix any additives with ser-

vice products. You are responsible for the results of using fuel additives.

♻ Environmental note

Dispose of service products in an environmentally-responsible manner.

Service products are:

- windscreen washer concentrate
- fuels (e.g. diesel)
- AdBlue® (BlueTec® exhaust gas aftertreatment reduction agent)
- lubricants (e.g. engine oil, transmission oil, grease)
- hydraulic fluids
- coolant
- climate control system refrigerant

Approved service products fulfil the highest quality standards and are documented in the Mercedes-Benz Specifications for Service Products. For this reason, only use approved service products for your vehicle.

Information about approved service products is available from any Mercedes-Benz Service Centre.

You can recognise service products approved by Mercedes-Benz by the following inscription on the container:

- MB-Freigabe (e.g. MB-Freigabe 228.51)
or
- MB Approval (e.g. MB Approval 228.51)

Other labels and recommendations relating to the quality or indicating that the product meets a certain specification are not necessarily approved by Mercedes-Benz.

You can obtain further information from any Mercedes-Benz Service Centre.

i You can obtain information about service products that have been tested by Mercedes-Benz and approved for your vehicle on the Internet at: <http://bevo.mercedes-benz.com/>

The specification and availability of lubricants may vary. Some lubricants are no longer available, especially for older vehicles.

Information is available from any Mercedes-Benz Service Centre.

Engine oils

Notes on engine oils

! Engine oils other than those of the quality specified in this Operator's Manual are not permitted.



The quality of the engine oil is decisive for the function and service life of an engine. After extensive tests, Mercedes-Benz approves engine oils that correspond to the current technical standard.

For BlueTec[®]6 vehicles, only use engine oils which correspond to Mercedes-Benz Specifications for Service Products, Sheet No. 228.51 or 228.31.

For BlueTec[®]6 vehicles with Fuel Efficiency Package (FE1), use engine oils according to Sheet No. 228.61, 228.51 or 228.31.

For all other vehicles, you can use engine oils according to Sheet No. 228.5, 228.51, 228.3 or 228.31. Use the preferred engine oils according to Sheet No. 228.5 or 228.3.

Engine oils according to Sheet No. 228.51 have a higher quality standard and have a favourable effect on:

- length of oil change interval
- engine wear
- fuel consumption
- exhaust emissions

i You can find information on the quality grade, e.g. Sheet No. 228.51, and the viscosity, e.g. SAE class 5W-30, on the oil container.

Scope of use

Multi-grade engine oils that comply with Sheet No. 228.51 or 228.31 can be used all year round.

Depending on fuel quality (sulphur content or fatty acid methyl ester FAME), oil change intervals must be shortened.

Oil change

! If you mix engine oils with differing oil grades, the change interval for the engine oil is reduced in comparison to mixtures of engine oil of identical grade.

Therefore, only mix engine oils of differing grade in exceptional circumstances. To prevent damage to the engine, set the sheet number of the engine oil with the lower grade under **Engine oil grade**.

! If the SAE class (viscosity) of the engine oil used is not suitable for continually low outside temperatures below -20 °C, this could cause engine damage.

The specified temperatures of the SAE class always refer to freshly added oil. Engine oil ages during driving due to soot and fuel residue. This impairs the characteristics of the engine oil, particularly at low outside temperatures.

If the outside temperature is under -20 °C, Mercedes-Benz strongly recommends using engine oils of SAE class 5W-30 or 0W-30.

Use only all-season oils.

Environmental note

If you operate your vehicle using FAME fatty acid methyl ester fuel (bio-diesel), special precautions must be taken and national specifications complied with when disposing of engine oils. Information is available from any Mercedes-Benz Service Centre.

Oil change intervals are dependent on the following:

- the operating conditions of the vehicle
 - the grade of the engine oil used
 - the fuel type, e.g. FAME fatty acid methyl ester fuel
- ▶ Select the SAE viscosity class of the engine oil to suit the outside temperatures. Information on the SAE classes and outside temperature ranges can be found in Sheet No. 224.2 in the Mercedes-Benz Specification for Service Products.

The maximum oil change interval can only be achieved by using engine oils of particularly high quality in accordance with Sheet No. 228.51 of the Mercedes-Benz Specifications for Service Products. The on-board computer automatically shows the date of the next oil change.

Adding or topping up the engine oil

! There is a risk of damage to the catalytic converter or to the engine if too much oil is added. Have excess oil drained off.

When topping up, Mercedes-Benz recommends that you only use engine oil of the same grade and SAE class as the oil filled at the last oil change.

Check the oil level in the on-board computer (▷ page 148) before you top up the oil (▷ page 360).

Miscibility of engine oils

The benefits of high-quality engine oils are diminished if you mix them.

Engine oils are differentiated according to:

- engine oil brand
- quality grade (Sheet No.)
- SAE viscosity class

If, in exceptional circumstances, the type of engine oil currently used is not available, another engine oil approved for Mercedes-Benz may be used.

Setting the oil grade

! If the on-board computer shows the  symbol and you top up with the quantity of oil displayed in the on-board computer, note the following:

- If you top up with an engine oil of a lower quality, set the lower quality (Sheet no.) in the on-board computer.
 - If you top up with an engine oil of a higher quality, do not set the higher quality (Sheet no.) in the on-board computer.
- ▶ Set the Sheet No. (quality grade) of the engine oil in the on-board computer (▷ page 150).

Transmission oils

General notes

At the factory, drive axles, transmission and the PTO shaft gear are filled with a high-quality synthetic oil.

The planetary axles are filled with mineral oil.

Only use:

- transmission oils which comply with Sheet No. 236.91 for automatic transmissions
- transmission oils which comply with Sheet No. 235.11 for automated manual transmissions

! When changing the oil, if you replace the synthetic oil with a mineral transmission oil, you may damage the assembly. Before the oil change, check whether the use of a mineral transmission oil is permitted. Information is available from any Mercedes-Benz Service Centre.

Transmission oil grade

The quality grade (Sheet No.) of the transmission oil used can be checked in the on-board computer (▷ page 151).

Coolant

WARNING

If antifreeze comes into contact with hot components in the engine compartment, it may ignite. There is a risk of fire and injury.

Let the engine cool down before you top up the antifreeze. Make sure that antifreeze is not spilled next to the filler neck. Thoroughly clean the antifreeze from components before starting the engine.

A coolant that ensures anti-corrosion/anti-freeze protection and other important protective effects is added at the factory.

The coolant is a mixture of water and corrosion inhibitor/antifreeze.

The corrosion inhibitor/antifreeze in the coolant has the following properties:

- heat transfer
- anti-corrosion protection

- cavitation protection (protection against pitting)
- antifreeze protection
- raising the boiling point

Leave the coolant/antifreeze in the engine cooling system all year round – even in countries with high outside temperatures.

Check the corrosion inhibitor/antifreeze concentration in the coolant every six months.

Only use approved corrosion inhibitors/antifreeze agents in accordance with Sheet No. 325.5. This prevents damage to the engine cooling system and engine.

When renewing the coolant, ensure that it contains 50% antifreeze/corrosion inhibitor by volume. This corresponds to antifreeze protection down to -37 °C.

Do not exceed 55% by volume (antifreeze down to approximately -45 °C). The heat dissipation and antifreeze may otherwise be negatively affected.

If there is a loss of coolant, do not top it up by using only water, also add an approved corrosion inhibitor/antifreeze agent.

The water in the coolant must meet certain requirements which are often met by drinking water. The water must be treated if its quality does not meet the required standards.

Do not mix the water and the antifreeze/anti-corrosion additive in the coolant circuit. Afterwards, fill the coolant expansion tank with the mixture.

Avoid mixing different corrosion inhibitor/antifreeze agents.

Observe the Mercedes-Benz Specifications for Service Products, Sheet No. 310.1.

Further information about operational and road safety can be obtained from any Mercedes-Benz Service Centre.

Refrigerant

Important safety notes

Your vehicle's climate control system is filled with R-134a refrigerant and contains fluorinated greenhouse gas.

The instruction label regarding the refrigerant type used can be found behind the maintenance flap.

- ❗ Only the refrigerant R-134a and the PAG oil approved by Mercedes-Benz may be used. The approved PAG oil may not be mixed with any other PAG oil that is not approved for R-134a refrigerant. The climate control system may otherwise be damaged.

Maintenance work such as refilling refrigerant or replacing components may only be carried out at a qualified specialist workshop. All applicable regulations as well as SAE standard J639 must be adhered to.

Always have all work on the climate control system carried out at a qualified specialist workshop.

Refrigerant instruction label

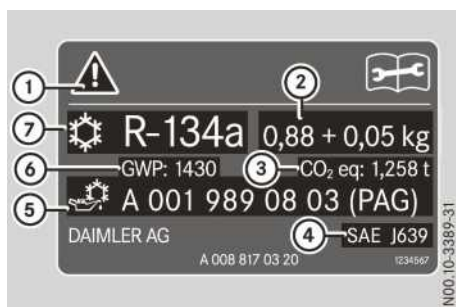

Example: refrigerant instruction label

- ① Symbols for hazard and service information
- ② Refrigerant filling capacity
- ③ CO₂ equivalent of the refrigerant used
- ④ Applicable standards
- ⑤ PAG oil part number
- ⑥ GWP (global warming potential) of the refrigerant used
- ⑦ Refrigerant type

Symbols ① advise you about:

- possible dangers
- having service work carried out at a qualified specialist workshop

Notes on fuel grade for vehicles with a diesel engine

Observe the notes on service products .

WARNING

If you mix diesel fuel with petrol, the flash point of this fuel mixture is lower than that of pure diesel fuel. When the engine is running, components in the exhaust system may over-heat unnoticed. There is a risk of fire.

Never refuel with petrol. Never add petrol to diesel fuel.

Even small amounts of the wrong fuel may cause damage to the fuel system, engine and emission control system.

! Refuel only with commercially available vehicle diesel fuel that conforms to the European standard EN 590 (or equivalent national fuel standards).

! **Vehicles with diesel particle filters:** in countries outside the EU, only use low sulphur Euro diesel with a sulphur content of under 50 ppm. Otherwise, the emission control system could be damaged.

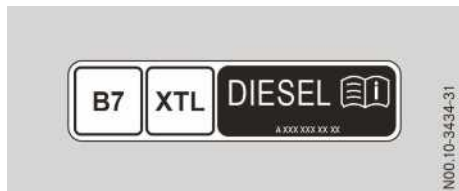

Compatibility labels for all vehicles



Compatibility labels only for BlueTec® vehicles with OM471 engines (code MOW)

You will find the compatibility labels on the tensioning strap of the fuel tank and on the fuel pump or on the fuel pump nozzle of the filling station

- **B7:** for diesel fuel with a maximum of seven % bio-diesel (fatty acid methyl ester) by volume
- **B10:** for diesel fuel with a maximum of ten % bio-diesel (fatty acid methyl ester) by volume

- **B20:** for diesel fuel with a maximum of twenty % bio-diesel (fatty acid methyl ester) by volume
- **B30:** for diesel fuel with a maximum of thirty % bio-diesel (fatty acid methyl ester) by volume
- **B100:** for diesel fuel with a maximum of one hundred % bio-diesel (fatty acid methyl ester) by volume
- **XTL:** for paraffinic diesel fuel in accordance with EN 15940

Notes on low outside temperatures

Refuel your vehicle at the beginning of the winter until the tank is as full as possible with winter diesel.

Before switching to winter diesel, the fuel tank must be as empty as possible. Keep the fuel level low when refuelling the vehicle with winter diesel for the first time, e.g. reserve level. The next time you refuel the vehicle, the fuel tank may be filled up to a normal level again.

You can obtain further information on fuel:

- at a filling station
- at a qualified specialist workshop

Diesel fuels in accordance with EN 590

Important safety notes

WARNING

Fuel is highly flammable. When fuel is handled improperly, there is a risk of fire and explosion.

Avoid fire, naked flames, smoking and the creation of sparks. Make sure that fuels do not come into contact with a hot exhaust system. Before carrying out work on the fuel system, switch off the ignition and the auxiliary heater. Always wear protective gloves.

! If you are using drums or canisters to refuel the vehicle, you should filter the fuel before adding it.

This will prevent malfunctions in the fuel system due to contaminated fuel.

i **BlueTec®6 vehicles:** refuel only with commercially available sulphur-free diesel fuel according to the European standard EN 590

as of 2010 with max. 0.001 wt% (10 ppm) sulphur content.

The following fuel types are not permitted:

- sulphurous fuel with a sulphur content over 0.001 wt%
- marine diesel fuel
- aviation turbine fuel
- heating oils
- FAME fatty acid methyl ester (bio-diesel fuel)⁷

These fuel types cause irreversible damage to the engine and BlueTec[®]6 exhaust gas after-treatment, as well as also significantly reducing the expected service life.

i BlueTec[®]4 vehicles and BlueTec[®]5 vehicles: the diesel fuel must comply with the European standard EN 590. This enables the engines to attain the specified performance as well as legally prescribed emission levels of the Euro 4 and Euro 5 standards.

The use of fuels with a sulphur content over 0.005 wt% (50 ppm) reduces the life expectancy of the engine and exhaust system.

The following fuel types are not permitted:

- sulphurous fuel with a sulphur content over 0.05 wt% (500 ppm)
- marine diesel fuel
- aviation turbine fuel
- heating oils
- FAME fatty acid methyl ester (bio-diesel fuel) > 7% by volume

i Vehicles without BlueTec[®] exhaust gas aftertreatment: refuel only with commercially available sulphur-free diesel fuel that conforms to the European standard EN 590 as of 2010 or a comparable national fuel standard.

This enables the engines to attain the specified performance as well as legally prescribed emission levels of the Euro -3 standard.

The following fuel types are not permitted:

- OM 460: sulphurous fuel with a sulphur content over 0.2 wt% (2000 ppm)
- OM 473: sulphurous fuel with a sulphur content over 0.1 wt% (1000 ppm)
- marine diesel fuel
- aviation turbine fuel

- heating oils
- FAME fatty acid methyl ester (bio-diesel fuel) > 7% by volume

! A high fuel sulphur content accelerates the ageing process of the engine oil and can damage the engine and exhaust system.

On vehicles without BlueTec[®] exhaust gas after-treatment, the fuel sulphur content is set to the standard value for the country of delivery. If you refuel using diesel fuel with a different sulphur content, select the new value for the sulphur content in the on-board computer (> page 150). If you do not know the sulphur content of the diesel fuel you are using, select the least favourable value for the sulphur content in the on-board computer.

Information regarding the current country-specific sulphur content can be obtained from any Mercedes-Benz Service Centre or found in the Mercedes-Benz Specification for Service Products, Sheet No. 136.1 or 136.2.

Certain countries have diesel fuel with varying sulphur content. Diesel fuel with low sulphur content is sold in certain countries under the name "Euro diesel".

Diesel fuels at low temperatures

WARNING

If you heat fuel system components, e.g. with a hot-air gun or naked flame, these components could be damaged. This can cause fuel to escape and ignite. Depending on the type of damage, fuel may also not escape until the engine is running. There is a risk of fire and explosion.

Never heat fuel system components. Contact a qualified specialist workshop to rectify the malfunction.

At low outside temperatures, paraffin separation may cause the flow properties of the diesel fuel to be insufficient.

To prevent operating problems, diesel fuel with improved flow properties is available in the winter months.

Winter diesel fuels are reliable down to outside temperatures of -22 °C in Germany and other central European countries. You can normally

⁷ Except for vehicle code (M0W).

use winter diesel fuel without problems at the outside temperatures expected in the country where it is on sale.

The vehicle may be equipped with a fuel preheating system. The fuel preheating system warms up the fuel and thereby improves its flow characteristics.

Fuel additives

! Do not use any fuel additive. Fuel additives may cause malfunctions and engine failure.

Do not add any petrol, kerosene or flow improvers to diesel fuel to improve its flow characteristics. Flow improvers actually impair the lubricity of the diesel fuel. This can cause damage to the injection system, for example.

Bio-diesel fuels in accordance with DIN EN 14214

UCOME (Used Cooking Oil Methyl Ester)

The vehicle must not be run on bio-diesel approved in accordance with DIN EN 14214 which has been manufactured from used cooking oil/cooking fat = UCOME (Used Cooking Oil Methyl Ester).

FAME fatty acid methyl ester fuel

Operation with FAME fatty acid methyl ester fuel is only permitted for BlueTec® vehicles with OM471 engines (code M0W). A special fuel pre-filter (code M8Y) must be fitted on these vehicles. Information regarding this can be obtained from any qualified specialist workshop.

Observe the safety notes on service products. Operate your vehicle using pure FAME fatty acid methyl ester fuel in compliance with DIN EN 14214. You can also operate your vehicle using a mixture of conventional diesel fuel in compliance with EN 590 and FAME fatty acid methyl ester fuel.

Observe the specifications in accordance with Sheet No. 135 of the Mercedes-Benz Specifications for Service Products for operation with FAME fatty acid methyl ester fuel.

Operating the vehicle with FAME fatty acid methyl ester fuel results in a slightly higher fuel consumption.

Observe the following when using FAME fatty acid methyl ester fuel:

- the intervals for oil, fuel filter and oil filter changes are noticeably shorter.
- have the fuel and oil filter replaced at every oil change.

Have the oil, oil filter and fuel filter replaced according to the specified intervals or every six months at the latest.

- replace the fuel filter every 30,000 km
- replace the oil and oil filter every 60,000 km
- only add FAME fatty acid methyl ester fuel as per DIN EN 14214. Fuel additives that do not comply with the DIN EN 14214 standard could cause malfunctions or engine damage.
- FAME fatty acid methyl ester fuel attacks painted surfaces. Therefore, do not allow FAME fatty acid methyl ester fuel to affect the paintwork. Immediately rinse FAME fatty acid methyl ester fuel with water.
- during long periods out of use, FAME fatty acid methyl ester fuel can cause fuel system components to stick together. Therefore, use all of the FAME fatty acid methyl ester fuel before long periods when the engine is out of use. Fill the fuel tank with conventional diesel fuel and allow the engine to run before parking the vehicle.
- FAME fatty acid methyl ester is subject to a natural ageing process. Mercedes-Benz recommends that you do not fill up vehicles with long periods out of use, e.g. fire engines, with FAME fatty acid methyl ester fuel.

Low outside temperatures

For temperatures below 5 °C, Mercedes-Benz recommends switching from using fatty acid methyl ester FAME fuel to conventional diesel fuel.

The replacement interval for the fuel filter may be significantly shortened depending on the raw materials used and method of production of FAME fatty acid methyl ester fuels. The cold start ability is also reduced.

Alternative diesel fuels in accordance with DIN EN 15940

Observe the safety notes on service products.

Alternative diesel fuels in accordance with DIN EN 15940 may be manufactured from:

- hydrotreated vegetable oils (HVO – Hydro-treated Vegetable Oils)
- biomass (BtL – Biomass-to-Liquid)
- natural gas (GtL – Gas-to-Liquid)
- coal (CtL – Coal-to-Liquid)

Alternative diesel fuels in accordance with DIN EN 15940 can be used in the following engines:

- OM470
- OM471
- OM473
- OM936

Your vehicle can be operated with pure alternative diesel fuels in accordance with DIN EN 15940 and mixtures of conventional diesel fuels and alternative diesel fuels in accordance with DIN EN 15940.

AdBlue®

AdBlue® notes

! Only use AdBlue®/DEF in accordance with DIN 70070/ISO 2224 1. Do not use any additives.

If AdBlue®/DEF comes into contact with painted or aluminium surfaces when filling the tank, rinse the affected area immediately with plenty of water.

If the AdBlue® tank still contains enough AdBlue®, pressure compensation may occur when the tank lid is unscrewed. AdBlue® may spill out. Therefore, open the AdBlue® tank lid carefully. If AdBlue® spills out, immediately wash the affected area with plenty of water.

AdBlue® is a non-flammable, non-toxic, colourless, odourless and water-soluble liquid.

When opening the AdBlue® tank, small amounts of ammonia vapours could escape.

Ammonia vapours have a pungent smell and are particularly irritating to:

- skin
- mucous membranes
- eyes

The vapours may cause a burning sensation in the eyes, nose and throat as well as irritation of the throat and watering eyes.

Avoid inhaling ammonia vapours. Only fill the AdBlue® tank in well-ventilated areas.

AdBlue® should not come into contact with skin, eyes or clothing, and should not be swallowed. Keep AdBlue® out of the reach of children.

If you come into contact with AdBlue®, observe the following:

- Immediately wash AdBlue® from your skin with water and soap.
- If AdBlue® comes into contact with your eyes, rinse your eyes with clean water immediately. Consult a doctor without delay.
- If you have swallowed AdBlue®, immediately rinse your mouth with water and drink plenty of water. Consult a doctor without delay.
- Change clothing that is soiled with AdBlue® immediately.

High outside temperatures

The chemical composition of AdBlue® can break down if it heats up to 50 °C over a long period of time (e.g. as a result of direct sunlight on the tank). This creates ammonia vapour.

Low outside temperatures

AdBlue® freezes at a temperature of approximately -11 °C. The vehicle's AdBlue® supply system is fitted with a fully-automatic heating system. Winter operation is therefore also ensured for temperatures below -11 °C.

Additives, tap water

! Do not mix additives with AdBlue®. Do not dilute AdBlue® with tap water. This could destroy the BlueTec® exhaust gas aftertreatment system.

Storage

! Containers made of the following materials are not suitable for the storage of AdBlue®/DEF:

- aluminium
- copper
- copper alloys

- unalloyed steel
- galvanised steel

If AdBlue® is stored in these types of container, constituents of these metals may dissolve and damage the BlueTec® exhaust gas aftertreatment beyond repair.

Only use containers made of the following materials to store AdBlue®:

- Cr-Ni steel in accordance with DIN EN 10 088-1/2/3
- Mo-Cr-Ni steel in accordance with DIN EN 10 088-1/2/3
- Polypropylene
- Polyethylene

Disposal



Environmental note

Dispose of AdBlue® in an environmentally responsible manner.

Observe the legal requirements for the country you are currently in when disposing of AdBlue®.

Purity

I Impurities in AdBlue®, e.g. due to other service products, cleaning products or dust, may lead to:

- increased emission values
- damage to the catalytic converter
- engine damage
- malfunctions in the BlueTec® exhaust gas aftertreatment

Ensure that AdBlue® is always pure to avoid malfunctions in BlueTec® exhaust gas aftertreatment.

If AdBlue® is pumped from the AdBlue® tank, e.g. during repairs, do not use this fluid to refill the tank. Otherwise, the purity of the fluid would no longer be guaranteed.

Operating data

Compressed-air system

Minimum pressures	in bar
Brake circuit 1	6.8
Brake circuit 2	6.8
Brake circuit 3	5.5
Transmission circuit/clutch circuit	5.5
Spring-loaded parking brake cylinder release pressure	6.5

Reservoir pressures	in bar
Service brake	10.5 - 13.6
Pneumatic suspension	10.5 - 15.5
External compressed-air source (charging the compressed-air system)	11.0 - 12.5
Remaining pressure circuits	7.0 - 8.7

Engine

OM 936 engine with 7698 cm³

Idling speed	Approximately 600 rpm
Engine brake (operating range)	Approximately 1000 - 3000 rpm
Engine speed range of maximum torque	Approximately 1200 - 1600 rpm
Engine speed of maximum power output	Approximately 2200 rpm

OM 460 engine with 12816 cm³

Idling speed	Approximately 560 - 800 rpm
Engine brake (operating range)	Approximately 1500 - 2500 rpm
Engine speed of maximum power output	Approximately 1600 rpm

OM 470 engine with 10667 cm³ and OM 471 engine with 12809 cm³

Idling speed	Approximately 500 - 550 rpm
Engine brake (operating range)	Approximately 1000 - 2300 rpm
Engine speed at maximum torque	Approximately 1100 rpm
Engine speed of maximum power output	Approximately 1600 - 1800 rpm

OM 473 engine with 15569 cm³

Idling speed	Approximately 500 rpm
Engine brake (operating range)	Approximately 1000 - 2300 rpm
Engine speed at maximum torque	Approximately 1100 rpm
Engine speed of maximum power output	Approximately 1600 rpm

Operating temperature

OM 936

Normal operation	Approximately 80 - 100 °C
Maximum permissible coolant temperature in operation	Up to 103 °C
Automatically reduced engine power output	From 103 °C

OM 460

Normal operation	Approximately 80 - 95 °C
Maximum permissible coolant temperature in operation	Up to 110 °C
Automatically reduced engine power output	From 105 °C

OM 470, OM 471, OM 473

Normal operation	Approximately 85 - 105 °C
Maximum permissible coolant temperature in operation	Up to 110 °C
Automatically reduced engine power output	From 110 °C

Tyre pressures

Tyre pressure table for single tyres	(▷ page 406)
Tyre pressure table for twin tyres	(▷ page 411)
Permissible difference in pressure between tyres on an axle	20 kPa (0.2 bar / 3 psi)
Maximum permissible air pressure for inflating tyres	1000 kPa (10.0 bar / 145 psi)

Wheel nut tightening torques

The tightening torques for the wheel nuts are identical for light-alloy and steel wheels.

Wheel nuts with pressure plate (hub centring) M22x1.5 for 20", 22.5" and 24" wheels 10-hole mounting	600 Nm
Wheel nuts with pressure plate (hub centring) M18x1.5 for 17.5" wheels 6-hole mounting	400 Nm
Wheel nuts with spherical spring washer	450 Nm
Connecting flange with twin tyres 14.00 R 20	450 Nm
Wheel nut caps	60 Nm

Spring-loaded cylinder

Release torque of the spring-loaded parking brake cylinder release screw	Maximum 70 Nm
Tightening torque of the spring-loaded parking brake cylinder release screw	Maximum 35 Nm
Release pressure (with external source of compressed air)	Minimum 6.5 bar

Level control

Fill the air suspension via connection 28 on the electronic air processing unit	Maximum 12.5 bar
---	---------------------

Compressed-air reservoir

Information on the compressed-air reservoir

For the initial purchaser and other users
Accompanying documentation in accordance with Directive 2009/105/EC of the European Parliaments and Council and in accordance with the technical standard EN 286-2.

The reservoir is:

- a – only intended for use in compressed-air systems and auxiliary equipment on motor vehicles and their trailers, and is only to be used to hold compressed air.
- b – to be marked for identification with a works number and the reservoir manufacturer's name, together with the principal operating data and the EC mark; see the identification plate or engravings directly on the reservoir wall.
- c – to be manufactured with a "Declaration of conformity" in accordance with Article 12 of Directive 2009/105/EC.
- d – to be secured to the vehicle by tensioning straps (clamps).

In the case of aluminium reservoirs, contact surfaces must be designed to inhibit corrosion or mechanical damage. Tensioning straps are to be secured in such a way that they do not come in contact with the base connecting seams; the reservoir is not to be subjected to any stress that would jeopardise operating safety.

Coatings applied to aluminium reservoirs must not contain lead, and the top coat of paint must only be applied over a suitable primer coat. Steel threaded connections for aluminium reservoirs must have a corrosion-proof coating.

- only to be cleaned using non-alkaline cleaning agents (aluminium reservoirs).
- to have the interior visible through the threaded connections.
- to be emptied at regular intervals to prevent the accumulation of condensation (pull ring on release valve at the lowest point of the reservoir).
- e – to require no maintenance if item d is complied with.
- f – no welding, heat treatment or other operation relevant to safety is to be performed on the pressure-bearing walls of the reservoir (casing, base, ring nuts).
- g – the internal supply pressure may exceed the maximum operating pressure P_s by no more than 10% for a brief period.

Daimler AG

Compressed-air reservoir identification plates

Aluminium reservoir

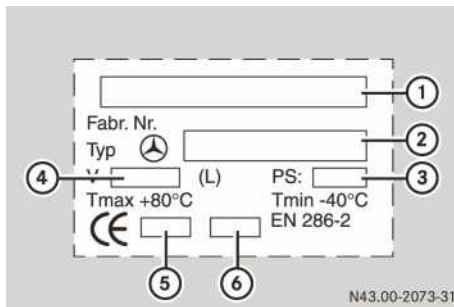

Example: identification plate on the aluminium reservoir

- ① Manufacturer: SAG (Austria)
- ② MB part number
- ③ Maximum operating pressure (bar)
- ④ Volume (litres)
- ⑤ Testing establishment code number
- ⑥ Year of construction

Steel reservoir

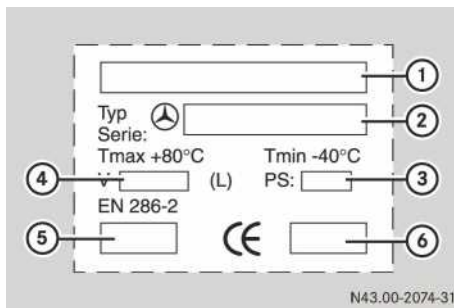

Example: identification plate on the steel reservoir

- ① Manufacturer:
frauenthal automotive
Erhard
- ② MB part number
- ③ Maximum operating pressure (bar)
- ④ Volume (litres)
- ⑤ Year of construction
- ⑥ Testing establishment code number

Publication details

Internet

Further information about Mercedes-Benz vehicles and about Daimler AG can be found on the following websites:

<http://www.mercedes-benz.com>

<http://www.daimler.com>

FleetBoard Support

If you have questions concerning your FleetBoard vehicle computer, contact FleetBoard Support:

Telephone +49 711 17 91 999

Address Daimler FleetBoard GmbH,
HPC: Z400, 70546 Stuttgart, Germany

Internet www.fleetboard.com

E-mail support@fleetboard.com

Documentation team

You are welcome to forward any queries or suggestions you may have regarding these Operating Instructions to:

Daimler AG, HPC: CAC, Customer Service,
70546 Stuttgart, Germany

© Daimler AG: reprinting, translation and reproduction, even in part, is forbidden without written permission from Daimler AG.

Vehicle manufacturer

Daimler AG
Mercedesstraße 137
70327 Stuttgart
Germany



9605849581

Order no. 6462 9533 02 Part no. 960 584 95 81 Edition 09b-17